



SOLUTIONS FOR EDUCATIONAL ENVIRONMENTS



School's In!
Sound and **Safety** in a
single integrated system.

Who is TOA?

Organizations search for the right combination of developing innovative solutions, obtaining a global reach, and realizing satisfied employees. TOA's corporate vision and key management goals produce the healthy environment that permits our organization to achieve these objectives. Our commitment to quality products through strong team collaboration and meticulous work ethic has created a well respected world brand.

Established in 1934 in Kobe, Japan, our company prides itself on its longevity, experience and reputation. Throughout the decades, TOA has steadily expanded its expertise and accomplished many technological advancements. From the design and engineering phase followed by our quality controlled manufacturing process our team of dedicated staff continue to enhance our product lineup.



TOA Canada was incorporated in 1990, bringing with it the values and commitment of our Japanese colleagues. We focus on reliable and high performance equipment and delivering excellent customer service to the Canadian market. Uniquely positioned to support security, communication, and professional audio in various markets, we ensure our customers are satisfied with the sound solution we deliver.



Dr. Sound Knows Education

Our global ambassador, Dr. Sound, an expert in audio and communication solutions, knows a thing or two about outfitting schools with the right equipment. He values the importance of a nourishing school environment and absolutely believes in our equipment's ability to enhance that learning.

	sound expert	
friendly service		techtips@drsound.ca

Our Education Advantage

Technology continues to insert itself into the classroom more and more. TOA Canada's successful infrared wireless classroom voice-lift system, the IR-800, has been a bright light for students in many school boards across Canada.

Classroom audio distribution systems (CADS), formerly known as sound field amplification systems, should be used, when appropriate, to achieve clearer speech signals (Larsen & Blair, 2008). With these systems, the signal level is greatly improved since only the voice at the microphone is amplified, not the background noise.¹

¹ SAC, Speech-Language & Audiology Canada, SAC position paper on Classroom Acoustics, May 2019



School administrators acknowledge the impact that voice lift systems provide for those in the school ecosystem. Teachers provide a very important service; ensuring they can continue to deliver their message with an intelligible voice is key. By implementing the infrared voice lift system with microphone and wide-dispersion speaker, teachers do not need to raise their voices to reach all areas of the room. The system distributes their voice evenly and clearly throughout the classroom with very little effort. This results in lower vocal fatigue and increased stamina. Educators can feel confident that their lessons are being heard by the students, reduces their stress levels.

It is well known that students who sit at the front of the class can hear the teacher better than those who sit further back. This is even more apparent when the teacher is facing the chalkboard. Student success will be hampered if the presented material is not being absorbed. The IR-800 system supports full classroom learning by dispersing the information to all students equally. The magnitude of this effect will be noticed with more engaged students and increased grades.



While IR-800 is designed to help create an ideal environment for student success, it also significantly reduces vocal fatigue for teachers. This forms a win-win effect for education in Canadian schools, improving both student learning and the occupational health and safety of teachers.

Classroom Voice Lift

TOA strives to enhance the environment within educational facilities to improve student learning and increase voice intelligibility throughout the building and multi-campus locations. Students spend the majority of their time at school in a classroom; this directed TOA to focus on their setting. The development of our IR-800 voice lift system and recent second generation IR-800 Plus, has firmly implanted TOA's footprint in the education market.

Infrared wireless microphone system

Due to the fact that these microphones operate on infrared frequencies rather than radio frequencies, they are free to operate without interference from wireless systems in neighboring classrooms for clear, uninterrupted communication, and there is no limit to the number of active systems that can operate without interference in any building. Available in handheld and lanyard types with the option of connecting a headset or lavalier, TOA infrared microphones feature high sound quality for excellent intelligibility, and extended battery life for operation up to eight hours. A wide coverage receiver is built in for stable voice transmission in various classroom sizes. An ALD (Assisted Listening Device) output with level control provides audio feed to external systems for children who require it.



Wide-dispersion Ceiling Speakers

The IR-820SP speaker utilizes a wide dispersion coverage pattern to deliver clear speech intelligibility to every student, no matter where in the room they may be seated. This characteristic also reduces the number of speakers that need to be installed to cover the same wide area. Sound dissemination is even throughout the space, allowing for a comfortable and stress-free learning environment where students can flourish with increased comprehension. The IR-820SP Speaker design also blends in unobtrusively with any decor.

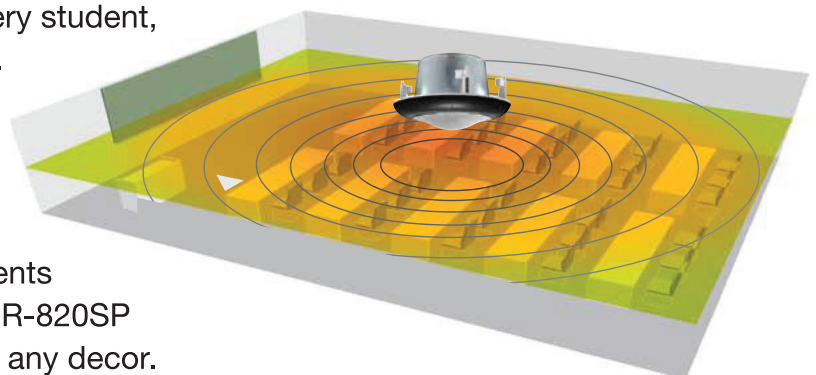

With the feedback we received from teachers and school boards, TOA augmented the successful IR-800 system to maximize its flexibility in educational environments. With the addition of an interface unit, the voice lift system can now be designed to suit various classroom configurations. For larger classrooms, you now have the option of installing two speakers. The IR-801AF interface also allows for Room Combining and Division in rooms with a removable wall, transitioning smoothly from a single large system into two separate systems with the flip of a switch.

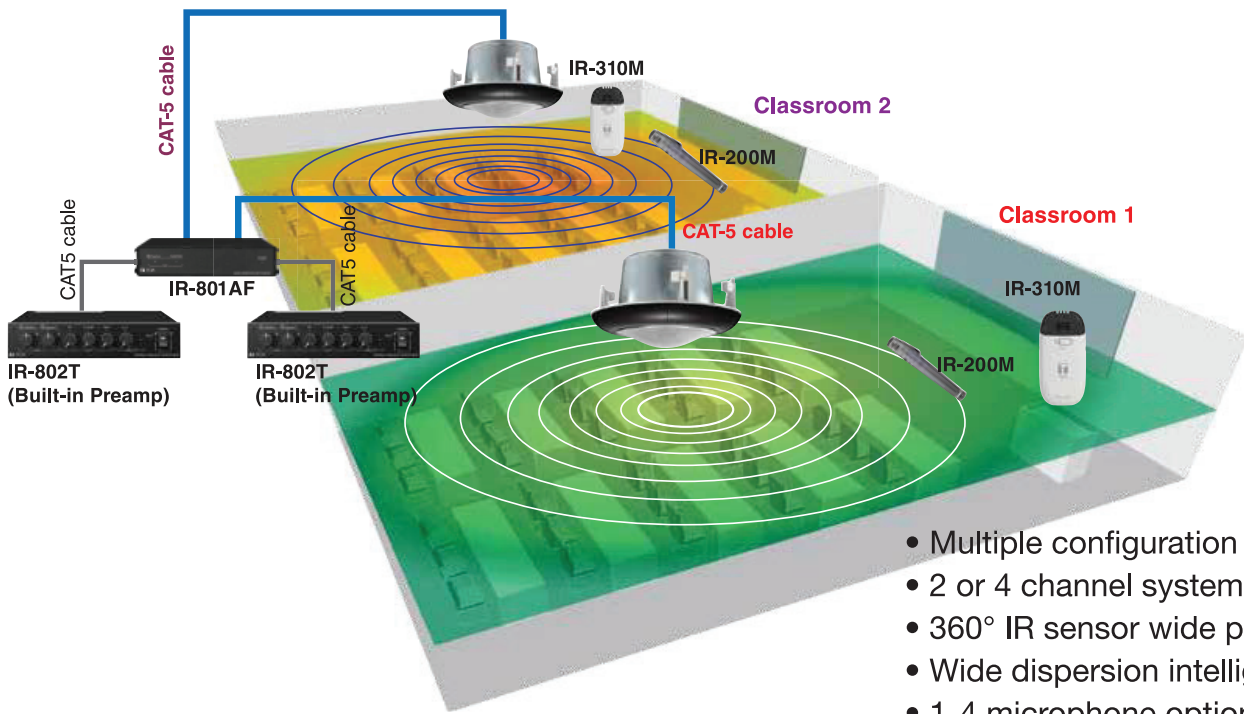

- Multiple configuration options
- 2 or 4 channel systems
- 360° IR sensor wide pickup
- Wide dispersion intelligible sound
- 1-4 microphone options

Infrared System Advantage

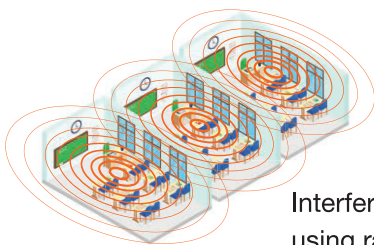

Interference occurs when using radio waves (UHF)

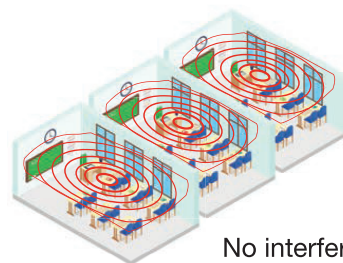

No interference occurs when using infrared

With walls providing a shield, infrared microphones can be used without the worry of interference from adjacent rooms. For example, setting microphones for use on the same channel makes it possible for a single microphone to be used in any room.

Campus Communication and Safety



Whether it be a single building or multi-campus education facility, the security requirements and communication needs remain the same. With schools designed in many shapes and sizes, employing the correct solution that delivers the campus wide features to communicate and secure their students is paramount. The system in place must offer the functionality necessary for administrators and teachers to feel confident in the school's security and ability to easily connect to other individuals or the entire school through public address.

Searching for the right mass notification system that can deliver intelligible sound throughout your entire school both indoor and outdoor can be a daunting task. TOA Canada understands the importance of student safety and the safety of the faculty. We carry a comprehensive product line that effectively manages building communication and security to ensure all occupants are safe at all times.

The key benefits when using the N-8000 series and VM-3000 series:

- Communication for regular day activities
- Ample coverage throughout facility
- Critical messaging during emergencies
- Single zone to multi zone, indoor or outdoor announcements
- Voice paging by microphone, intercom or phone system
- Digital signaling and messaging can be used
- Priority and muting capabilities



School Example

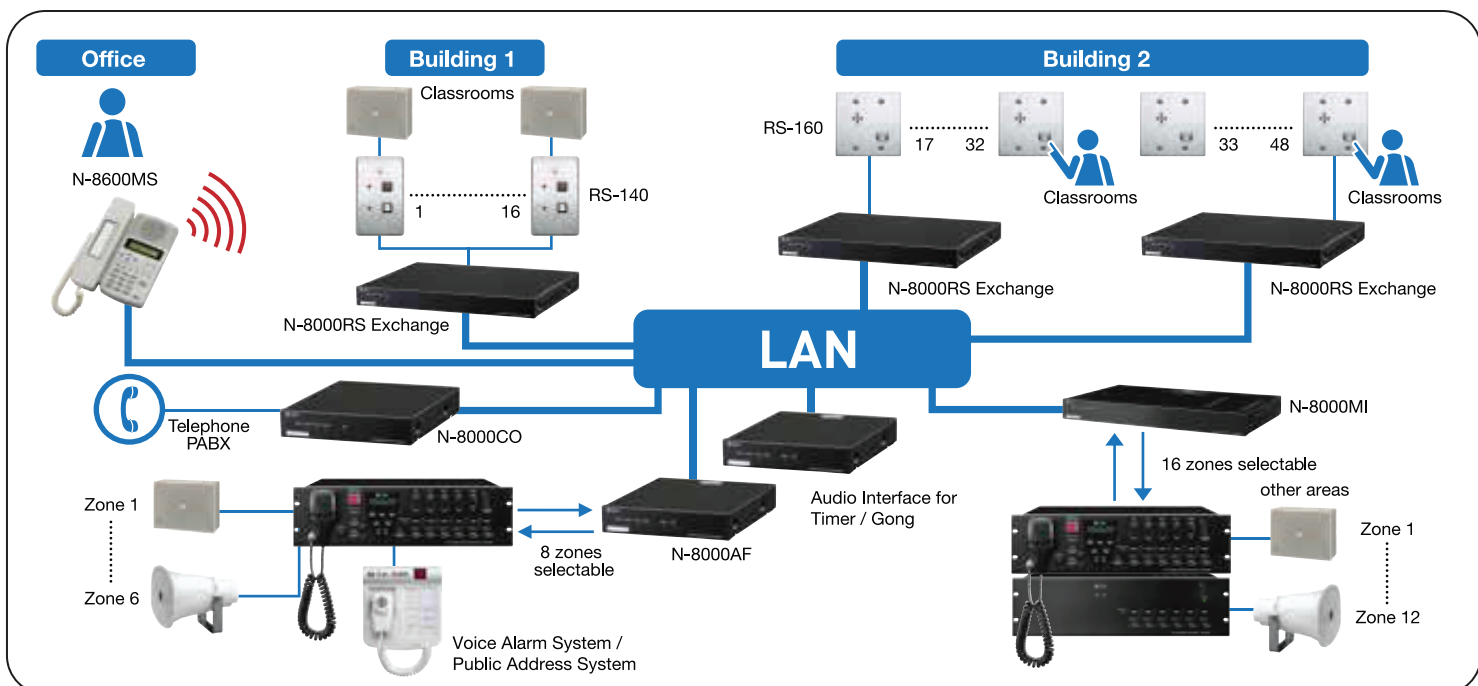

Daily Communication

Calling

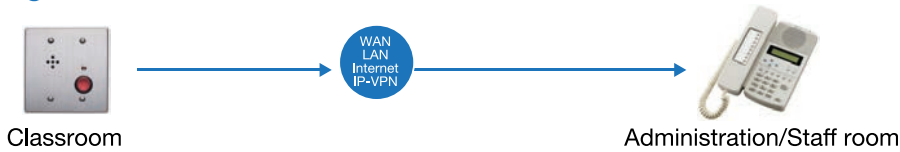

Paging Function Allows the master station as well as external input equipment to initiate paging by PA equipment or the speakers of individual stations. Operators can use the setup software to configure up to 192 paging zones to which paging calls can be made as desired.

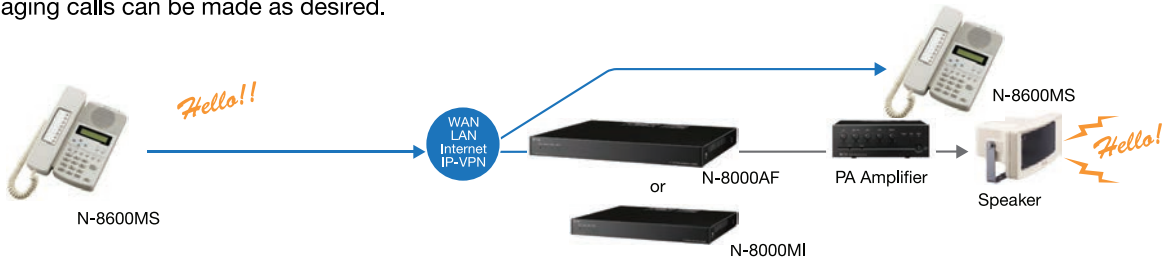

Time Signal Function Useful for time-based notifications and schedules, built-in chime tones or other audio signals from externally connected equipment can be broadcast to all stations and PA equipment according to a preset schedule.

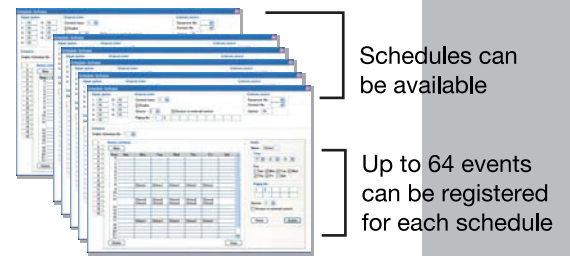

Security and Safety

Access Control SIP-based intercom stations offer high quality audio and video communication and a user friendly access control. View who is at the door, speak to them to gather information and decide to open the door or not.

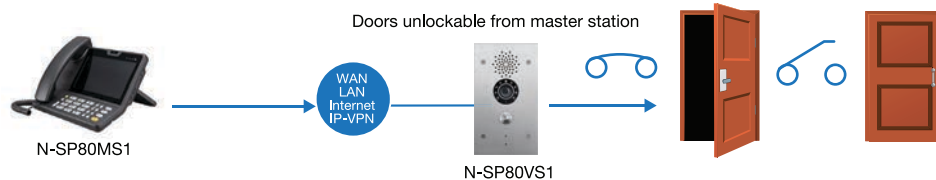

Audio Trigger Sets off an alarm if audio input to a pre-programmed station's microphone fulfils pre-set conditions (detection time or signal level). Examples include calls to the designated master station or contact output generated by another interface unit.

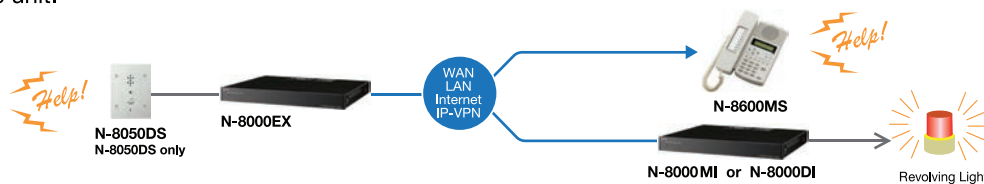

Scan Monitor Enables remote security monitoring by allowing the master station as well as analog telephones and external telephones to audio monitor two or more pre-programmed stations.



Conventional & IP Paging & Mass Notification

TOA Canada designs reliable and functional school solutions to execute daily school tasks while at the same time supplying the control and monitoring necessary to support a safe environment. Our IP and SIP based systems have the ability to integrate with other TOA and third party equipment, generating an all in one complete school offering.



Creating a secure environment with access control and emergency paging in all parts of the building is what we do. TOA Canada has earned the respect it receives from the educational market because of our experience and our product diversity. We supply responsive systems with all the bells and whistles in a cost-effective, high performance bundle.

School Solution

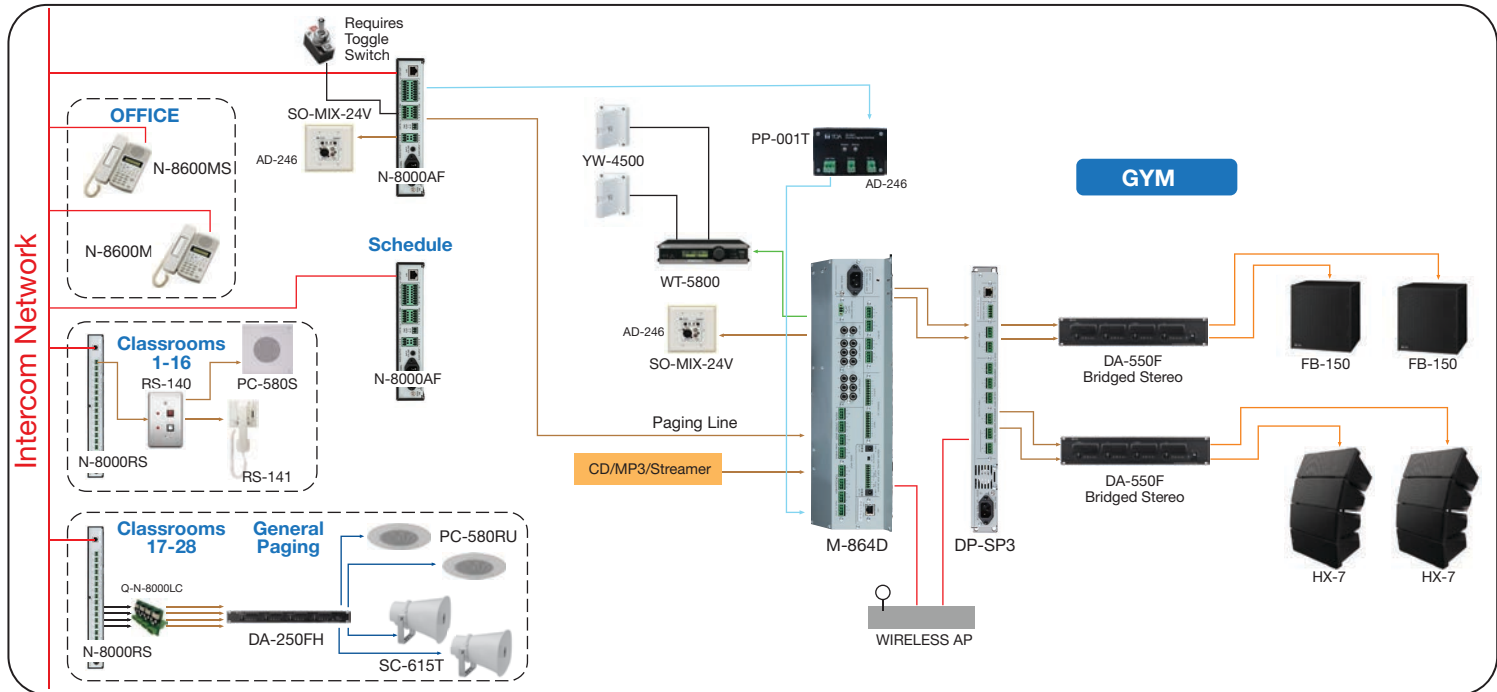

UL Certified Speakers

Choosing the correct speaker for your system is as important as the system itself. If the sound is not intelligible in all areas of the building, then the announcement can be missed by individuals and their safety put in danger.



PC-580RU & PC-580RVU
*HY-BB580 back can required for UL use



F-series ceiling speakers CU version



PE-604U & PE-304U
Pendant Speaker



BS-680U
Wall mount speaker



Outdoor or Indoor Speakers

*Also available in a UL version by special order. UL 1480 UEAY



*CS-64 Wide Range
Weatherproof Speaker



*CS-154 & *CS-304
Wide Range
Weatherproof Speaker



SC-630TU
Paging Horn Speaker

Network PA System

In a network PA system, equipment such as microphones and speakers can directly connect to the network. TOA's full solution permits access to create pre-recorded messages, live event trigger's and a host of other incredible options.

*Integrates with a VMS or operates as a standalone solution

COMING SOON

Operational Example - School Environment

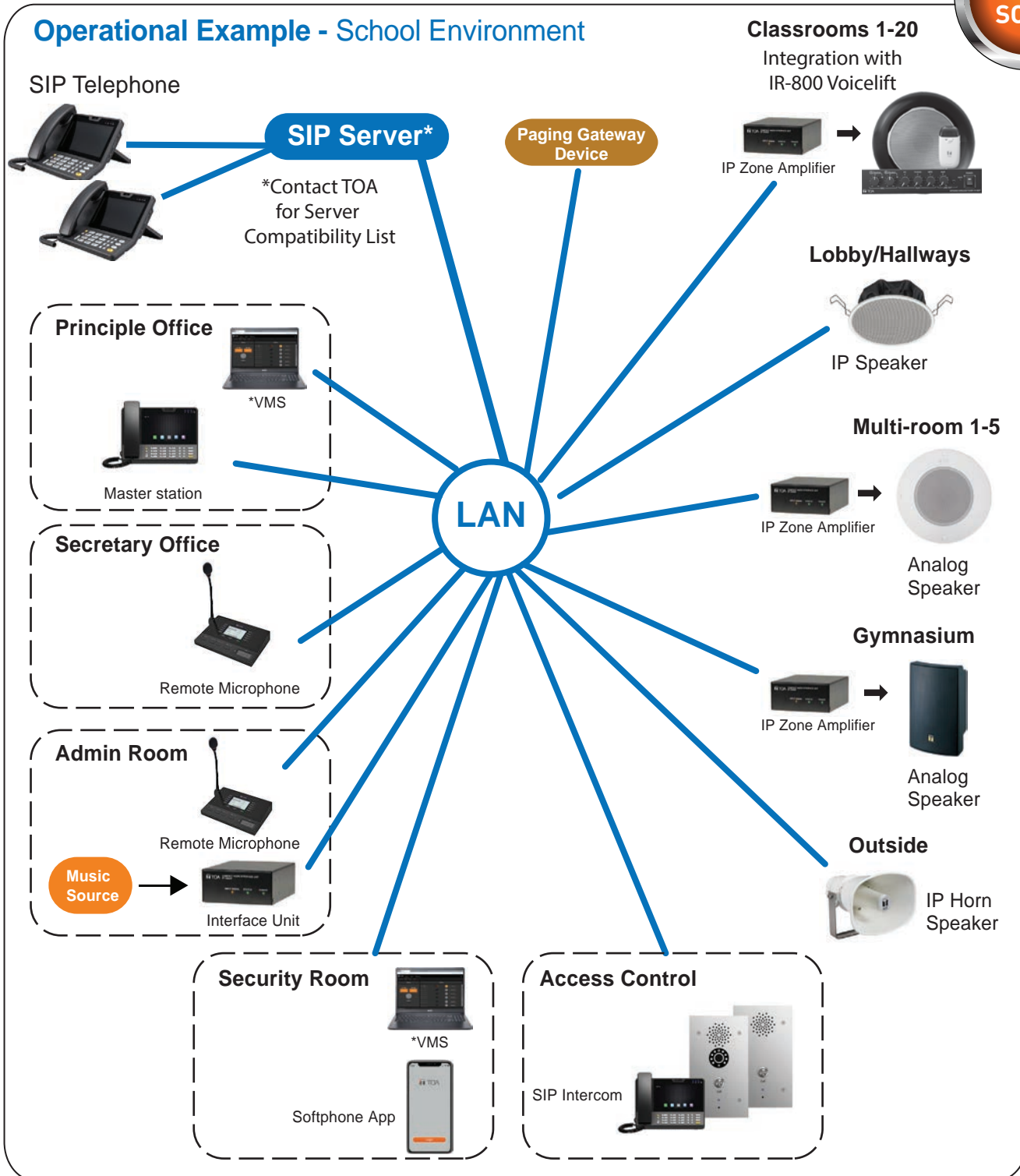

Key Features

- Integrates into existing facility network system (Serverless architecture)
- Flexible zone settings
- Broadcast Scheduling
- Trigger broadcast events
- Video Management System integration (ONVIF and HTTP)
- Several broadcasting options (from SIP phones and VMS software)

Gyms, Multi-Purpose Rooms Auditoriums & Cafeterias

Large gatherings of students for school events in gymnasiums and auditoriums require an audio system to deliver the message clearly. TOA products are designed to easily install as a new solution or integrate and enhance existing systems. Combined with our powerful amplifiers and outstanding digital mixers, our systems will offer cost-effective solutions for larger spaces.

Line Array Speakers Systems

This type of speaker permits various configurations to maximize sound transmission over long distances and minimize reflections. Their sound directivity makes them well suited for larger spaces like auditoriums and gymnasiums. The Impact-resistant construction is a great selling feature when installing the system in a gymnasium. These speakers are designed for minimum volume attenuation over distance to allow the high quality sound to be evenly dispersed at natural-sounding levels and do not need special equalization.



- Versatile mounting options
- Minimal reflective effects
- Uniform Sound Volume
- Clear Audio Output

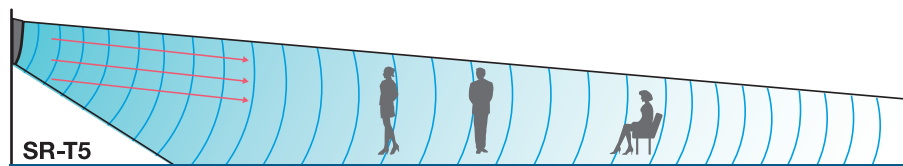
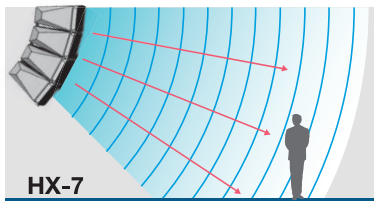

Power Amplifier

To ensure that the sound reaches your audience, use a TOA amplifier to power your audio system. The versatile features and outstanding value of our amplifiers along with the variety of amplifiers available, make an ideal addition to any school system.



DA-250F Power Amplifier

Digital Mixer

Ideal for use in acoustically challenging environments, TOA digital mixers incorporate an advanced measurement and processing algorithm to significantly improve speech intelligibility and sound quality. Other features include automatic suppression of feedback and Automatic Resonance Control function.



M-864D Digital Stereo Mixer



PP-001T Priority Paging Interface

UHF Microphones

Sound intelligibility is an important factor in student learning therefore educational institutions want a microphone that is reliable every time. TOA provides a full range of UHF and Digital wireless microphones optimized for both general and specific applications, all optimally compatible with accompanying tuner units and ancillary equipment.



UHF 5000 Series

Gymnasium System Solution

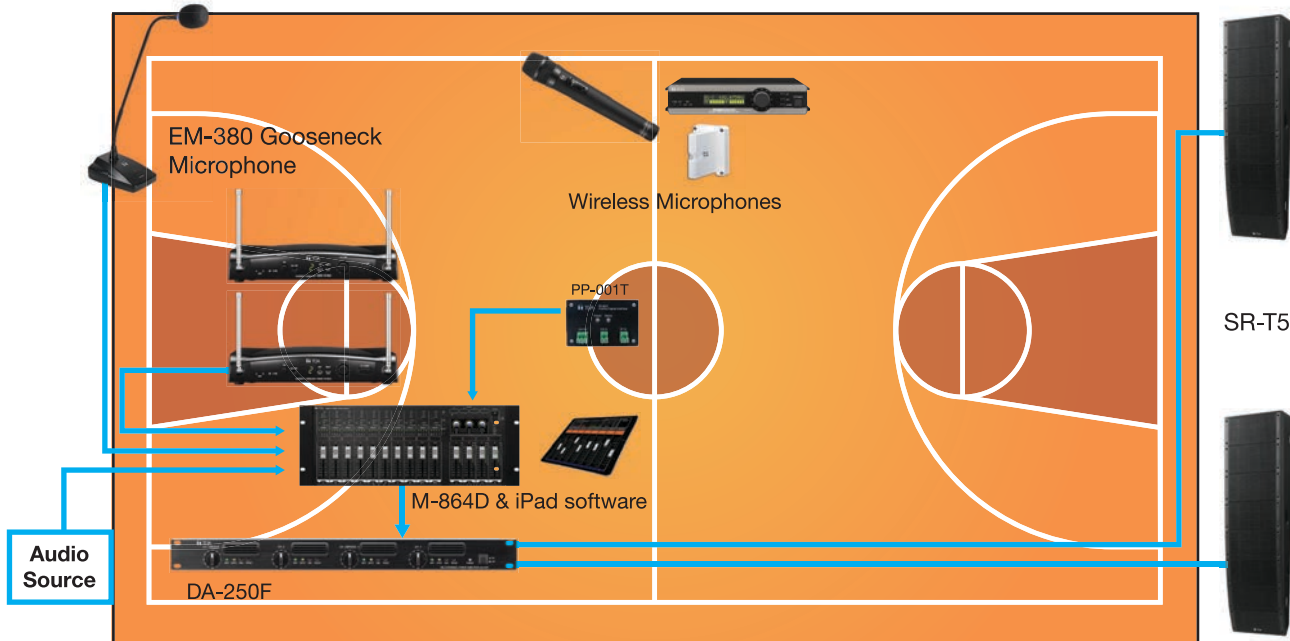

Gyms, Multi-Purpose Rooms Auditoriums & Cafeterias

Auditoriums are an important space for students at all school levels. It offers a place to step away for a while from the everyday grind of classroom education. Time spent in the auditorium can run minutes in case of a school assembly to a couple of hours for a school event or performance. To keep the audience attentive, it's important to create a sound system that distributes clear and intelligible sound.

Whether it be a large or small auditorium, TOA Canada works with individual schools to design a flexible sound system that suits the various performances displayed on the stage. It could be a speech, students singing or musical instruments, but regardless of the content, the sound field broadcast must reach all corners of the room.

Another feature that requires consideration, to ensure the safety of all persons in the room, is the integration of the sound system to the school's PA set-up. Schools are always reviewing safety plans to ensure everyone's ability to exit the building in case of emergency. Installing a quality sound system for the auditorium that is incorporated with the PA system will ensure that the auditorium is a safe place to be.

School Auditorium System Solution

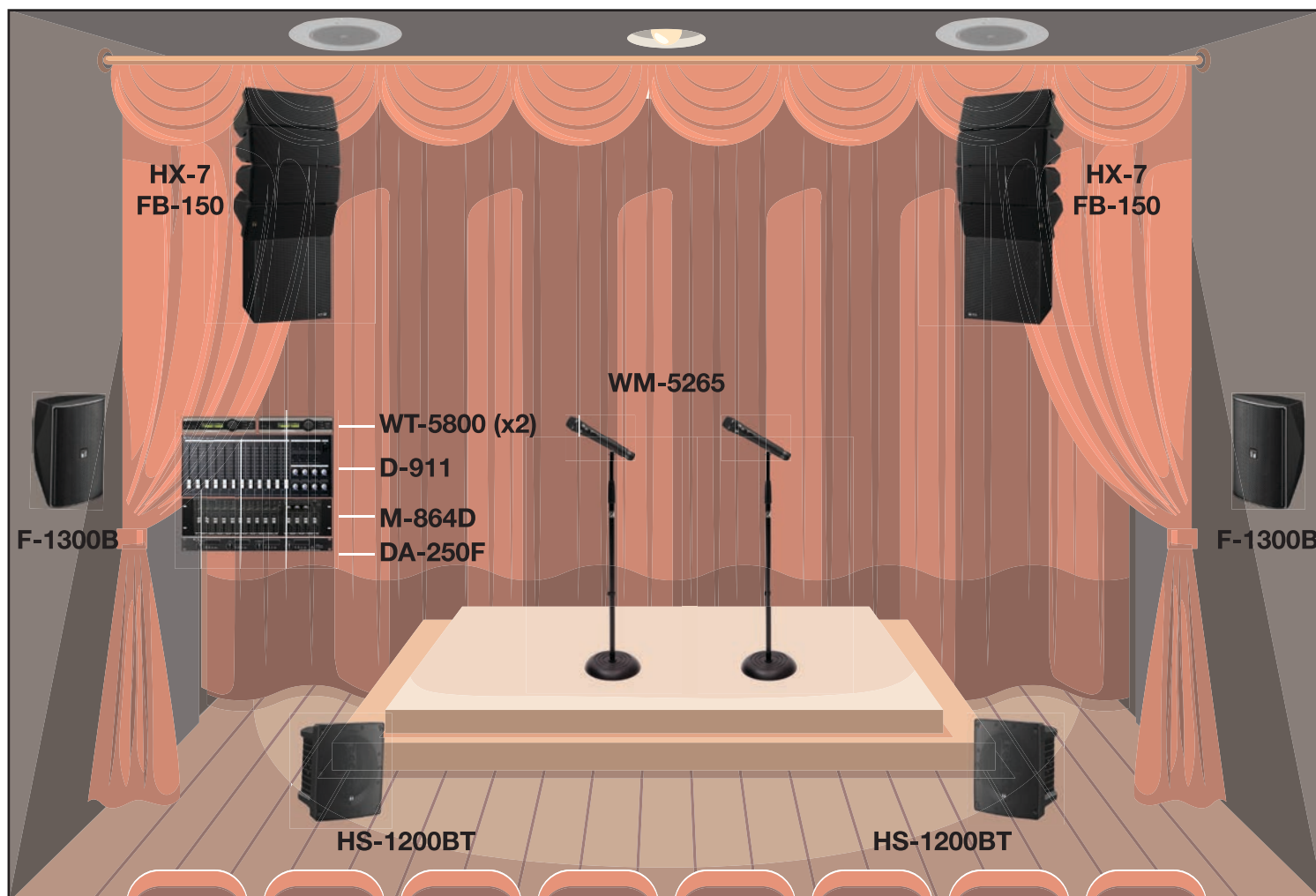

School Cafeteria System Solution

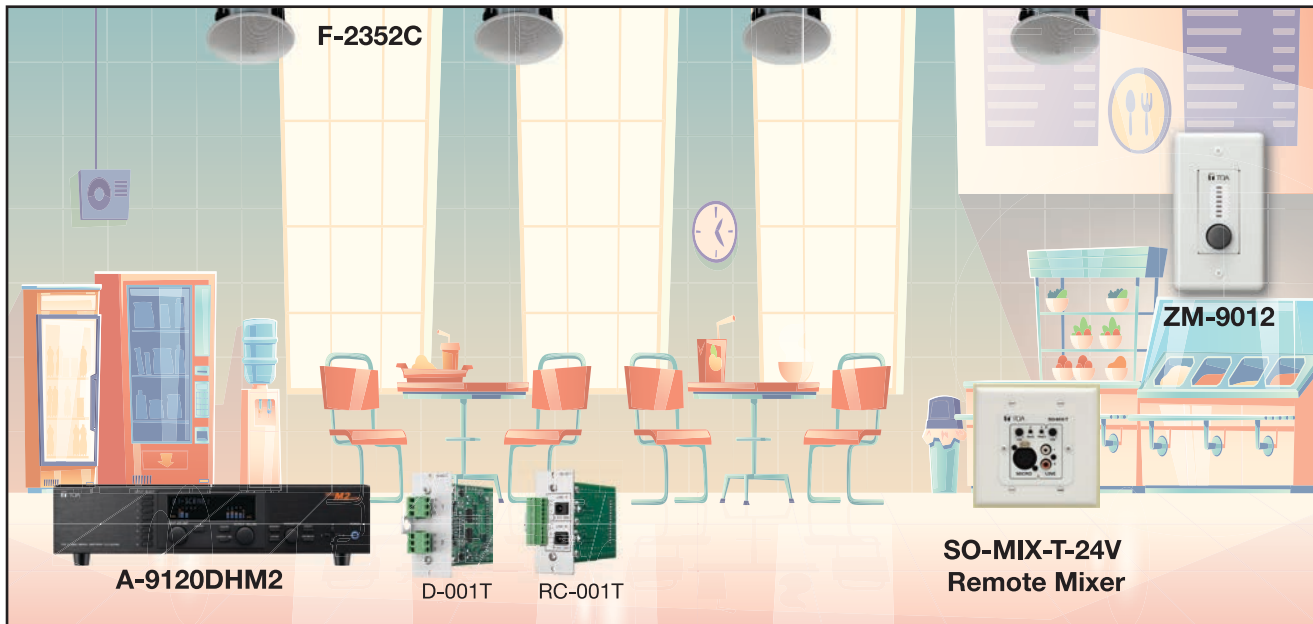

Cafeterias have always come alive with students during the lunch hour but now other gatherings are taking place in these spaces as schools sometimes struggle to find areas for student events or after school clubs. Either way, these rooms require attention when setting up a PA solution that can integrate with the rest of the school system. TOA also builds systems with the ability to play background music with straightforward wall control units.

Megaphones Best-in-class

TOA offers an extensive range of portable power megaphones that provide optimal reinforcement for various applications in different environments such as schools, government organization facilities, factories and many others. All models incorporate anti-bacterial treatment to cope with multi-user environments. Featuring compact and stylish designs with powerful outputs, TOA megaphones also include splash-resistant types as well as high-performance shoulder types that provide a separate auxiliary input and even wireless microphone capability (ER-2930W). Other features such as siren (S) and whistle (W) are available on some models.



Megaphone with Siren



Megaphone with Whistle



Personal PA System



Megaphone

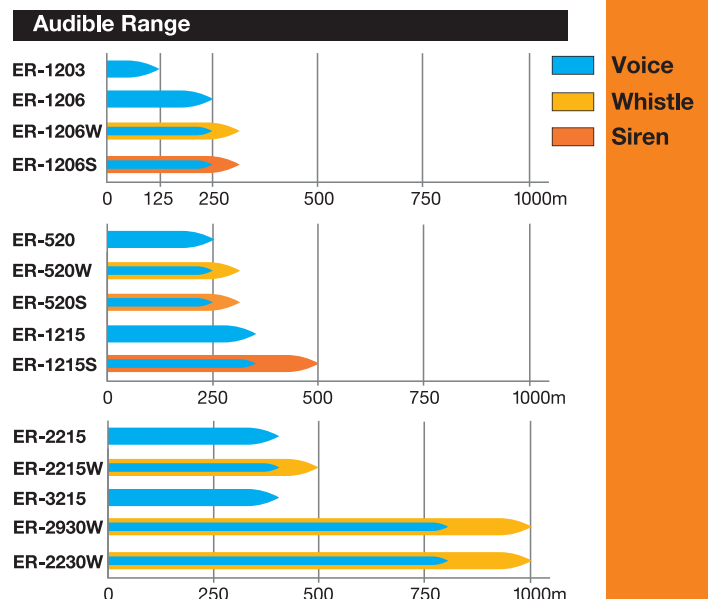

Outdoor Audio



Regardless of the size of the school's outdoor property, creating an intelligible, acoustically pleasing area will ensure announcements are heard and emergency guidance acted on. Choosing the correct speakers that can adapt to each unique school outdoor space can be formidable. At TOA our outdoor speakers distribute intelligible sound for clear listening, and they have the ability to have the positional direction adjusted to ensure excellent coverage.

SC Horn Series

SC-615T



SC-630



SC-651



CS Horn Series

CS-64



CS-154



CS-304



Coast to coast to coast  and all parts in between

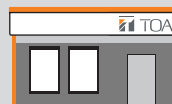

Canadian
Headquarters



Canadian
Technical
Support



Canadian Warehouse
& Expedited Shipping

Additional School AV Options.

Wireless Options



Handheld
Wireless Kit



Lavalier
Wireless Kit



Individual
Microphones



Battery Charger



Antenna Distributor



Assistive
Listening Device



Headworn
Microphone



Single Ear
Microphone



Lavalier
Microphone

SO-MIX-T-24V Remote Mixer



The ideal choice where a user-accessible mixer must control the volume of multiple sources. This remote mixer allows the main system components to be centralized at a single location, while maintaining local control over its inputs.

AM-CF1 Integrated Audio Collaboration System (Black or White)



This audio system designed for conference rooms, can also be incorporated into school meeting rooms for enhanced voice conversation. With remote learning now commonplace, lessons filtering from school locations need to ensure that teachers can clearly be heard while reducing the stress on their voices. On the other side, students at home require that what they are listening to intelligible and without distortion. Whether it be a class lesson or a management zoom meeting, the AM-CF1 is an ideal addition to every school meeting room and even larger school boardrooms.

Warranty



TOA Products are manufactured under strict control and shipped in perfect operating condition to provide years of trouble-free service. All TOA Products are warranted to be free from defects in material and workmanship.



We supply sound, not equipment.



TOA Canada Corporation
www.TOAcanda.com
sales@toacanda.com
Specifications are subject to change without notice