

DIGITAL PROCESSOR

DP-0206

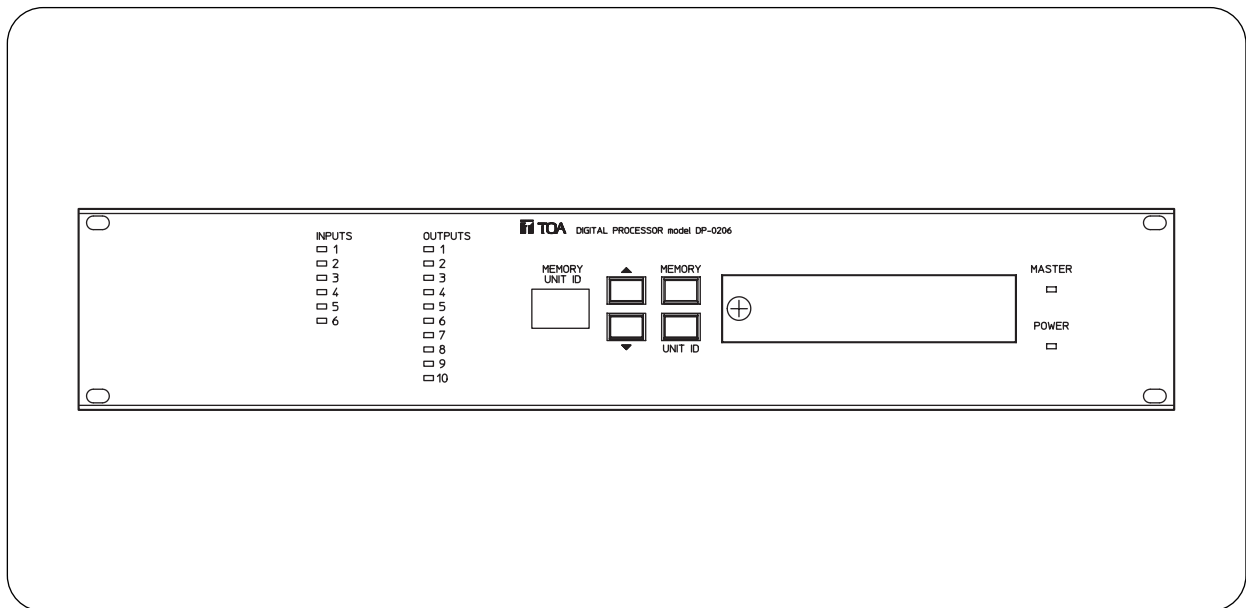

Please follow the instructions in this manual to obtain the optimum results from this unit. We also recommend that you keep this manual handy for future reference.

Important

When the YA-304 power cord is attached to the DP-0206 unit, the power voltage must be under 125 V. If the power voltage exceeds 125 V, prepare a different power cord. When the power cord other than the YA-304 is attached, the unit can be used in areas where the power voltage is 230 V.

TABLE OF CONTENTS

1. SAFETY PRECAUTIONS	3
2. GENERAL DESCRIPTION	5
3. FEATURES	5
4. HANDLING PRECAUTIONS	5
5. ABOUT THE SIGNAL PROCESSING FUNCTION	5
6. NOMENCLATURE AND FUNCTIONS	
Front	6
Inside of the Security Cover	7
Rear	7
Analog Input Module DQ-A01 (Optional product)	8
Analog Output Module DQ-A02 (Optional product)	8
Remote Control Module DQ-C01 (Optional product)	8
7. INSTALLATION	
7.1. Optional Module Installation	
7.1.1. Analog input and output module installation	9
7.1.2. Remote control module installation	11
7.2. Input/Output and Control Cable Connections	12
7.3. Connections between Units	14
7.4. Input/Output Configuration Settings and Confirmation	
7.4.1. Input/Output configuration settings	15
7.4.2. Input/Output configuration confirmation	15
7.4.3. Default signal flow	16
7.5. Unit ID Number Setting and Confirmation	
7.5.1. Unit ID Number setting	16
7.5.2. Changing the Unit ID Number	17
7.5.3. Unit ID Number confirmation	17
7.6. PC Connections	
7.6.1. RS-232C connections	18
7.6.2. RS-485 connections	19
7.7. Pattern Memory Recall	20
8. APPENDIX	
8.1. System Lock Function	21
8.2. Propagation Delay	21
8.3. Display Conditions of the Memory/Unit ID Number Display	21
8.4. Error Indications	22
8.5. Initialization	22
8.6. Rack Mounting	22
8.7. RS-232C/RS-485 Converter	22
8.8. Junction Connectors for Input/Output Connectors	22
8.9. RS-485 Transmission Cable	22
8.10. Changing the RS-485 Communication Speed	23
8.11. Recalling Pattern Memory Using the Memory Selector	
8.11.1. Using the unit's RS-232C communication port	24
8.11.2. Using the Remote Control Module	27
8.12. Controlling the Remote Control Module's Terminals	
8.12.1. Pattern memory recall	28
8.12.2. Output volume adjustment	30
8.12.3. Output muting	32
8.13. Firmware Update	
8.13.1. Confirmation of connections	33
8.13.2. Update program activation	34
8.13.3. Update	34
8.13.4. Setting restoration	38
8.14. Internal Memory Programming Precautions	38
8.15. Memory/Unit ID Number Display Indication at Activation	39
8.16. Connection Example	40
9. BLOCK DIAGRAM	41
10. SPECIFICATIONS	
DP-0206	42
DQ-A01, DQ-A02	43
DQ-C01	44

1. SAFETY PRECAUTIONS

- Be sure to read the instructions in this section carefully before use.
- Make sure to observe the instructions in this manual as the conventions of safety symbols and messages regarded as very important precautions are included.
- We also recommend you keep this instruction manual handy for future reference.

Safety Symbol and Message Conventions

Safety symbols and messages described below are used in this manual to prevent bodily injury and property damage which could result from mishandling. Before operating your product, read this manual first and understand the safety symbols and messages so you are thoroughly aware of the potential safety hazards.



WARNING

Indicates a potentially hazardous situation which, if mishandled, could result in death or serious personal injury.

When Installing the Unit

- Do not expose the unit to rain or an environment where it may be splashed by water or other liquids, as doing so may result in fire or electric shock.
- Use the unit only with the voltage specified on the unit. Using a voltage higher than that which is specified may result in fire or electric shock.
- Do not cut, kink, otherwise damage nor modify the power supply cord. In addition, avoid using the power cord in close proximity to heaters, and never place heavy objects -- including the unit itself -- on the power cord, as doing so may result in fire or electric shock.

When the Unit is in Use

- Should you detect smoke or a strange smell coming from the unit during use, immediately disconnect the power supply plug from the AC outlet and contact your nearest TOA dealer. Make no further attempt to operate the unit in this condition as this may cause fire or electric shock.
- Do not place cups, bowls, or other containers of liquid or metallic objects on top of the unit. If they accidentally spill into the unit, this may cause a fire or electric shock.



CAUTION

Indicates a potentially hazardous situation which, if mishandled, could result in moderate or minor personal injury, and/or property damage.

When Installing the Unit

- Never plug in nor remove the power supply plug with wet hands, as doing so may cause electric shock.
- When unplugging the power supply cord, be sure to grasp the power supply plug; never pull on the cord itself. Operating the unit with a damaged power supply cord may cause a fire or electric shock.
- Avoid installing the unit in humid or dusty locations, in locations exposed to the direct sunlight, near the heaters, or in locations generating sooty smoke or steam as doing otherwise may result in fire or electric shock.
- Do not block any ventilation openings. Install in accordance with the manufacturer's instructions.
- Do not install near any heat sources such as radiators, heat registers, stoves, or other apparatus (including amplifiers) that produce heat.
- Do not defeat the safety purpose of the polarized or grounding-type plug. A polarized plug has two blades with one wider than the other. A grounding type plug has two blades and a third grounding prong. The wide blade or the third prong are provided for your safety. If the provided plug does not fit into your outlet, consult an electrician for replacement of the obsolete outlet.
- Only use attachments/accessories specified by the manufacturer.

When the Unit is in Use

- Unplug the power supply plug from the AC outlet for safety purposes when cleaning or leaving the unit unused for 10 days or more. A fire or electric shock may result.
- Use only with the cart, stand, tripod, bracket, or table specified by the manufacturer, or sold with the apparatus. When a cart is used, use caution when moving the cart/apparatus combination to avoid injury from tip-over.



- Unplug this apparatus during lightning storms or when unused for long periods of time.
- Refer all servicing to qualified service personnel. Servicing is required when the apparatus has been damaged in any way, such as power-supply cord or plug is damaged, liquid has been spilled or objects have fallen into the apparatus, the apparatus has been exposed to rain or moisture, does not operate normally, or has been dropped.

WARNING (FOR U.S.A. only)

This equipment generates, uses, and can radiate radio frequency energy and if not installed and used in accordance with the instructions manual, may cause interference to radio communications. It has been tested and found to comply with the limits for a Class A computing device pursuant to Subject J of Part 15 of FCC Rules, which are designed to provide reasonable protection such interference when operated in a commercial environment.

Operation of this equipment in a residential area is likely to cause interference in which case the user at his own expense will be required to take whatever measures may be required to correct the interference.



CAUTION

**RISK OF ELECTRIC SHOCK
DO NOT OPEN**



TO REDUCE THE RISK OF ELECTRICAL SHOCK, DO NOT REMOVE COVER. NO USER SERVICEABLE PARTS INSIDE. REFER SERVICING TO QUALIFIED SERVICE PERSONNEL.



The lightning flash with arrowhead within a triangle is intended to tell the user that parts inside the product are a risk of electric shock to persons.



The exclamation point within a triangle is intended to tell the user that important operating and servicing instructions are in the papers with the appliance.

CAUTION

These servicing instructions are for use by qualified personnel only.

To avoid electric shock, do not perform any servicing other than that contained in the operating instructions unless you are qualified to do so.

Refer all servicing to qualified service personnel.

2. GENERAL DESCRIPTION

The TOA DP-0206 is a 2-rack unit size Digital Processor provided with signal processing function necessary for sound systems. The settings of each function are performed from a PC using dedicated software, and can be stored in the unit's memory. The stored settings can be recalled from the unit without connecting the PC.

3. FEATURES

- Digital signal processing system permits highly-accurate acoustic parameter settings.
- Signal flow and signal processing functions can be freely set from a PC, and the settings can be saved in a file.
- Because 16 memories are built inside, stored data can be easily recalled without connecting a PC after setting completion.
- Up to 30 DP-0206 units can be simultaneously controlled using the RS-485 port.
- The system-lock function prevents trouble resulting from misoperation.
- Wide power voltage range of 100 – 240 V AC.
- Inputs and outputs can be expanded to up to a total of 12 channels with the addition of an optional DQ-A01 Analog Input Module, and a DQ-A02 Analog Output Module.
- Pattern memory recall, output volume adjustment, and output muting can be controlled from external equipment with the addition of an optional DQ-C01 Remote Control Module.

4. HANDLING PRECAUTIONS

- Use the unit in locations where the temperature fluctuates in the range of 0 – 40°C, and the humidity is under 90% (no dew condensation must be formed).
- To avoid the unit's failure, do not give the unit a strong shock or vibration.
- To clean, wipe the unit with a soft cloth. Never use benzine, thinner or chemically-processed towel because the unit's finish may be adversely affected.
- The unit has no direct parameter setting function. A PC and dedicated software are required for setting parameters.
- Make sure that the power is switched on only after all connections are completed.

5. ABOUT THE SIGNAL PROCESSING FUNCTION

The DP-0206 is a digital signal processor. Various signal processing functions and value settings are dependent on PC software. For details of the signal processing functions, refer to the separate software instruction manual.

6. NOMENCLATURE AND FUNCTIONS

[Front]

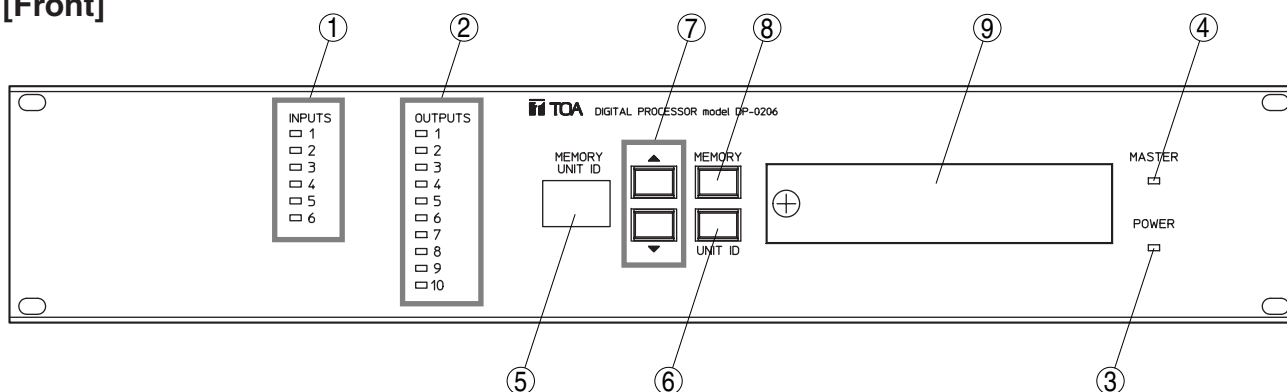

1. Input Level Indicator [INPUTS 1 – 6]

Indicates the input level and status of each input channel.

- Lights red when the input level exceeds 18 dB*.
- Lights green when the input level is within the range of –48 to 18 dB*.
- Is extinguished when the input level lowers –48 dB*.
- Lights orange or flashes red when an optional module is mounted in the wrong position.

* 0 dB = 0.775 V

Notes

- When the Input Level indicator lights red, this indicates that the input signal level is very high. In such cases, adjust the level of connected equipment so that the indicator lights green.
- When the indicator lights orange or flashes red, reinstall the module correctly. (Refer to p. 15 "Input/Output Configuration Settings and Confirmation.")

2. Output Level Indicator [OUTPUTS 1 – 10]

Indicates the output level and status of each output channel.

- Lights red when the output level exceeds 18 dB*.
- Lights green when the output level is within the range of –48 to 18 dB*.
- Is extinguished when the output level lowers –48 dB*.
- Lights orange or flashes red when an optional module is mounted in the wrong position.
- When the Output Level indicator flashes orange, this indicates that the output is being muted.

* 0 dB = 0.775 V

Notes

- When the indicator lights red, this indicates that the signal level is very high. In such cases, adjust the unit's output level so that the indicator lights green.
- When the indicator lights orange or flashes red, reinstall the module correctly. (Refer to p. 15 "Input/Output Configuration Settings and Confirmation.")

3. Power Indicator [POWER]

Lights when the power is switched on.

Note: The DP-0206 unit is not equipped with a power switch. Connect the power cord to a wall AC outlet to turn on the power.

4. Master Indicator [MASTER]

Lights when the unit is used singly. When two or more units are connected, the indicator only on the unit set for Unit ID No. 1 (master unit) lights. The unit assigned ID No. 1 functions as the master unit to recall the pattern memory. The Master indicator flashes when a PC is connected. (Refer to p. 16 "Unit ID Number Settings and Confirmation.")

5. Memory/Unit ID Number Display [MEMORY/UNIT ID]

Displays either the Memory or Unit ID number. To distinguish between both numbers, the Memory number display remains lit, while the ID number display flashes. Normally, the selected Memory number is displayed. (Refer to p. 21 "Display Conditions of the Memory/Unit ID Number Display.")

6. Unit ID Number Display Key [UNIT ID]

Used to show the Unit ID number on the Memory/Unit ID Number display. When multiple DP-0206 units are connected, pressing the ID Number Display key on any one of such connected units shows the corresponding ID number on each unit's display.

7. Memory/Unit ID Number Selector Key [▲▼]

Increases or decreases the memory or Unit ID number. The selected number is displayed on the Memory/Unit ID Number display.

8. Memory Recall Key [MEMORY]

Calls up the pattern memory selected with the Memory/Unit ID Number Selector key.

9. Security Cover

For details, refer to p. 7 "Inside of the Security Cover."

[Inside of the Security Cover]

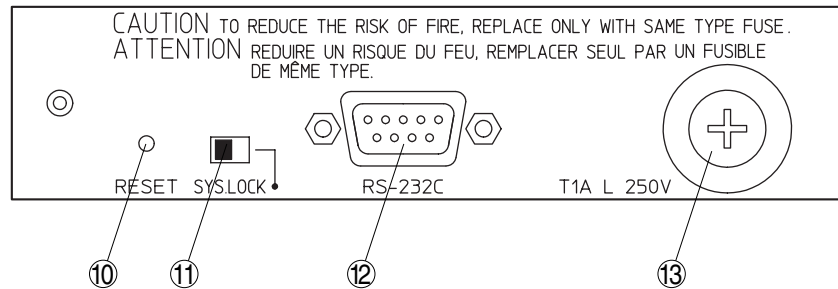

10. Reset Key [RESET]

Returns the unit to the initial setting at the time when the power has been switched on.

Notes

- This switch does not erase internal settings.
- Using a pen or other pointed tool, press and release the key.

11. System Lock Switch [SYS LOCK]

Shifting this switch to the right disables specific front-accessed functions. (Refer to p. 21 "System Lock Function.")

12. RS-232C Communications Port [RS-232C]

This port is a 9-pin (female) D-sub connector for RS-232C communications and is connected in parallel with the rear panel-mounted D-sub connector (female) for RS-232C. (Refer to p. 18 "Connections by means of RS-232C.")

13. Fuse Holder

Be sure to use the specified type of fuse (T1A L 250 V).

[Rear]

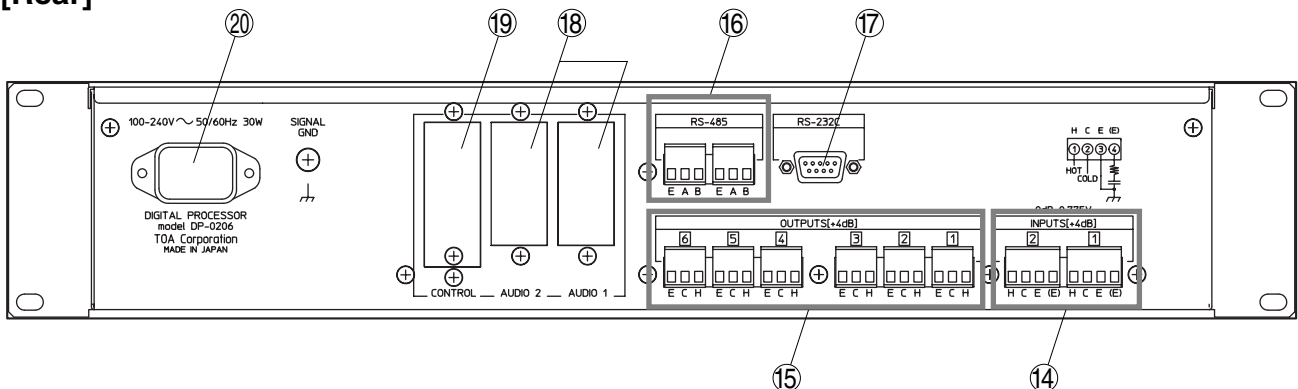

14. Input Connector [INPUTS (+4 dB) 1 – 2]

Electronically-balanced input employing a terminal block type 4-pole connector.

15. Output Connector [OUTPUTS (+4 dB) 1 – 6]

Electronically-balanced output employing a terminal block type 3-pole connector.

16. RS-485 Communications Port [RS-485]

Terminal block type 3-pole connector for RS-485 communications. When simultaneously controlling two or more DP-0206 units, connect this port to the other unit. When connecting a PC to this port, a conversion adapter is required between the unit and the PC. (Refer to p. 19 "Connections by means of RS-485.")

17. RS-232C Communications Port [RS-232C]

This port is a 9-pin D-sub connector (female) for RS-232C communications and is connected in

parallel with the front panel-mounted (female) D-sub connector for RS-232C.

18. Optional Module Slot [AUDIO 1 – 2]

Used to mount an optional DQ-A01 Analog Input Module or an optional DQ-A02 Analog Output Module for input and output expansion. (Refer to p. 9 "Optional Module Installation.")

19. Optional Module Slot [CONTROL]

Used to mount an optional DQ-C01 Remote Control Module for remote control of pattern memory recall, output volume adjustment, and output signal muting from external equipment. (Refer to p. 11 "Remote control module installation.")

20. Power Inlet

Connect the supplied power cord to this inlet.

• **Analog Input Module DQ-A01 (Optional product)**

Expands the inputs by 2 channels.

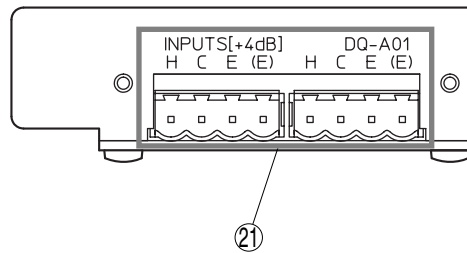

21. Input Connector [INPUTS (+4 dB) 3 – 4 or 5 – 6]

Electronically-balanced input with a terminal block type 4-pole connector.

• **Analog Output Module DQ-A02 (Optional product)**

Expands the outputs by 2 channels.

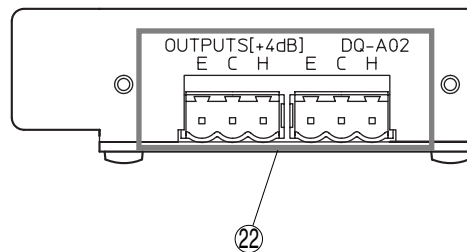

22. Output Connector [OUTPUT (+4 dB) 7 – 8 or 9 – 10]

Electronically-balanced output with a terminal block type 3-pole connector.

• **Remote Control Module DQ-C01 (Optional product)**

Permits pattern memory recall, output volume adjustment, and output signal muting to be controlled from external equipment.

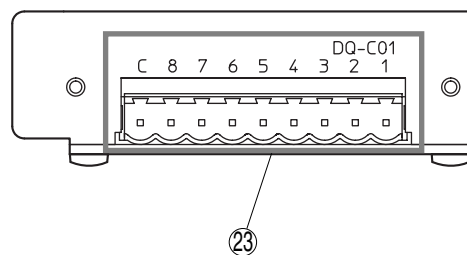

23. Control Connector

Shorting the C (common) terminal with one of terminals No. 1 – No. 8 permits remote control. Function settings are performed by means of dedicated software. For details, refer to the separate software instruction manual.

7. INSTALLATION

Follow the procedures below to install the unit:

- Step 1.** Installation of option modules (Refer to p. 9.)
- Step 2.** Input/output and control cable connections (Refer to p. 12.)
- Step 3.** Connections between units (Refer to p. 13.)
- Step 4.** Input/output configuration setting (Refer to p. 15 "Input/Output Configuration Settings and Confirmation.")
- Step 5.** Unit ID number setting (Refer to p. 16 "Unit ID Number Settings and Confirmation.")
- Step 6.** PC connection (Refer to p. 18.)
- Step 7.** Parameter settings by means of software (Refer to the separate software instruction manual.)
- Step 8.** Pattern memory recall (Refer to p. 20.)

Tip: Refer to the separate software instruction manual for details on the software installation in the PC and the unit's parameter settings.

7.1. Optional Module Installation

CAUTION

These servicing instructions are for use by qualified personnel only. To avoid electric shock, do not perform any servicing other than that contained in the operating instructions unless you are qualified to do so. Refer all servicing to qualified service personnel.

Input/output expansion or external equipment control can be achieved with the addition of an optional DQ-A01 Analog Input Module, DQ-A02 Analog Output Module or DQ-C01 Remote Control Module.

Handling precautions

- Make sure that the power cord is removed from the AC outlet during installation.
- To avoid failures due to static electricity, do not touch the parts or terminals on the circuit board of both the unit and module.
- Ensure that the module is installed in the correct position.

7.1.1. Analog input and output module installation

Inputs and outputs can be expanded with the addition of the optional DQ-A01 Analog Input module and optional DQ-A02 Analog Output module. Because the module installation position differs depending on the input and output configuration, ensure that the correct module slot is selected by checking the table below:

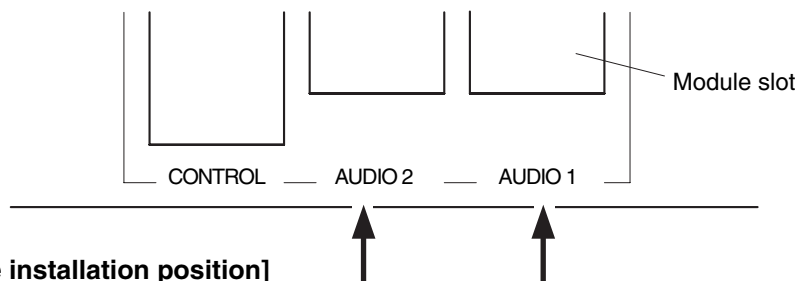

[I/O configuration vs. Module installation position]

I/O Configuration	AUDIO 2	AUDIO 1
2-IN/6-OUT	No module	No module
2-IN/8-OUT	DQ-A02	No module
2-IN/10-OUT	DQ-A02	DQ-A02
4-IN/6-OUT	No module	DQ-A01
4-IN/8-OUT	DQ-A02	DQ-A01
6-IN/6-OUT	DQ-A01	DQ-A01

Step 1. Remove the power cord from the DP-0206.

Step 2. Remove 5 screws to detach the top panel.

Step 3. Detach the cover of the module slot to be used (AUDIO 1 or AUDIO 2) depending on the input/output configuration by removing two screws.

Step 4. Install the optional module in the corresponding slot. (Refer to p. 9.) To achieve this, fully insert the module into the unit's connector (CN1 or CN2), then fix the module front to the unit's rear panel using screws.

Caution: Take care not to touch the parts or terminals on the circuit board of both the unit and module to avoid failures due to static electricity.

Step 5. Affix the seal (attached to the DQ-A01 and DQ-A02) showing the input and output numbers of the mounted module to the unit.

Step 6. Replace the top panel.

Note: The illustration is an example of the unit with 4-IN/8-OUT configuration.

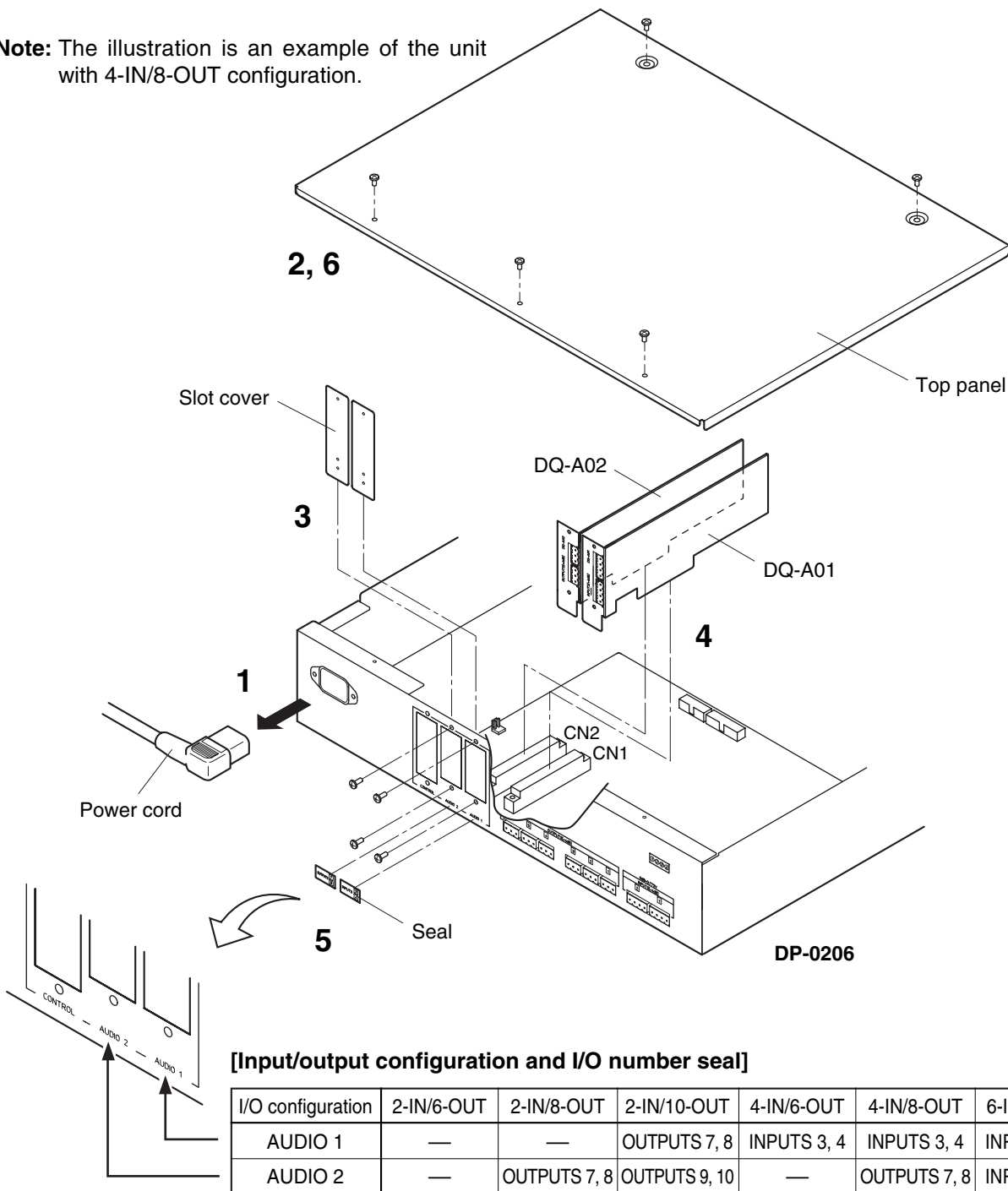

7.1.2. Remote control module installation

External equipment control can be performed with the addition of an optional DQ-C01 Remote Control Module.

Step 1. Remove the power cord from the DP-0206.

Step 2. Remove 5 screws to detach the top panel.

Step 3. Detach the module slot (CONTROL) cover by removing two screws.

Step 4. Install the Remote Control Module, then fix the module front to the unit's rear panel using screws.

Caution: Take care not to touch the parts or terminals on the circuit board of both the unit and module to avoid failures due to static electricity.

Step 5. Connect the module's power cable to Connector CN20, and its control cable to Connector CN15.

Step 6. Replace the top panel.

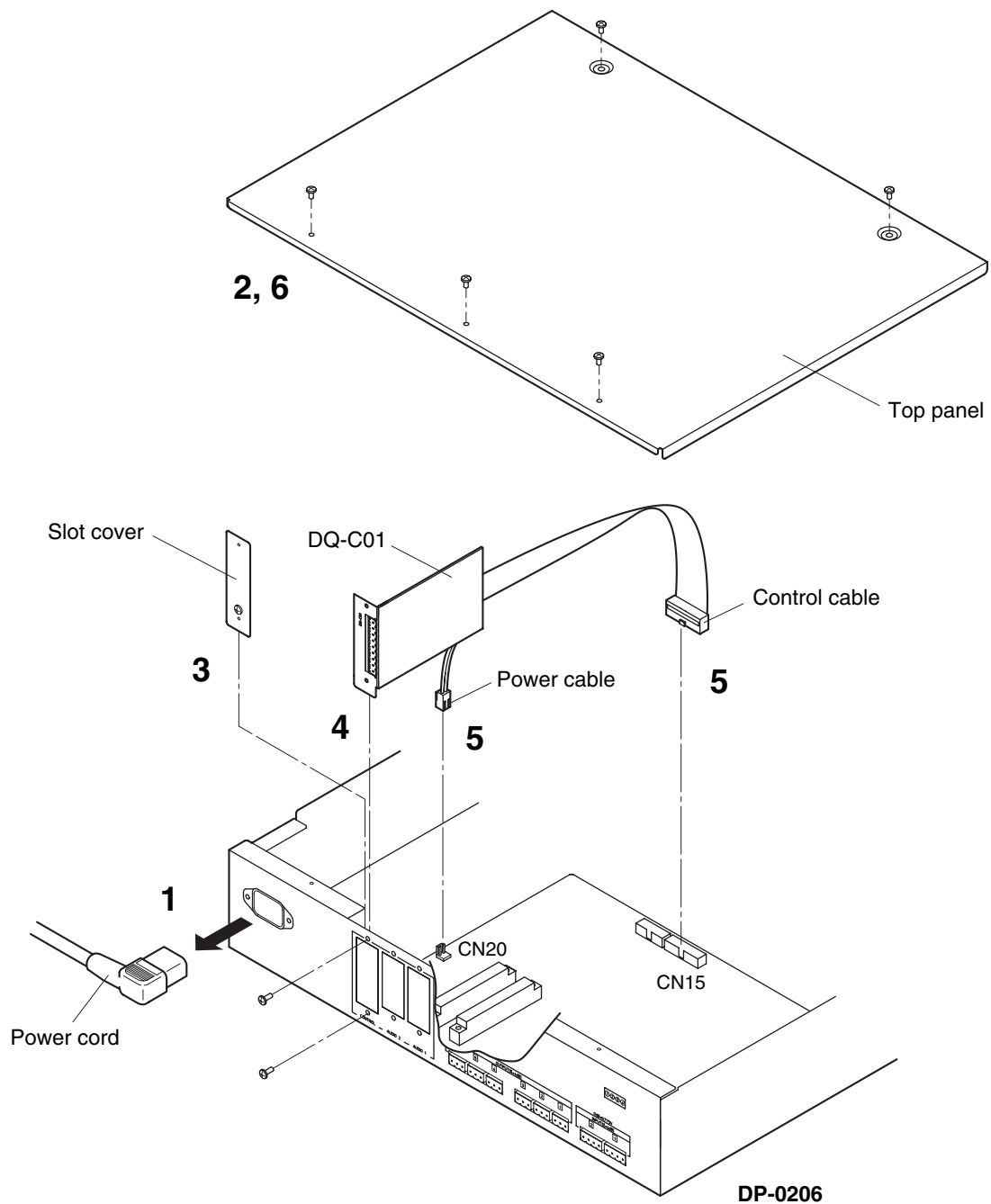

7.2. Input/Output and Control Cable Connections

Connect external input/output cables to the unit's rear panel-mounted input/output connectors (terminal block type connectors). Perform the following connections depending on the type of equipment to be connected.

• Input connector

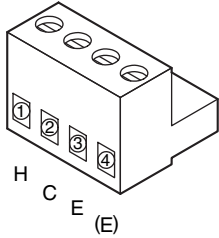

Input connector pin No.	① H	② C	③ E	④ (E)
Balanced connection	Hot	Cold	Ground	Ground (Use only when hum noise is generated.)
Unbalanced connection	Signal line	Ground		

Cautions

- Connect the grounding line to Pins 2 and 3 or to Pins 2 and 4 in the event of an unbalanced line connection.
- The maximum input level is 20 dB (0 dB=0.775 V) when connected with an unbalanced line.

Tip

When an input source is connected to the unit, a ground loop may be created, generating hum noise. In such cases, change the ground line connection from Pin 3 to Pin 4 to cut the loop.

• Output connector

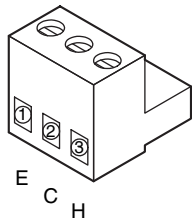

Output connector pin No.	① E	② C	③ H
Balanced connection	Ground	Cold	Hot
Unbalanced connection		Ground	Signal line

Cautions

- Connect the grounding line to Pins 1 and 2 in the event of an unbalanced line connection.
- The maximum output level is 20 dB (0 dB=0.775 V) when connected with an unbalanced line.

• Control connector

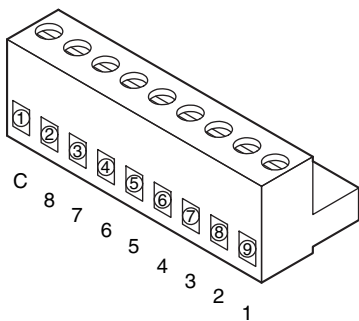

Control connector pin No.	① C	② 8	③ 7	④ 6	⑤ 5	⑥ 4	⑦ 3	⑧ 2	⑨ 1
Terminal function	Common	Terminal 8	Terminal 7	Terminal 6	Terminal 5	Terminal 4	Terminal 3	Terminal 2	Terminal 1

Cautions

- Be sure to use shielded cables for audio signal lines.
- When using stranded or shielded cables, avoid tin-lead plating over the stripped cable end

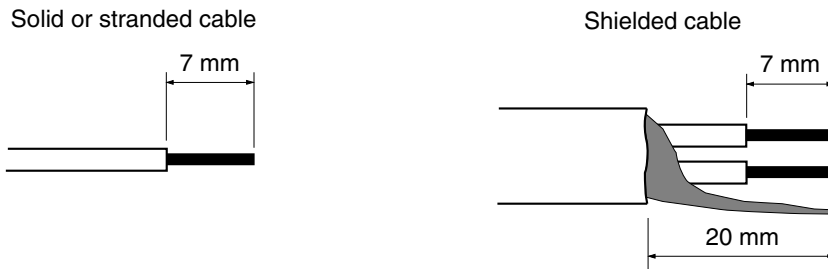

Connector connections

- Step 1.** Detach the unit's rear panel-mounted input/output connector (terminal block type connector) from the unit.
- Step 2.** Loosen the terminal screw, then insert the cable.
- Step 3.** Retighten the terminal screw. (Pull on the cable to ensure it is securely connected.)
- Step 4.** Remount the input/output connector to the unit.

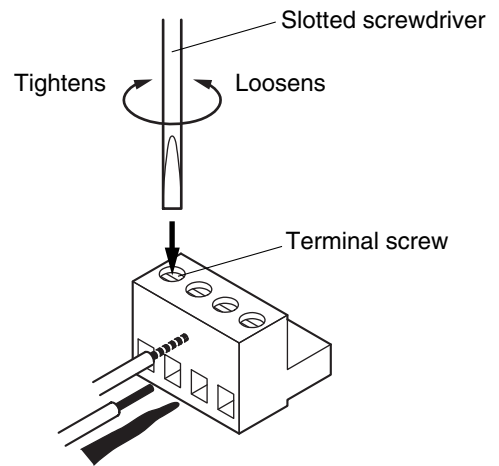

Tip

Recommended slotted screwdriver type: Screwdriver with blade that is 3 mm in width

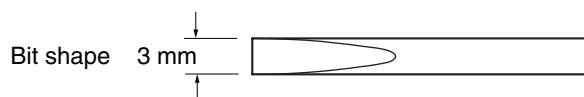

7.3. Connections between Units

Using the unit's rear panel-mounted RS-485 port, up to 30 units can be connected. It is possible to control such connected units with a single PC or simultaneously switch their pattern memories from the master unit.

Connection method

Using 2-core shielded cables, connect the unit's RS-485 port connector to that of other unit as shown below. (Refer to p. 22 "RS-485 Transmission Cable.")

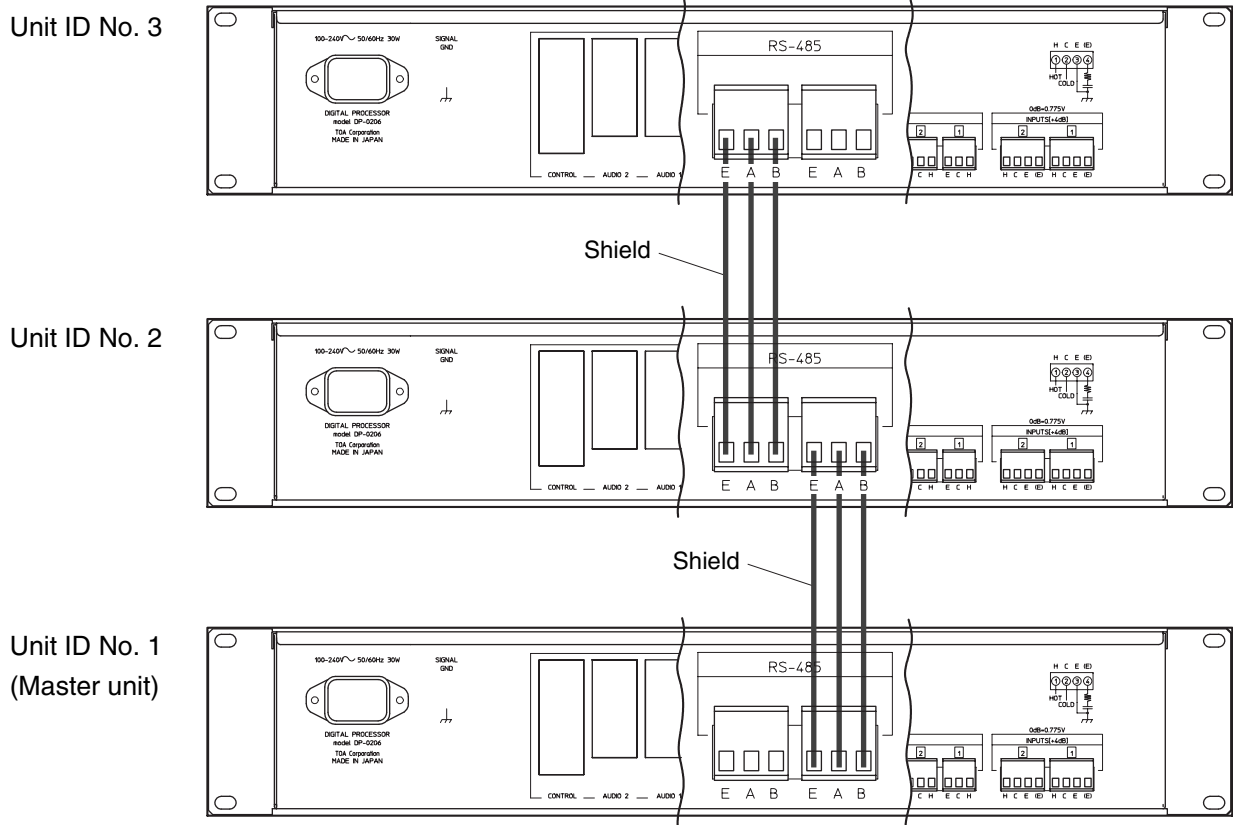

Tips

- Connection order has no relationship to the ID number. Connect units which are installed closest to each other for the shortest cable routing.
- Either the left or right connector can be used.
- Connectors can also be wired as follows:



7.4. Input/Output Configuration Settings and Confirmation

7.4.1. Input/Output configuration settings

Follow the procedures below to set the I/O configuration when an optional DQ-A01 Analog Input Module or DQ-A02 Analog Output Module has been mounted or detached:

Caution

If the I/O configuration setting is performed, the Unit ID numbers and all other parameters will be initialized and reset to the factory-preset mode. After completing this setting, be sure to set the parameters with a PC, and the ID number as well before using the unit.

Step 1. Turn on the power.

Step 2. Disable the System Lock function by shifting the System Lock key to the left.

Step 3. Press and release the Reset key while holding down the Memory Recall key.

Step 4. Release the Memory Recall key when the "In" indication is displayed on the Memory/Unit ID Number display.

The "In" indication flashes showing that the I/O configuration is automatically set and the parameters are initialized.

Step 5. Confirm the Input/Output level indicators.

The I/O configuration status is shown as follows by the corresponding channel lamps only while the "In" is flashing.

- Lighting green: The module has been installed correctly.
- Lighting orange: The necessary module has not been installed. Check the module installation position.
- Flashing red: The module has been installed in the incorrect position. Because the unit does not operate, reinstall the module correctly and set the I/O configuration again.

Step 6. After the "In" continues to flash for ten and several seconds, the display changes to indicate the communication speed of the RS-485 (refer to p. 23 "Changing the RS-485 Communication Speed.") and the unit's firmware version in sequence. Then, the display flashes "Id" indicating that the Unit ID number must be set. (Refer to p. 16 "Unit ID Number setting.")

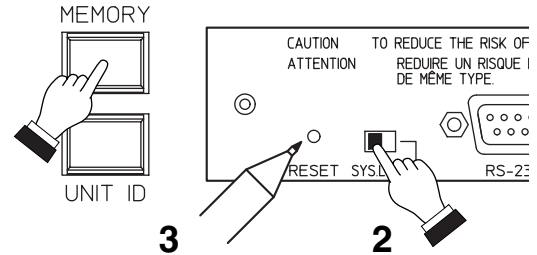

7.4.2. Input/Output configuration confirmation

To confirm the latest I/O configuration setting, including the module-expanded configuration, simultaneously press both the Memory Recall key and the Unit ID Number Display key. The indication of "Io" will then be displayed on the Memory/Unit ID Number display and the current configuration setting is displayed as described in Step 5 above.

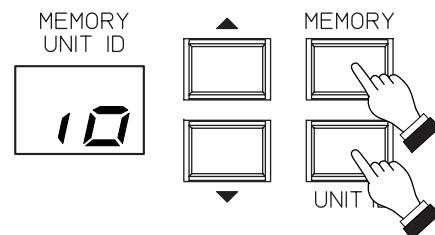

Note

When the corresponding indicators light red, this indicates that the I/O configuration has not been set (See above procedure).

7.4.3. Default signal flow

Signal flow is factory-preset as follows depending on the input/output configuration:

Note: For signal flow changes, refer to the software instruction manual.

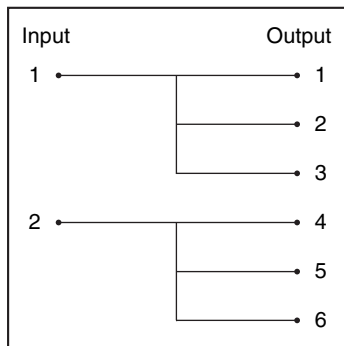

2-IN/6-OUT

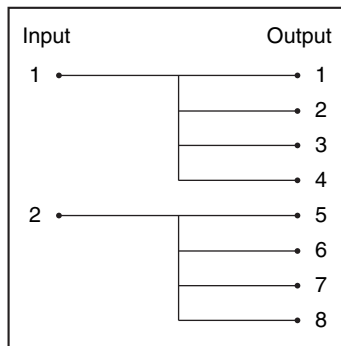

2-IN/8-OUT

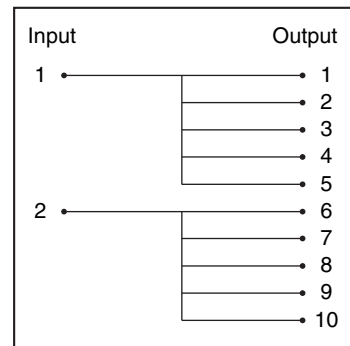

2-IN/10-OUT

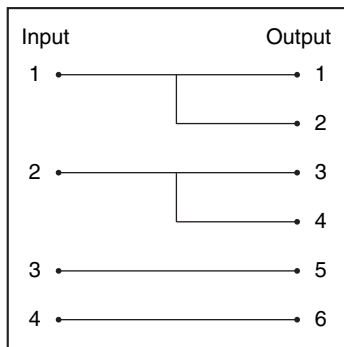

4-IN/6-OUT

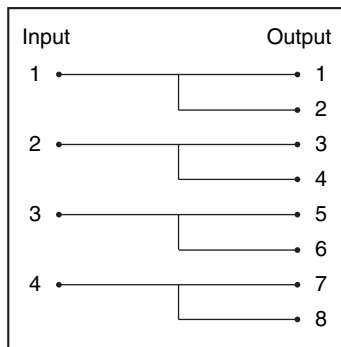

4-IN/8-OUT

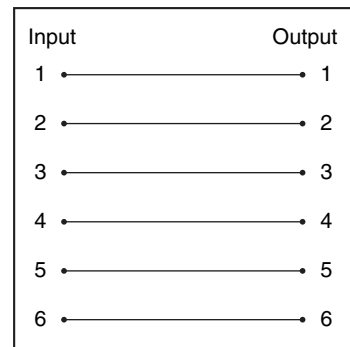

6-IN/6-OUT

7.5. Unit ID Number Setting and Confirmation

Note that the Unit ID number setting must be performed when controlling the unit from a PC. Since the ID number is not preset when the unit is supplied from the factory, be sure to set it after you purchase the unit.

7.5.1. Unit ID Number setting

If the "Id" indication flashes on the Memory/Unit ID Number display following the unit's initialization or I/O configuration setting, set the Unit ID number.

MEMORY
UNIT ID



[Single unit]

Set the unit for Unit ID No. 1.

Step 1. Press the Unit ID Number display key.

The indication of "1" will flash on the Memory/Unit ID Number display.

Step 2. Release the ID number key.

The setting is completed. (Note that the display continues to flash.)

[Multiple units]

Set consecutive ID numbers beginning with "1", which are automatically assigned to the units in setting order.

Notes

- Make connections of the rear panel-mounted RS-485 port before using. (Refer to p. 14 "Connections between Units.")
- The unit set for ID No. 1 functions as a master unit.

Step 1. Press and hold down the Unit ID Number display key on the unit.
The ID number of the unit is automatically set and will appear and flash on the Memory/Unit ID Number display.

Step 2. Release the ID number key.
The unit's ID number setting is completed.

Note: The indication of the selected ID number continues to flash on the display even after its setting completion.

Caution: For the second unit and its subsequent units, the ID number is set when the Master indicator is extinguished after illuminating for about 1 second. To avoid the duplication of the ID number, do not make settings of other units during this time.

Step 3. Repeat Steps 1 and 2 above for all units.

7.5.2. Changing the Unit ID Number

Step 1. Press the Memory/Unit ID Number selector key to change the number while holding down the Unit ID Number display key (the display quickly flashes).

Step 2. Select the desired number and release the ID number display key. The new number is set (the display continues to flash even after setting completion).

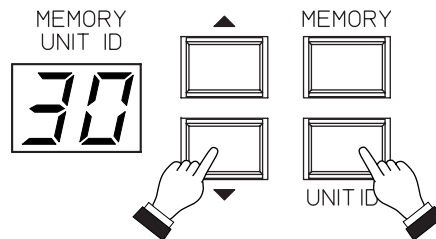

Cautions

- Take care not to assign duplicate Unit ID numbers. If duplicated, the unit number cannot be changed and the indication of "Id" flashes on the Memory/Unit ID number display. In such cases, perform the ID number setting again. (Refer to p. 16 "Unit ID number setting.")
- When the Master indicator on two or more units simultaneously light, the function of a single-PC control or simultaneous pattern switching is disabled. To enable such functions, connect all of the units' RS-485 ports to permit only the ID No. 1 unit's Master indicator to light.

7.5.3. Unit ID Number confirmation

Pressing the Unit ID Number Display key causes the indication of the set ID number to quickly flash on the Memory/Unit ID Number display. When multiple DP-0206 units are connected, if the Unit ID Number Display key on any one of them is pressed, the corresponding ID number will be displayed on each unit.

7.6. PC Connections

The DP-0206 processor is not provided with on-board parameter setting functions. To set parameters, a PC with dedicated software installed is required. Up to 30 units can be simultaneously controlled from the PC. After the parameters set with the PC are stored in each unit's memory, the unit can be used without the PC connecting to the unit.

There are two methods of connecting the unit to the PC; using the RS-232C port, or using the RS-485 port.

7.6.1. RS-232C connections

Connect the unit's RS-232C communication port located inside the front panel-mounted security cover or on the rear panel to the PC's RS-232C port by means of a straight cable shorter than 10 m. When controlling multiple units by means of a single PC, connect the PC to the unit set for Unit ID No. 1.

Shown below are RS-232C control specifications:

Baud rate 115200 bps
 Parity Non-parity
 Data 8 bits
 Stop bit 1 bit

Note

The maximum transmission distance between the unit and the PC is 10 m when connected using the RS-232C port. When the distance to the PC exceeds 10 m, use the RS-485 port for connection. (Refer to p. 19 "RS-485 Connections.")

DP-0206 Front

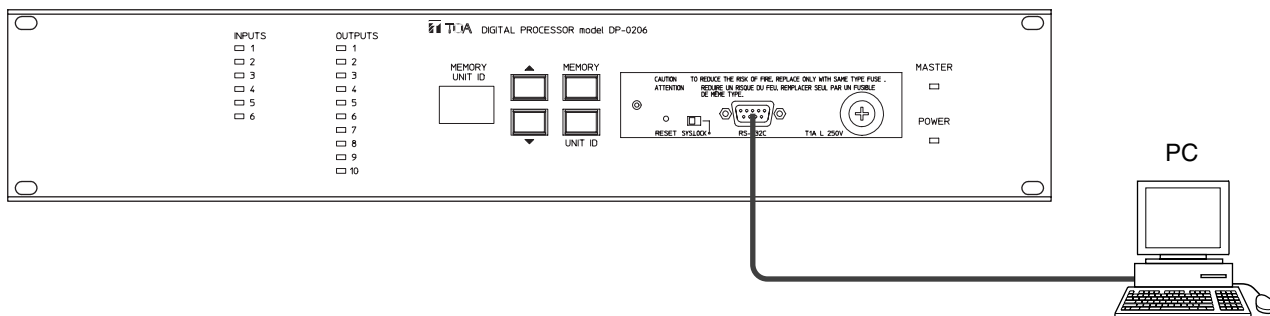

DP-0206 Rear

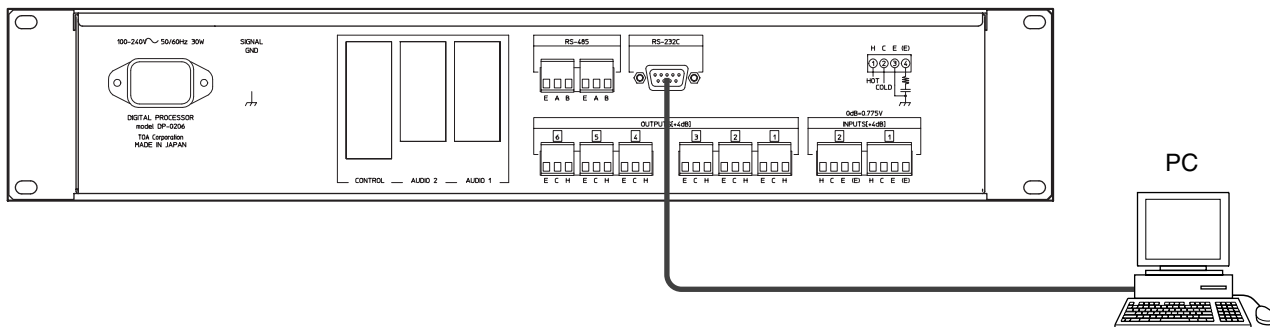

Caution

When multiple units are connected, if the PC is connected to the unit set for Unit ID number other than "1," only the PC-connected unit can be controlled. Other units cannot be controlled.

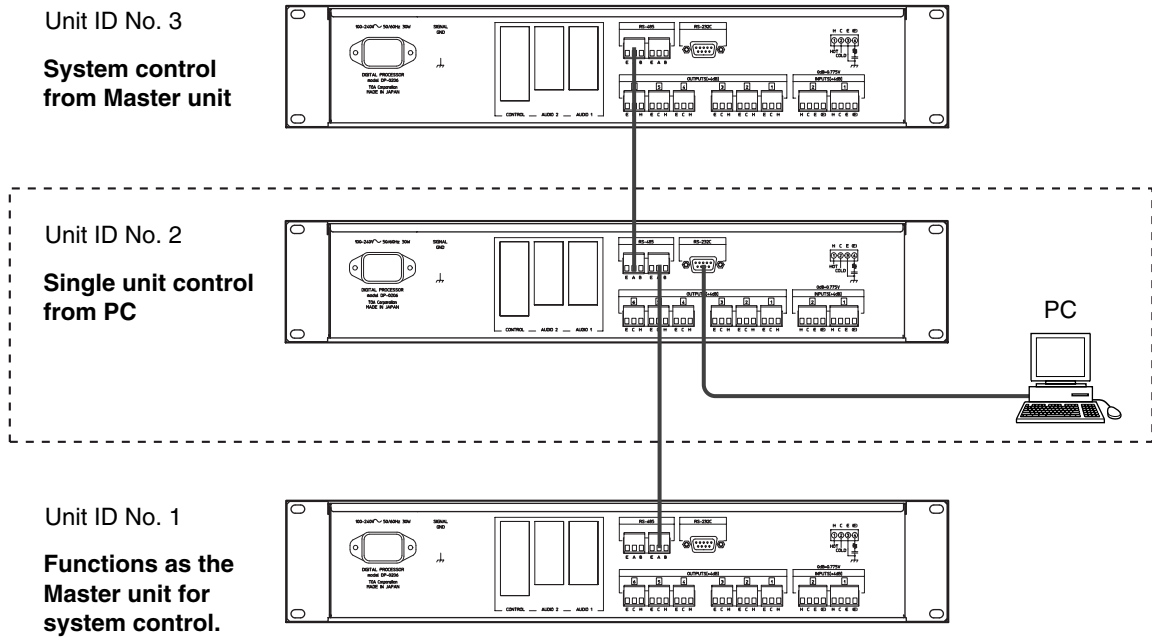

7.6.2. RS-485 connections

When the transmission distance to a PC is longer than 10 m, connect to the RS-485 communication port. Because the normal type of PC has only the RS-232C port, a conversion adapter for converting RS-232C to RS-485 is required. (Refer to p. 22 "RS-232C/RS-485 Converter.") Connect the adapter to the PC's RS-232C port, then connect it to the unit's RS-485 port (either of the two ports may be used).

DP-0206 Rear

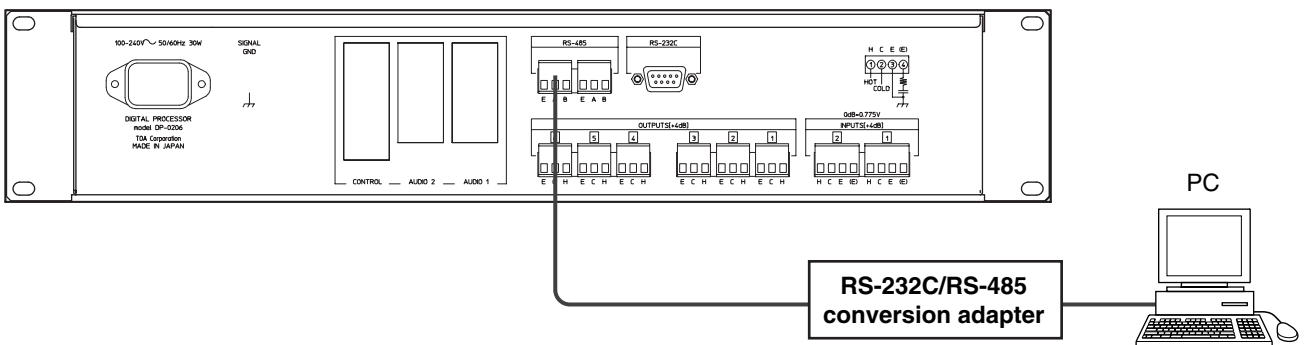

7.7. Pattern Memory Recall

The setting of the unit's parameter requires a PC with dedicated software installed. However, after storing the setting status in 16 memories, the pattern memory can be recalled from the unit even if the PC is not connected.

When multiple units are connected, the unit set for ID No. 1 functions as the master unit. Recalling the pattern memory from the master unit causes all other connected units to recall the same pattern memory as that of the master unit.

Follow the procedures below to recall pattern memories:

Step 1. Press the Memory Recall key.

Step 2. Press the front panel-mounted Memory/Unit ID Number selector key to select the desired memory number shown on the display. (The display flashes slowly.)

Step 3. Press the Memory Recall key again. The display stops flashing and the pattern memory of the displayed number is recalled.

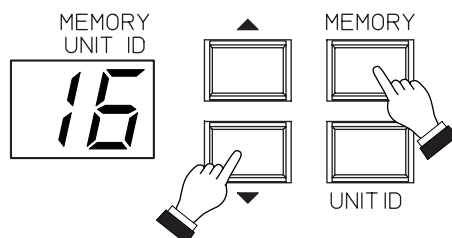

Caution

When the unit other than the master unit is also connected to a PC using the RS-232C port, that unit's pattern memory does not change if the memory pattern is switched at the master unit.

Tip

Besides the method mentioned above, pattern memories can be recalled from a PC or from external equipment using the optional DQ-C01 Remote Control Module. Refer to the software instruction manual for details.

8. APPENDIX

8.1. System Lock Function

Two different types of system lock are made available to disable specific front panel functions.

[System Lock 1]

Operations to be disabled: Initialization (p.22), Unit ID number change (p.17), and communication speed change (p.23)

How to lock: Shift the System Lock switch to the right.

[System Lock 2]

Operations to be disabled: Initialization (p. 22), Unit ID number change (p. 17), communication speed change (p. 23), and pattern memory change (p. 20).

How to lock: Shift the System Lock switch to the right while pressing the Memory Recall key.

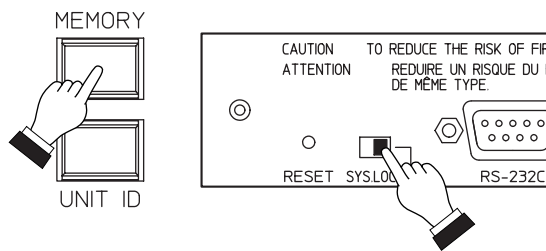

8.2. Propagation Delay

It takes 1.4 ms for input signal applied to the analog input terminal to be transmitted to the analog output terminal. When the delay is set, its value is added to the 1.4 ms. Propagation delay values are not affected by other signal processing settings.

8.3. Display Conditions of the Memory/Unit ID Number Display

Operation Mode	Display Condition	Flashing Cycle	Flashing Method
Memory No. being displayed	Remains lit	None	None
Memory No. being selected	Flashes slowly	640 ms	
Unit ID No. being displayed	Flashes quickly	200 ms	
I/O configuration being displayed	Flashes quickly	200 ms	
Communication speed being displayed	Flashes quickly	200 ms	
Data being edited by means of a PC	Flashes in the special manner	960 ms	

8.4. Error Indications

Error No.	Action
E1	These errors were detected by the unit's internal CPU. If these error indications continue to be displayed after the power has been switched off and on, contact your nearest TOA dealer or the dealer from where the unit was purchased.
E2	
E3	
E4	

8.5. Initialization

Restores unit to default settings. (All programmed parameters are erased.) The operating method is the same as that for the input/output configuration setting. (Refer to p. 15 "Input/output configuration settings.")

8.6. Rack Mounting

Several units can be stacked.

Caution: Do not install the unit directly on top of an amplifier or other heat-generating equipment.

8.7. RS-232C/RS-485 Converter

Use an adapter having a CTS terminal.

Recommended model: Serial converter RU-SC1A
 RDL (Radio Design Labs)
 URL: <http://www.rdl.net.com/>

[RS-485 connector connection]

DP-0206	① E	② A	③ B
RU-SC1A	①	③	②

When connecting the converter to a PC, use an RS-232C straight cable.

8.8. Junction Connectors for Input/Output Connectors

To connect the input and output cables directly, use the connector below:

Recommended model: Pinheaders Type SL5.08 KU4 (part No. 159778)
 Weidmüller
 URL: <http://www.weidmüller.de/>

8.9. RS-485 Transmission Cable

Use the cables that comply with the AES/EBU or IEC Standard. Microphone cables maybe used if the cable length is shorter than approximately 10 meters.

8.10. Changing the RS-485 Communication Speed

The unit's RS-485 communication speed is preset to 115200 bps by the factory. To increase the cable distance, decreasing the communication speed permits highly-reliable transmissions. It is recommended that the communication speed be changed when the cable length exceeds 100 m.

Cautions

- Decreasing the communication speed also slows down the unit's response to the instructions from a PC.
- Change the communication speed only at the master unit.

Follow the procedures below to change the communication speed:

Step 1. Shift the System Lock switch to the left to disable the System Lock function.

Step 2. Press and release the Reset key while holding down the Unit ID Number Display key.

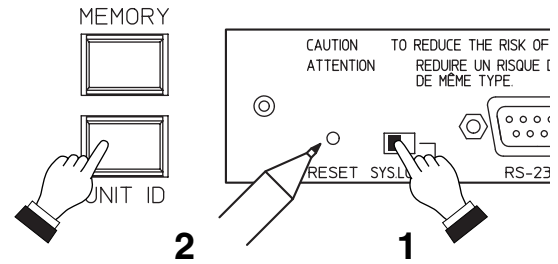

Step 3. Release the Unit ID Number Display key when the "Co" indication is displayed on the Memory/Unit ID Number display.



Step 4. The following indications flash on the display to show the current communication speed setting:

- [CH]: 115200 bps
- [C3]: 38400 bps
- [C2]: 19200 bps
- [C1]: 9600 bps

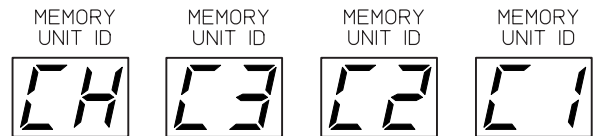

Step 5. Select the communication speed using the Memory/Unit ID Number Selector key.

Step 6. Press the Memory Recall key to set the selected speed.

8.11. Recalling Pattern Memory Using the Memory Selector

The DK-1608 Memory Selector is used to recall pattern memory stored in the DX-0808 Matrix Unit, etc. The two methods used to recall the unit's stored pattern memory using the DK-1608 will be explained. (Refer to the DK-1608 Instruction Manual for information on the DK-1608's specifications and operation.)

8.11.1. Using the unit's RS-232C communication port

[Communication port settings]

Follow the below procedure to reset the unit's RS-232C communication port for use with the DK-1608.

Notes

- Perform the following operation on the unit to be designated as the Master unit (Unit ID = 1). (This operation cannot be performed on any other unit than the Master unit.)
- Match the communication speed with that of the DK-1608.

Step 1. Shift the System Lock switch to the left.

Step 2. Press the Reset key while holding down the Memory/Unit ID Number selector's DOWN (▼) key. (Continue to press the DOWN key even after the Reset key has been pressed.)

Step 3. (While holding down the DOWN key.) Shift the System Lock switch to the right when the Memory/ID Number Display shows the "Pd" indication. The indication will change to "P.d".

Step 4. (While holding down the DOWN key.) Shift the System Lock switch to the left, and the indication will change to "P1".

Step 5. Releasing the DOWN key here sets the communication speed to 9600 bps. (This completes the setting if the speed is to be set to 9600 bps.) To set the communication speed to 19200 bps or 38400 bps, shift the System Lock switch to the right WITHOUT releasing the DOWN key. The indication will then change to "P.1".

Step 6. Shift the System Lock switch to the left, changing the indication to "P2".

Step 7. Releasing the DOWN key here sets the communication speed to 19200 bps. (This completes the setting if the speed is to be set to 19200 bps.) To set the communication speed to 38400 bps, shift the System Lock switch to the right while continuing to hold down the DOWN key. The indication will change to "P.2".

Step 8. Shift the System Lock switch to the left, changing the indication to "P3".

Step 9. Releasing the DOWN key sets the communication speed to 38400 bps.

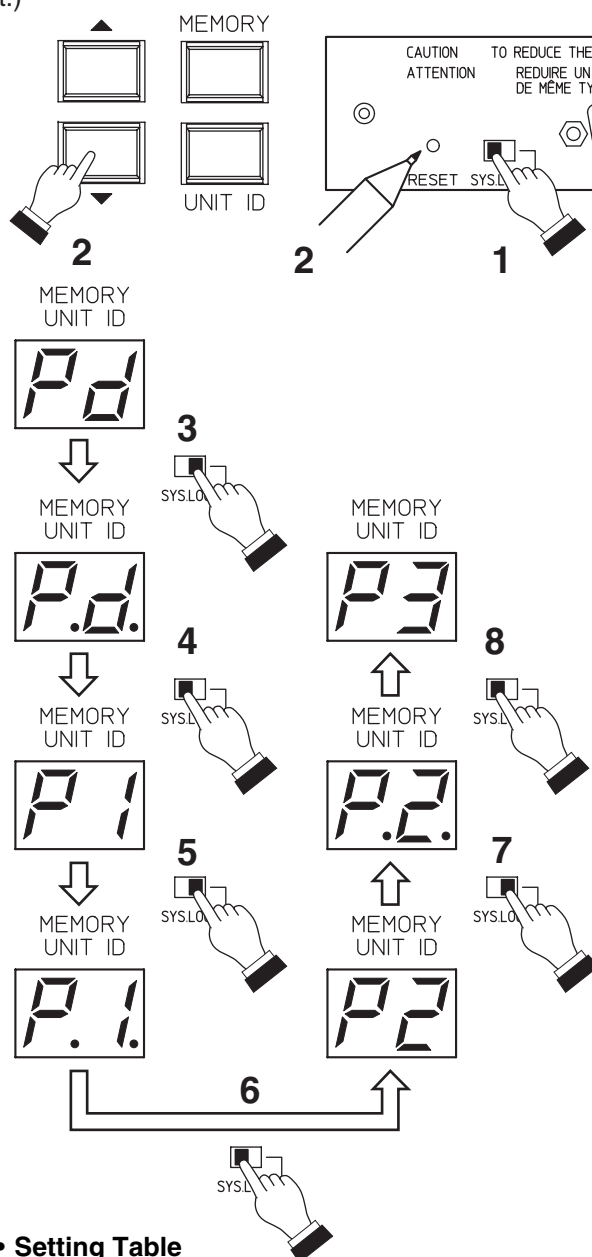

• Setting Table

Display (timing to release the Down Key)	communication speed
P1	9600 bps
P2	19200 bps
P3	38400 bps

Follow the below procedure to return the unit's RS-232C communication port to its factory-preset condition.

Step 1. Shift the System Lock switch to the left.

Step 2. Press the Reset key while holding down the Memory/Unit ID Number selector's Up (▲) key. (Continue to hold down the Up key even after the Reset key has been pressed.)

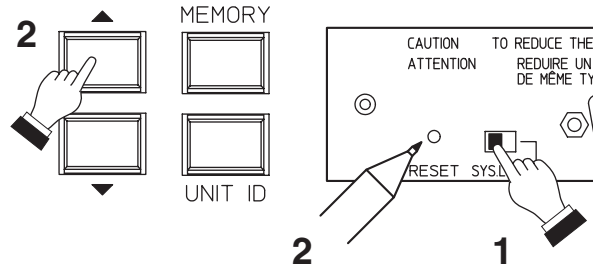

Step 3. (While holding down the UP key.) Shift the System Lock switch to the right when the Memory/ID Number Display shows the "P1", "P2" or "P3" indication. The indication will change to "P.1", "P.2." or "P.3.".

(Example where the transmission rate has been set to P1)

Step 4. (While holding down the Up key.) Shift the System Lock switch to the left, changing the indication to "Pd".

Step 5. Release the Up key.

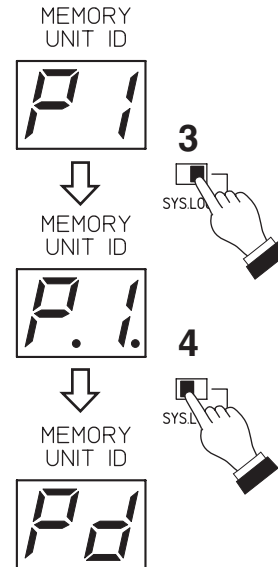

[Connection]

Connect the Master unit's RS-232C port to the DK-1608's RS-232C port using the reverse cable.

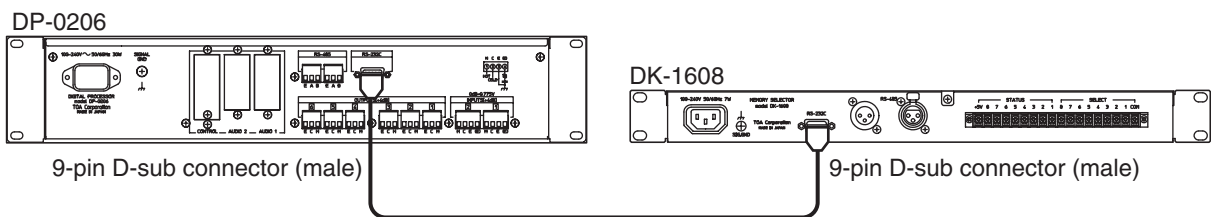

When the distance between the Master unit and the DK-1608 is 10 m or more, use an RS-232C/RS-485 converter to convert to RS-485, then connect to the DK-1608's RS-485 communication port.

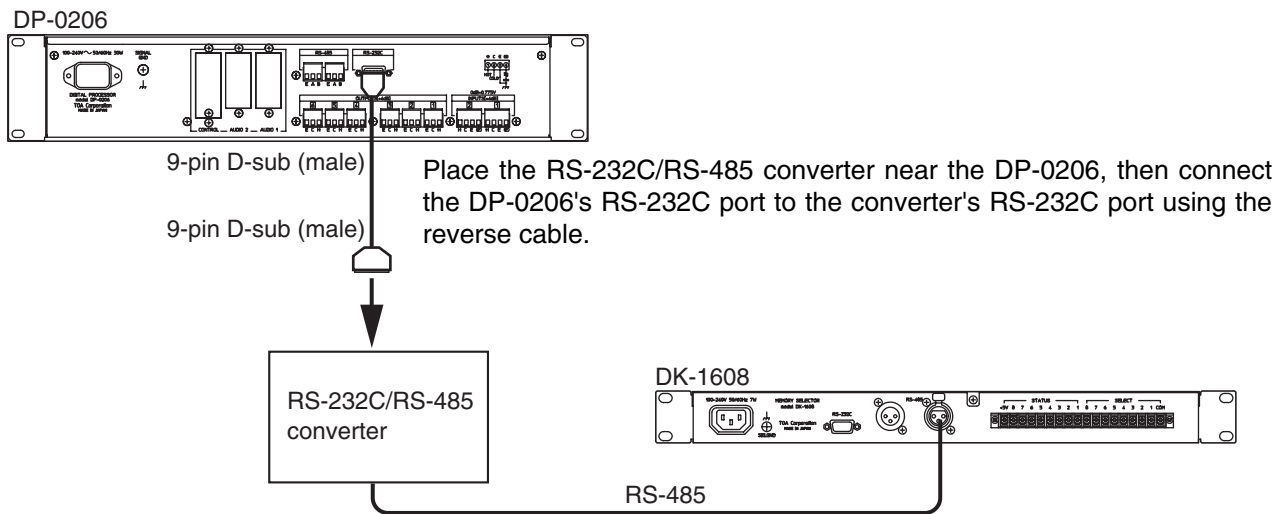

Connect the RS-232C/RS-485 converter's RS-485 communication port to the DK-1608's RS-485 port using the twisted pair cable. (Refer to P. 22, RS-485 Transmission Cable.)

• **DK-1608 Converter connection**

Converter side	DK-1608 side
+ (positive) or A	XLR connector Pin 3
- (negative) or B	XLR connector Pin 2
S.G. (signal ground) or E	XLR connector Pin 1

Caution

Only switch on the DK-1608's power AFTER the unit's power has been switched on.

Notes

- Refer to P. 22 of this manual for the RS-232C/RS-485 converter.
- The following tables show the reverse cable wiring.

Unit side 9-pin D-sub (male)	DK-1608 or RS-232C/RS-485 converter side 9-pin D-sub (male)	Remark
2	3	
3	2	
4	6	No problem even when unconnected.
5	5	
6	4	No problem even when unconnected.
7	8	No problem even when unconnected.
8	7	No problem even when unconnected.
Shell	Shell	No problem even when unconnected.

- When the unit's RS-232C port is set for use with the DK-1608, the unit's Master indicator rapidly flashes. (Flashes at normal speed while communicating with a PC.)

8.11.2. Using the Remote Control Module

Note

This method can only be used when the DX-0808 Matrix Unit or DI-1616 Interface Unit is connected to the DK-1608 Memory Selector. When only the unit is connected to the DK-1608, use the unit's RS-232C communication port to recall the pattern memory as explained above.

[DQ-C01's connection to the DK-1608]

Install the DQ-C01 Remote Control Module in the unit. Connect the DK-1608's COM terminal to the DQ-C01's C terminal, and the DK-1608's STATUS terminal to the DQ-C01's 1 – 8 terminals.

Note

It is highly recommended that the DQ-C01 be installed in the Master unit (Unit ID = 1). Doing otherwise could require an excessively long interval before the pattern memory is recalled from the DK-1608.

[DQ-C01 setting]

The DK-1608's STATUS terminal corresponds to the front panel-mounted selection keys (1 – 8).

The memory number corresponding to each selection key can be set at the DK-1608's rotary switch, however the DQ-C01 also needs to match this setting. This change can be made by selecting [Option (O) → External control setting (C)] in the unit's setting software. For details, refer to the accompanying Software Instruction Manual.

Notes

- The unit's protocol differs from that of the DX-0808 and DI-1616. It is impossible to control both the unit and the DX-0808 or DI-1616 over the same communication line (RS-232C or RS-485). Therefore, install separate communication lines for the system consisting of the unit and the DX-0808 or DI-1616. In the above-noted method of using unit's RS-232C communication port, the communication line of the DX-0808 or DI-1616 may in some cases be connected to the unit's RS-232C port. However, the only control that can be performed from this line to the unit is pattern memory recall.
- In a system where the unit and a DX-0808 or DI-1616 are combined, avoid recalling the pattern memory at the DK-1608 or DX-0808 while a PC is being used to set the unit. Similarly, do not recall the pattern memory from either the unit or the DK-1608 while a PC is being used to set the DX-0808 or DI-1616.

8.12. Controlling the Remote Control Module's Terminals

This section describes how to control the DQ-C01 Remote Control Module's terminals when recalling the pattern memory, adjusting output sound volume, or controlling output signal muting by way of connected external equipment. (For the settings of each function, please refer to the accompanying Software Instruction Manual.)

8.12.1. Pattern memory recall

There are two different modes for recalling the pattern memory: Direct mode and Binary mode. In Direct mode, one of terminals 1 – 8 is shorted to the C terminal and up to 8 pattern memories can be controlled. In Binary mode, two or more terminals can be shorted or opened to the C terminal, and up to 16 pattern memories can be controlled.

[Direct mode]

The following (A) and (B) control methods are available. In both cases, the pattern memory is switched when more than 500 milliseconds pass after each terminal has been shorted to the C terminal.

(A) Terminals remain shorted even after the pattern memory has been switched.

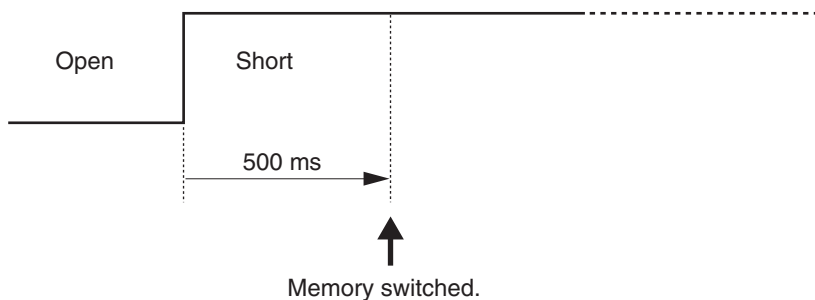

(B) Terminals are opened after the pattern memory has been switched.

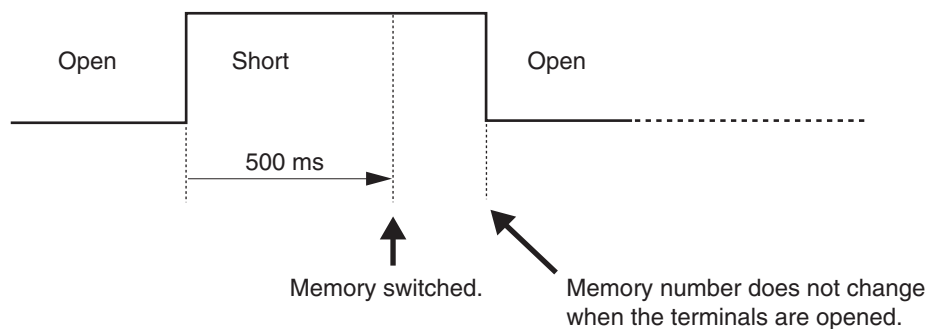

Tip

Terminals 1 – 8 are assigned to each pattern memory using the setting software. For details, refer to the accompanying Software Instruction Manual.

[Binary mode]

The following tables show the relationship between the state to be assigned to the terminal and the pattern memory to be recalled:

(In the tables, [O] stands for a short circuit, and [-] stands for an open circuit.)

- Selecting 2 Memories using Terminal 8

Memory No.	Terminal 8
1	O
2	-

- Selecting 4 memories using Terminals 7 and 8

Memory No.	Terminal 7	Terminal 8
1	O	O
2	O	-
3	-	O
4	-	-

- Selecting 8 memories using Terminals 6, 7 and 8

Memory No.	Terminal 6	Terminal 7	Terminal 8
1	O	O	O
2	O	O	-
3	O	-	O
4	O	-	-
5	-	O	O
6	-	O	-
7	-	-	O
8	-	-	-

- Selecting 16 memories using Terminals 5, 6, 7 and 8

Memory No.	Terminal 5	Terminal 6	Terminal 7	Terminal 8
1	O	O	O	O
2	O	O	O	-
3	O	O	-	O
4	O	O	-	-
5	O	-	O	O
6	O	-	O	-
7	O	-	-	O
8	O	-	-	-
9	-	O	O	O
10	-	O	O	-
11	-	O	-	O
12	-	O	-	-
13	-	-	O	O
14	-	-	O	-
15	-	-	-	O
16	-	-	-	-

The pattern memory is switched if the corresponding state is assigned to the desired pattern memory and is maintained for more than 500 ms. Maintain the terminal state until the pattern memory is next switched.

8.12.2. Output volume adjustment

As with the pattern memory, Direct mode and Binary mode are also available.

Notes

- Output volume can only be adjusted for the unit in which the DQ-C01 Remote Control Module is installed.
- The output volume adjustment is a function to provide the output attenuator setting with an offset.
Switching off the power clears the offset value, and returns the output attenuator to the preset value.

[Direct mode]

- Short the connection between the numbered terminal and the C terminal for an interval of 500 ms (less than 700 ms), then open. The volume will vary by 1 step*.
- * Select from 1 dB step/3 dB step/6 dB step using the setting software.

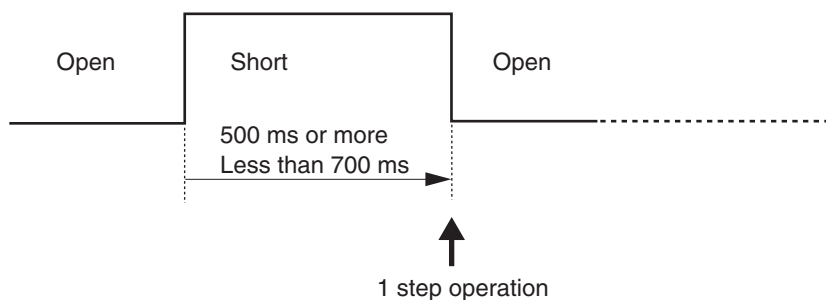

- Continuing to short the connection for 700 ms or more changes the volume by 1 step every 500 ms. This continuous operation stops if the connection is opened.

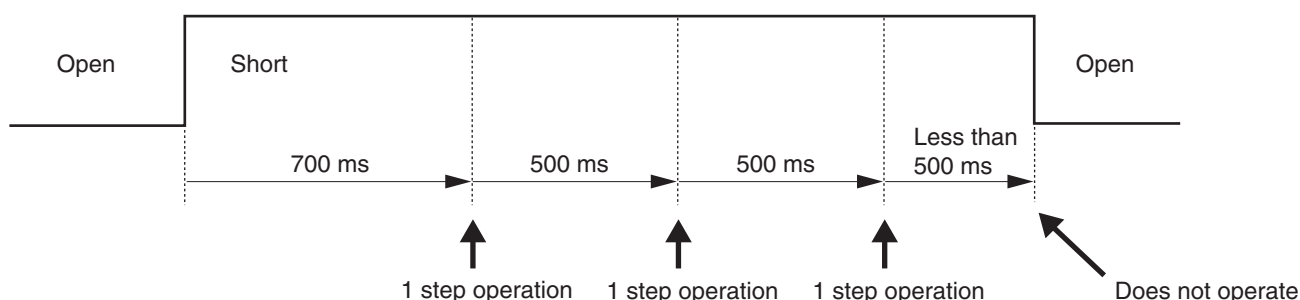

Tip

Use the setting software to assign terminals.
Refer to the Software Instruction Manual.

[Binary mode]

The following tables show the relationship between the state to be assigned to the terminal and the operation group.
(In the tables, [O] stands for a short circuit, and [-] stands for an open circuit.)

- Increasing/Decreasing the volume of 3 groups using Terminals 6 – 8

Group	Terminal 6	Terminal 7	Terminal 8
1 Up	O	O	O
1 Down	O	O	-
2 Up	O	-	O
2 Down	O	-	-
3 Up	-	O	O
3 Down	-	O	-

Note: Terminals 6 – 8 are assumed to be normally open.

- Increasing/Decreasing the volume of 7 groups using Terminals 5 – 8

Group	Terminal 5	Terminal 6	Terminal 7	Terminal 8
1 Up	○	○	○	○
1 Down	○	○	○	–
2 Up	○	○	–	○
2 Down	○	○	–	–
3 Up	○	–	○	○
3 Down	○	–	○	–
4 Up	○	–	–	○
4 Down	○	–	–	–
5 Up	–	○	○	○
5 Down	–	○	○	–
6 Up	–	○	–	○
6 Down	–	○	–	–
7 Up	–	–	○	○
7 Down	–	–	○	–

Note: Terminals 5 – 8 are assumed to be normally open.

- Increasing/Decreasing the volume of 10 groups using Terminals 4 – 8

Group	Terminal 4	Terminal 5	Terminal 6	Terminal 7	Terminal 8
1 Up	○	○	○	○	○
1 Down	○	○	○	○	–
2 Up	○	○	○	–	○
2 Down	○	○	○	–	–
3 Up	○	○	–	○	○
3 Down	○	○	–	○	–
4 Up	○	○	–	–	○
4 Down	○	○	–	–	–
5 Up	○	–	○	○	○
5 Down	○	–	○	○	–
6 Up	○	–	○	–	○
6 Down	○	–	○	–	–
7 Up	○	–	–	○	○
7 Down	○	–	–	○	–
8 Up	○	–	–	–	○
8 Down	○	–	–	–	–
9 Up	–	○	○	○	○
9 Down	–	○	○	○	–
10 Up	–	○	○	–	○
10 Down	–	○	○	–	–

Note: Terminals 4 – 8 are assumed to be normally open.

- Assign the state corresponding to Increase/Decrease of the group the volume of which is to be adjusted to the terminal to be used and maintain the state for 500 ms or more (less than 700 ms). Opening all terminals to be used varies the volume by 1 step.

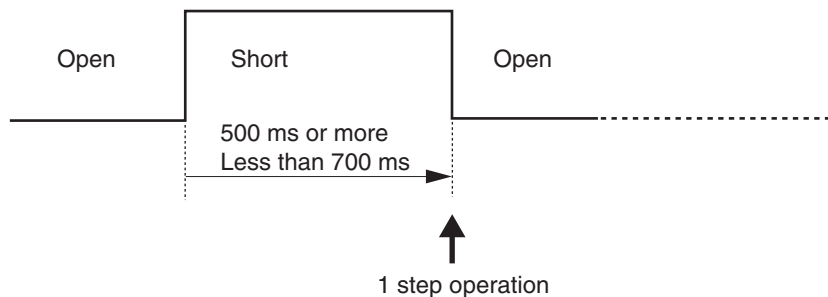

- Continuing to short the connection for 700 ms or more changes the volume by 1 step every 500 ms. This continuous operation stops if the connection is opened.

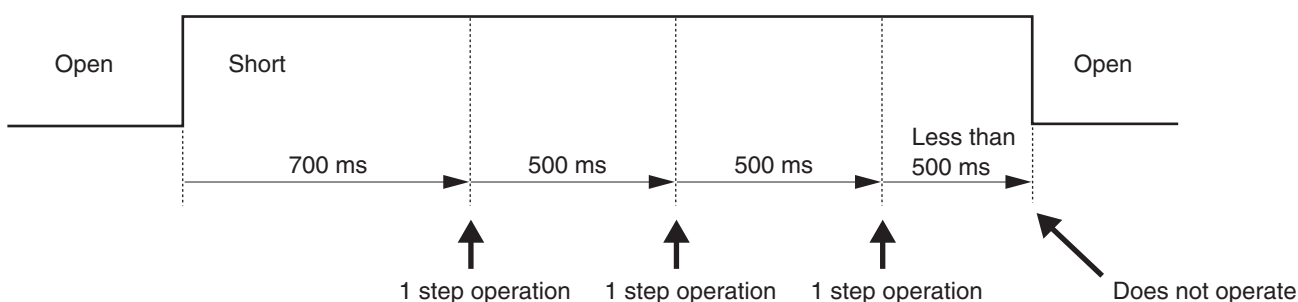

Note

Use the setting software to set groups.
Refer to the Software Instruction Manual.

8.12.3. Output muting

Two types of muting are available: Make operation, which mutes the signal while the connection between each terminal and the C terminal is shorted, and Pulse operation, which turns muting ON and OFF each time the terminals are shorted. Use the setting software to select the desired type of operation.

Notes

- Output muting can be performed only for the unit in which the DQ-C01 Remote Control Module is installed.
- Muting cannot be turned OFF at the DQ-C01 for channels which have been programmed by the setting software to have muting ON.
- Muting performed by the DQ-C01 is turned OFF if the power is switched off.

[Make operation]

Muting is turned ON if its terminal is shorted with the C terminal for 500 ms or more, and turned OFF if the terminals are opened for 500 ms or more.

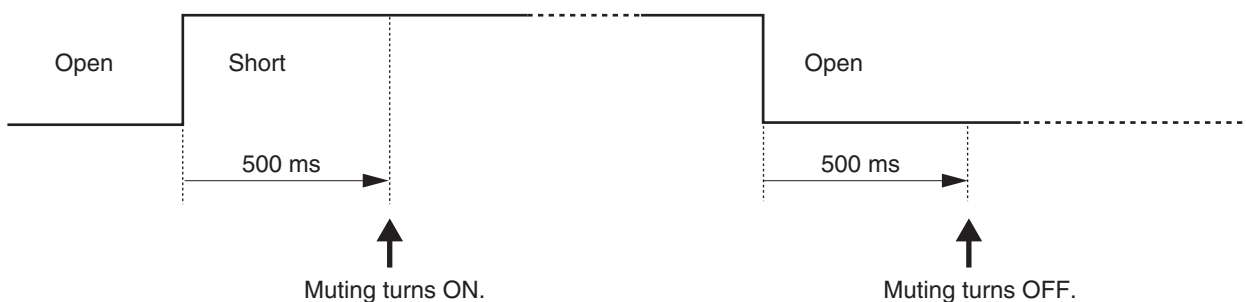

[Pulse operation]

Shorting each terminal with the C terminal turns muting ON. Muting turns OFF 500 ms after the terminals are opened and then shorted again. Muting toggles between ON and OFF as the short-open operation is repeated.

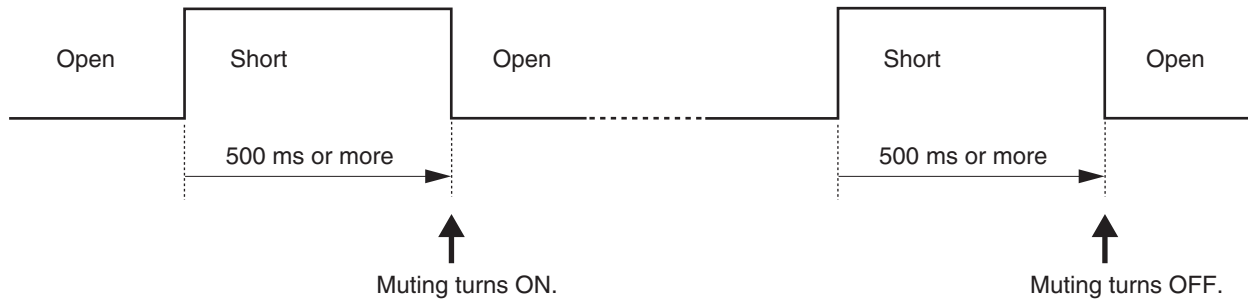

However, muting of the channel selected at 2 or more terminals is kept ON until all of the terminals that have selected the channel are turned OFF.

Example. CH1 and CH2 have been selected at Terminal 1, and CH1 and CH3 selected at Terminal 2

After turning muting ON for Ch1 and Ch2 at Terminal 1, if Terminal 2 is shorted, muting is turned ON for Ch1, Ch2, and Ch3. (Note that Ch1 muting is not turned OFF.*1)

If Terminal 1 is then short-circuited, Ch2 muting is turned OFF, however Ch1 muting is not turned OFF. (The reason is that Ch1 muting has been turned ON at Terminal 2.*2)

Next, if Terminal 2 is shorted, muting is turned OFF for Ch1 and Ch3.

	Short by Terminal 1	Short by Terminal 2	Short by Terminal 1	Short by Terminal 2
Ch1	Muting ON	Muting ON*1	Muting ON*2	Muting OFF
Ch2	Muting ON	Muting ON	Muting OFF	Muting OFF
Ch3	Muting OFF	Muting OFF	Muting ON	Muting OFF

8.13. Firmware Update

This section explains how to update the unit's firmware to conform with software upgrades.

Notes

- Save the unit's setting using the setting software before updating the firmware. Refer to the accompanying Software Instruction Manual for information about the setting software.
- The firmware cannot be updated if the Unit ID number is not correctly set. Because the Unit ID number is not factory-preset, set the correct Unit ID number referring to the Section "Unit ID Number Setting and Confirmation" on p. 16 of this manual.

8.13.1. Confirmation of connections

Update using the same connections as those which were used when setting the unit.

Step 1. Activate the setting software, then click on [File (F) → Open (O)] to open the setting file.

Step 2. Click on [Remote (R) → Connect] to confirm whether connections can be made normally.

Step 3. Click on [Remote (R) → Disconnect (D)] to terminate communications.

Step 4. Click on [File (F) → Exit (X)] to terminate the setting software.

8.13.2. Update program activation

Execute [Update DP-0206 Firmware] from the start menu.

Note

This program is also installed when the setting software is installed. Refer to the Software Instruction Manual for more information on setting software installation.

8.13.3. Update

There are 2 methods: one for RS-232C use and one for RS-485 use.

[Update using RS-232C]

Step 1. Press the Baud Rate Settings button to set the communication port. Be sure to set the communication speed to 115200 bps.

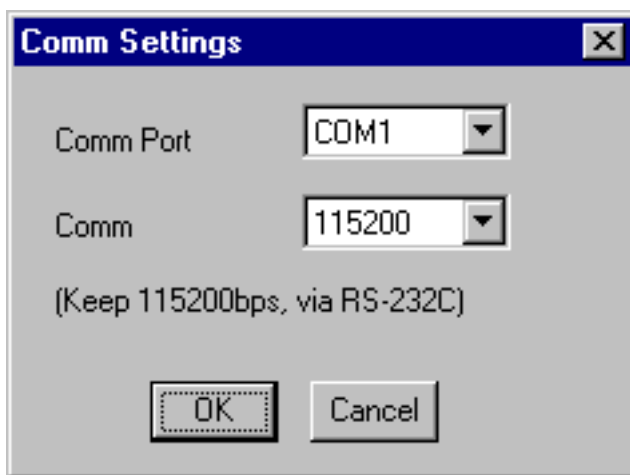

Step 2. Update begins when the Update button is pressed.

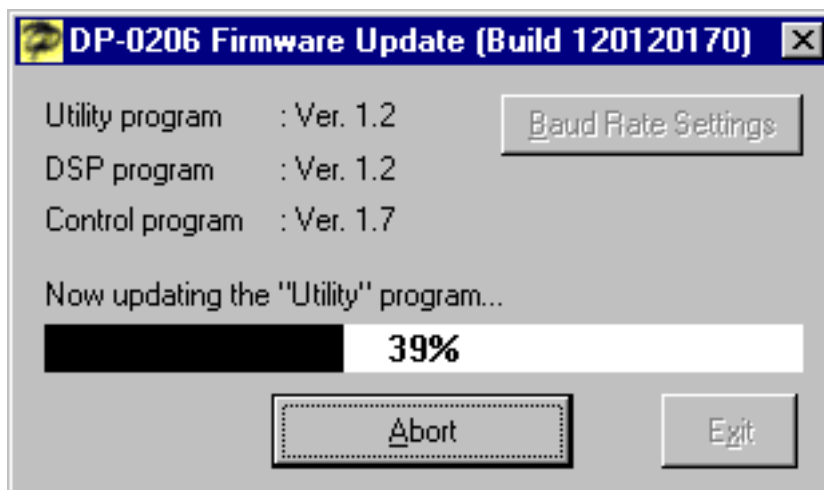

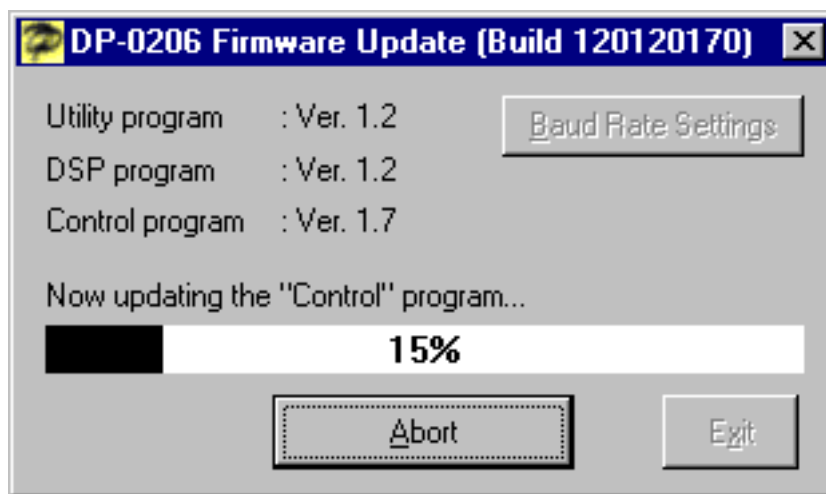
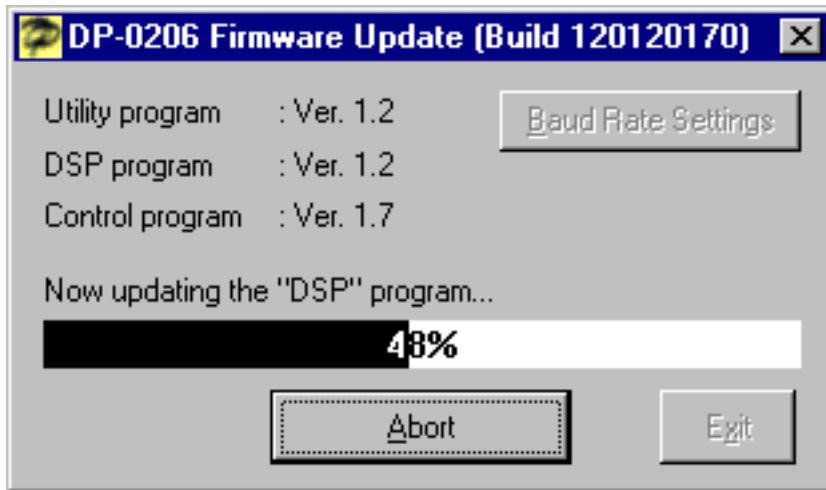

Step 3. The following message will be displayed upon update completion.

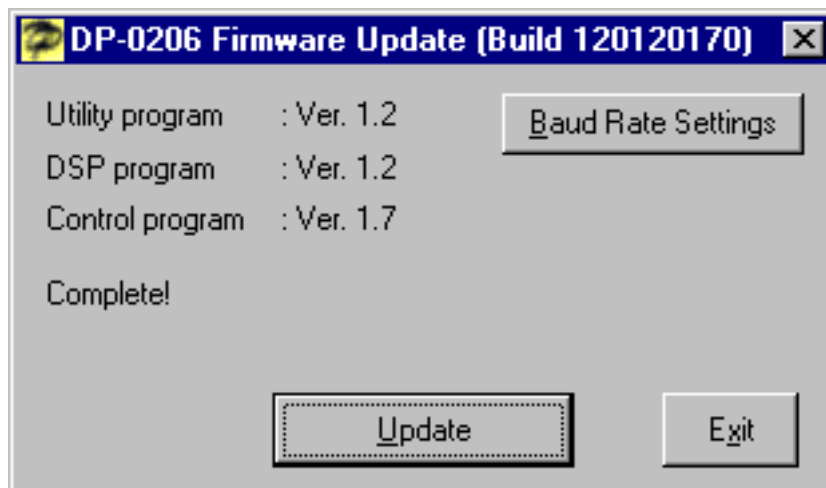

[Update using RS-485]

Step 1. Press the Baud Rate Settings button to set the communication port and transmission rate. Match the transmission rate with that set for the unit. (Refer to P. 23, Changing the RS-485 Communication Speed.)

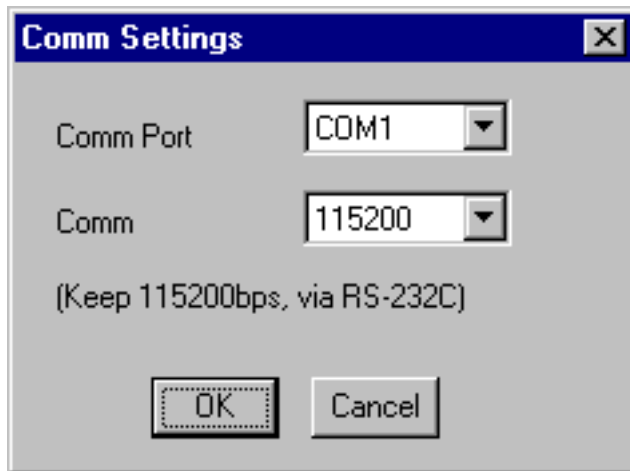

Step 2. Pressing the Update button (U) begins to update the transfer firmware.

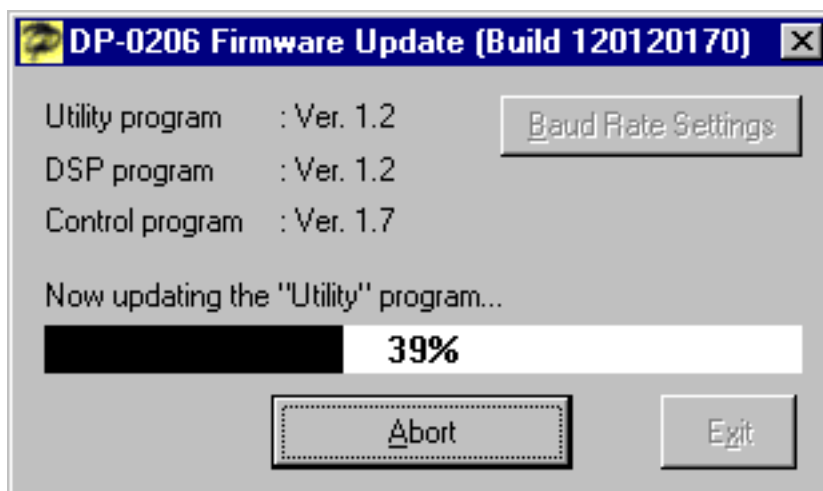

Step 3. The following message is displayed.

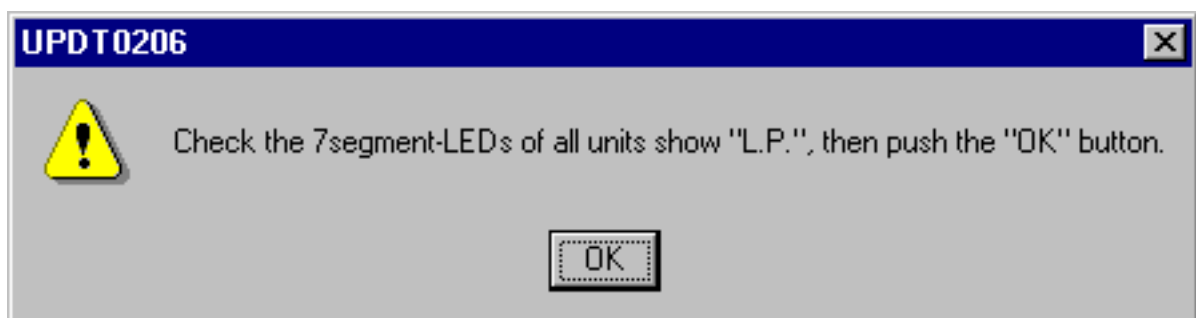

Step 4. Press the OK button as prompted by the message.
The signal processing firmware update is then started.

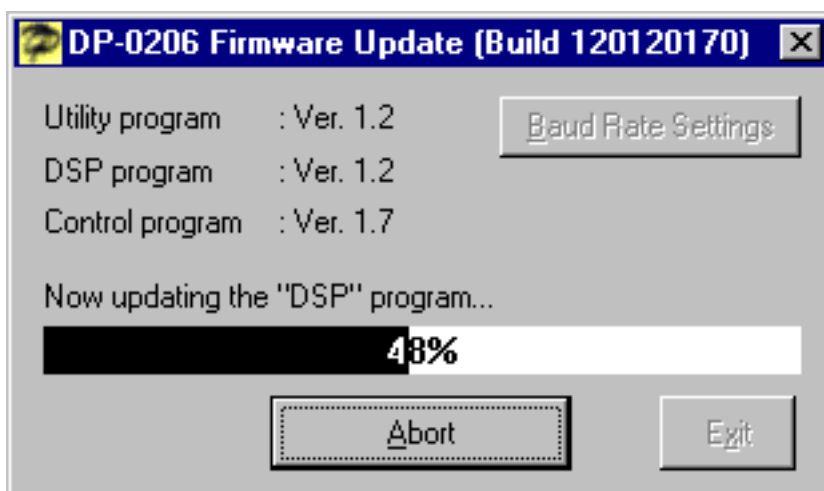

Step5. The following message is displayed.

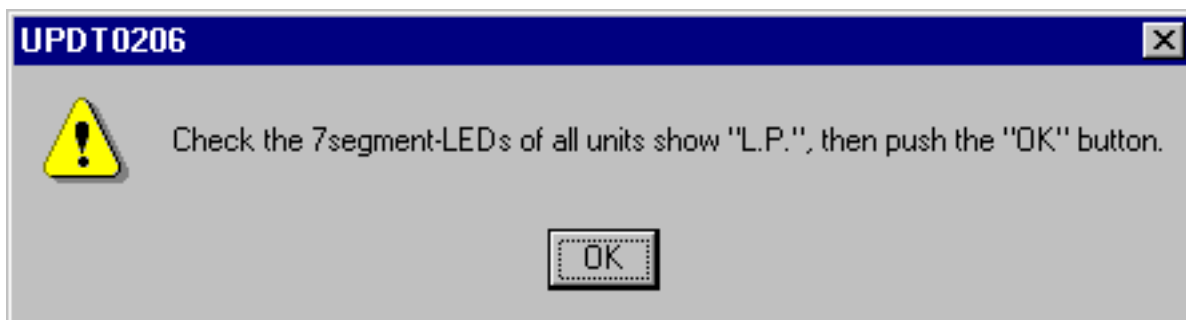

Step 6. Press the OK button as prompted by the message. The control firmware update is then started.

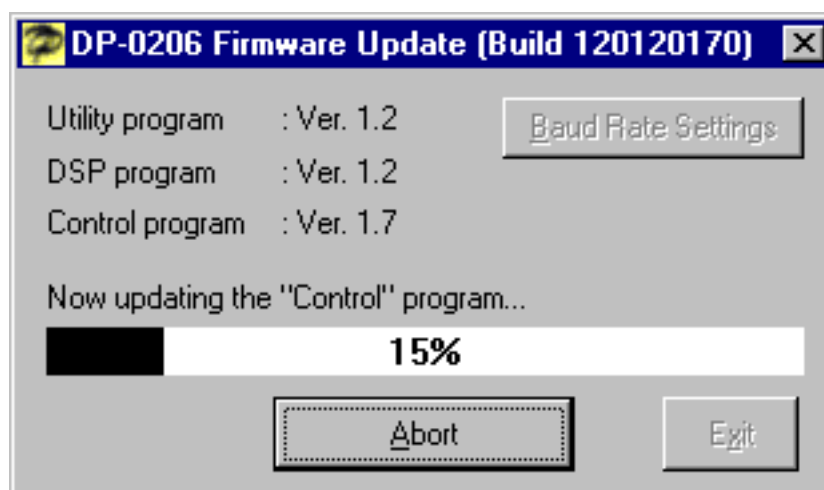

Step 7. The following message will be displayed upon update completion.



8.13.4. Setting restoration

Updating firmware may invalidate settings made before the update. In such cases, restore the settings using the following procedure:

Step 1. Delete all of the setting contents. (Refer to p. 22, Initialization.)

Step 2. Reset the Unit ID number. (Refer to p. 16, Unit ID Number Setting and Confirmation.)

Step 3. Activate the setting software and open the setting file.

Step 4. Click on [Remote (R) → Bulk transmission (T)].
When the transmission is finished, the settings will be restored.

8.14. Internal Memory Programming Precautions

Set data are stored in the unit's internal memory. The decimal point of the first digit on the Memory/Unit ID Number display flashes while programming data into the internal memory. Data may be lost if the unit's power is switched off or the Reset button is pressed during this operation.

Avoid switching off the unit's power or pressing the Reset button while the first digit decimal point on the Memory/Unit ID Number display is flashing.

Care does not need to be taken during normal operation. However, when a large volume of set data is being transmitted from a PC through bulk transmission, the process of writing into internal memory continues for approximately 1 minute. Therefore, do not switch off the power or press the Reset button during this duration.

8.15. Memory/Unit ID Number Display Indication at Activation

The Memory/Unit ID Number Display's indication changes in the following order after the power has been switched on or the Reset button pressed.

(1) "8.8." (All indicators ON)



(2) "dP"



(3) "CH", "C1", "C2" or "C3"
(Refer to p.23, RS-485 Communication Speed.)

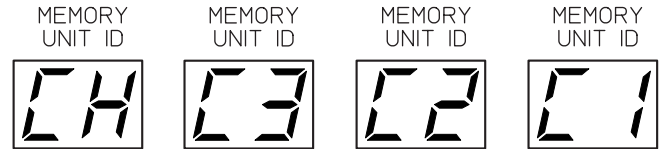

(4) "1.7", etc. (Firmware's version number)



(5) "16", etc. (Current pattern memory)



Notes

- When no Unit ID number is set, the "Id" indication flashes in (5).

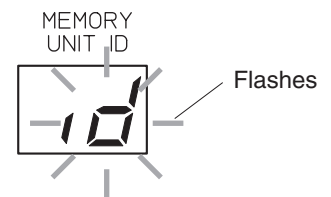

- When the RS-232C communication port is set to permit the connection of the DK-1608 Memory Selector (refer to p. 24, Recalling Pattern Memory Using the Memory Selector), the "oP" indication is displayed between (4) and (5).



8.16. Connection Example

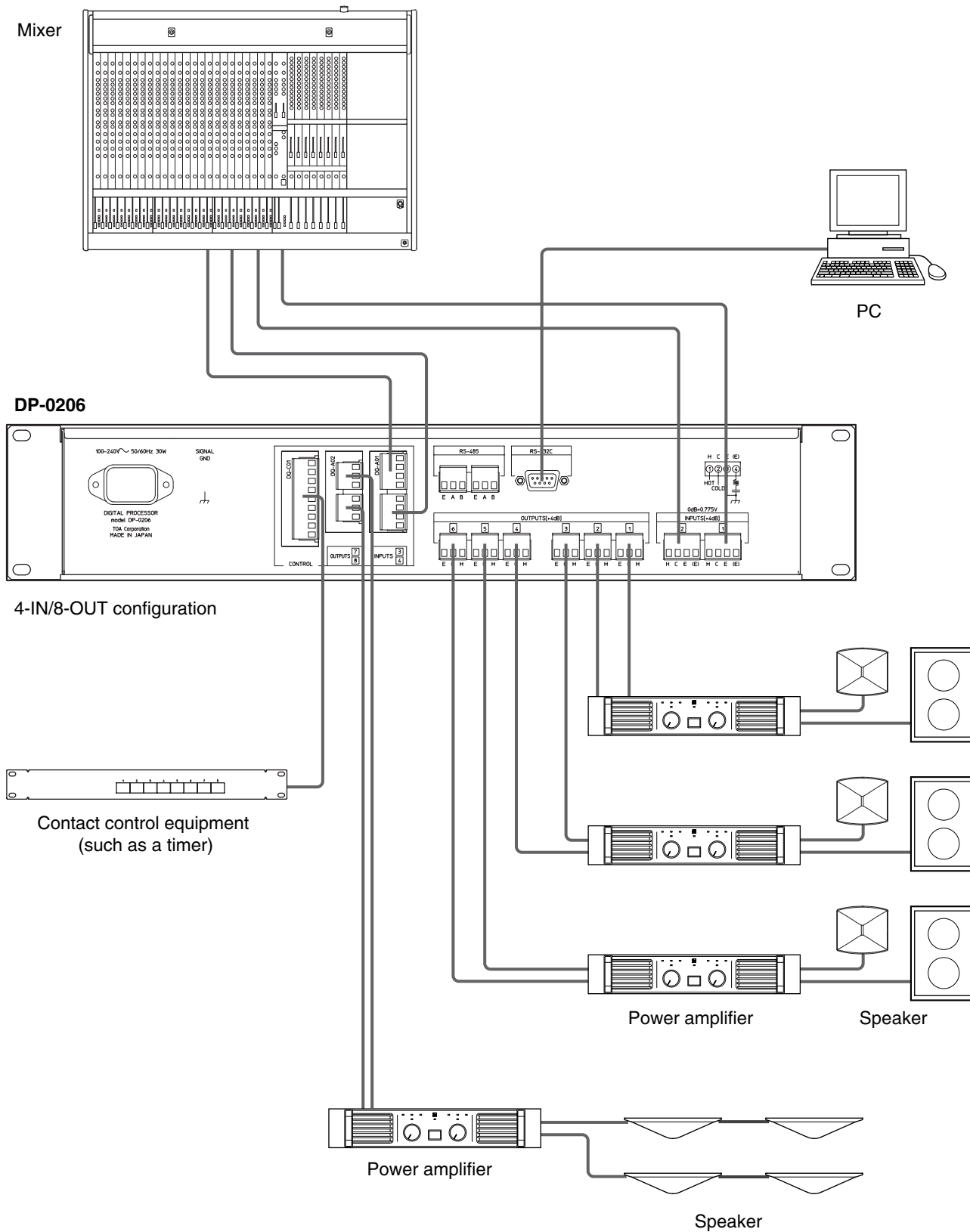

9. BLOCK DIAGRAM

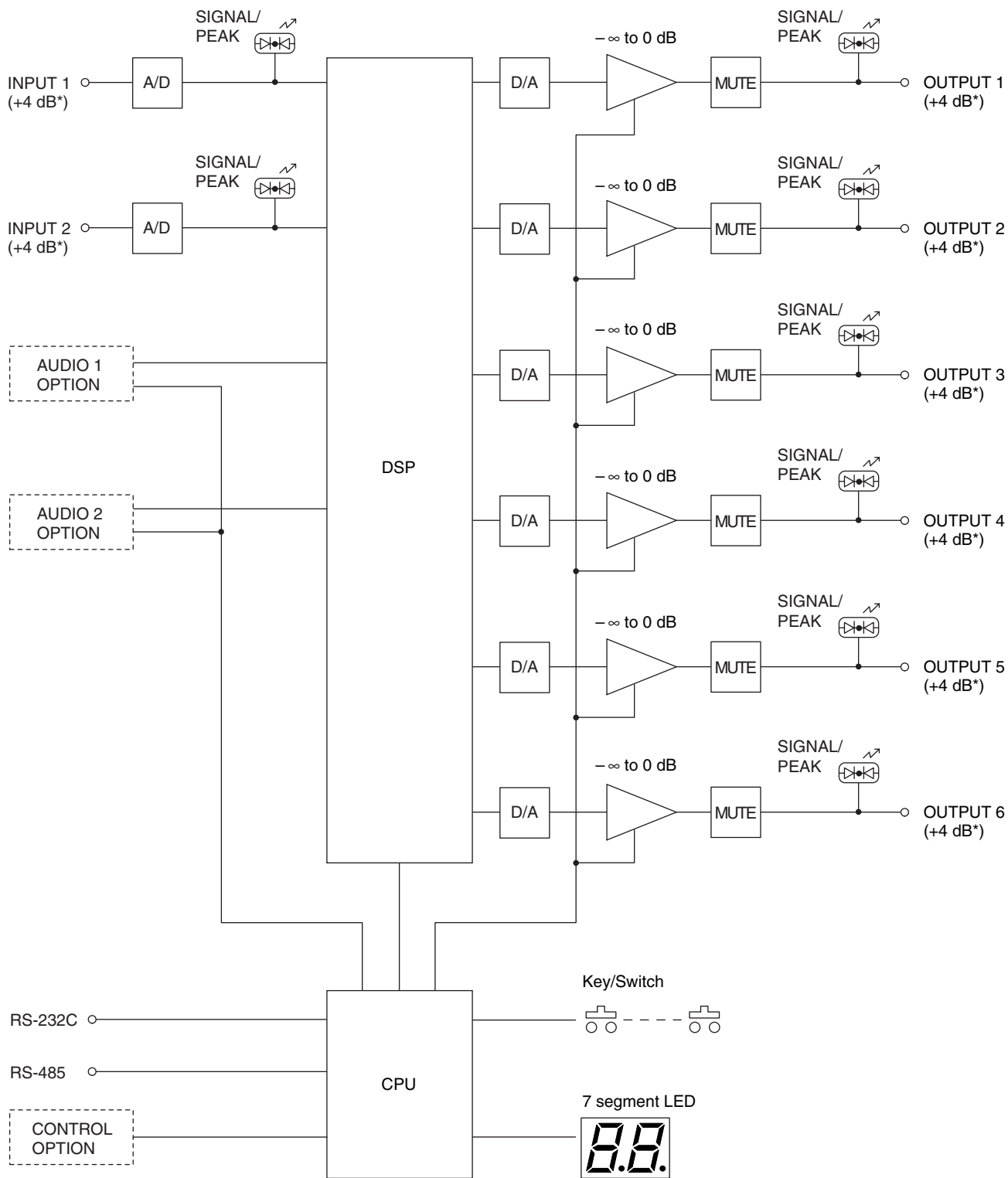

* 0 dB = 0.775 V

10. SPECIFICATIONS

Power Source	100 – 240 V AC, 50/60 Hz	
Power Consumption	30 W	
Frequency Response	20 – 20,000 Hz (± 1 dB)	
Sampling Frequency	48 kHz	
Dynamic Range	110 dB (IHF-A weighted)	
Total Harmonic Distortion	Less than 0.05%, 1 kHz, +4 dB* input/output (20 – 20,000 Hz BPF)	
Input	2 channels (expandable to up to 6 channels), +4 dB* (Max. +24 dB*), 10 k Ω , electronically-balanced, terminal block type connector (4 poles)	
Output	6 channels (expandable to up to 10 channels), +4 dB* (Max. +24 dB*), adaptable load of over 600 Ω , electronically-balanced, terminal block type connector (3 poles)	
A/D Converter	24 bits	
D/A Converter	24 bits	
Level Control	+12 to $-\infty$ dB (phase can be reversed.)	
Signal Processing	Equalizer/Filter	Graphic equalizer: 1/3 octave band, 31 center frequencies (10 points adjustable), ± 12 dB, Q:0.267 – 69.249, each band independently variable Parametric equalizer: Frequency continuously variable type (20 – 20,000 Hz), 10 bands, ± 12 dB, Q:0.267 – 69.249 Filtering: High-pass filter 20 – 20,000 Hz, 12 dB/oct, 6 dB/oct Low-pass filter 20 – 20,000 Hz, 12 dB/oct, 6 dB/oct Notch filter 20 – 20,000 Hz, Q:8.561 – 69.249 Parametric filter 20 – 20,000 Hz, ± 12 dB, Q:0.267 – 69.249 All-pass filter 20 – 20,000 Hz, Q:0.267 – 69.249 High frequency boost/cut 6 – 20 kHz, ± 12 dB Low frequency boost/cut 20 – 500 Hz, ± 12 dB Horn equalizer 20 kHz, 0 to +18 dB
	Compressor	Threshold: -16 to +24 dB* Ratio: 1:1 – ∞ :1 Attack time: 0.02 – 100 ms Release time: 10 ms – 5 s
	Noise Gate	Threshold: $-\infty$ to -26 dB* Attack time: 0.1 – 100 ms Release time: 20 ms – 5 s
	Delay	Delay time: 0 – 682 ms
	Matrix	2 x 6 (Expanded I/O configuration: 2 x 8, 2 x 10, 4 x 6, 4 x 8, 6 x 6) Level control: 0 to $-\infty$ dB (phase can be reversed.)
	Channel Divider	2-way, 3-way, 4-way Crossover frequency: 20 – 20,000 Hz (overlap mode) Slope: 6 dB/oct, 12 dB/oct, 18 dB/oct, 24 dB/oct Level: +12 dB to $-\infty$ dB (phase can be reversed.) Delay: 0 – 682 ms
	Muting	Output muting
Memory	16 pattern memories	
Auxiliary Function	System Lock function	
Control	Control software: PC software (Windows 95/98/NT compatible) Control system: RS-232C D-sub connector (9 pins) RS-485 Terminal block type 3-pole connector, Max. 30 units can be controlled. Remote Control Module DQ-C01 (optional): Pattern memory selection, output volume adjustment, external output muting control	
Panel	Memory Recall key: 16 memories Unit ID Number Display key: 30 units Input level indicator: 6 channels, dual-color LED Output level indicator: 10 channels, dual-color LED Memory/Unit ID Number display: Double-digit, 7-segment LED Master indicator: Green LED	

Finish	Panel: Aluminum, hair-line finish, black Other sections: Pre-coated steel plate, black, 30% glossy
Dimensions	482 (w) x 88.4 (h) x 331.1 (d) mm
Weight	4.65 kg

Notes

* 0 dB = 0.775 V

- Windows 95/98/NT are Microsoft Corporation's trademarks.
- The design and specifications are subject to change without notice for improvement.

• Accessories

Power cord	1
Fuse	1
Rack mounting screw	4

[Analog Input Module DQ-A01/Analog Output Module DQ-A02] (optional product)

Model No.	DQ-A01	DQ-A02
Input	2 channels, +4 dB* (Max. +24 dB*), 10 kΩ, electronically-balanced, terminal block type connector (4 poles)	—
Output	—	2 channels, +4 dB* (Max. +24 dB*), adaptable load of over 600 Ω, electronically-balanced, terminal block type connector (3 poles)
A/D Converter	24 bits	—
D/A Converter	—	24 bits
Sampling Frequency	48 kHz	
Frequency Response	20 – 20,000 Hz (±1 dB)	
Dynamic Range	110 dB (IHF-A weighted)	
Total Harmonic Distortion	Less than 0.05%, 1 kHz, +4 dB* input/output (20 – 20,000 Hz, BPF)	
Finish	Pre-coated steel plate, black, 30% glossy	
Dimensions	25.6 (w) x 76.5 (h) x 168 (d) mm	
Weight	80 g	100 g

Note: The design and specifications are subject to change without notice for improvement.

* 0 dB = 0.775 V

• Accessories

DP-0206 mounting screw	2
Terminal block type connector	2
I/O number seal	2

[Remote Control Module DQ-C01] (optional product)

Control Input		COM/terminal 1 – 8: Open voltage: 5 V DC, short-circuit current: 25 mA, terminal block type connector (9 poles)
Control	Memory Selection	Direct: Max. 8 memories, Binary: Max. 16 memories (Any one of 16 memories assignable to each terminal in "Direct" mode.) Control method: No-voltage make of over 500 ms/No-voltage make pulse of over 500 ms ("No-voltage make of over 500 ms" only in "Binary" mode.)
	Volume Adjustment (Up/Down)	Direct: Max. 4 groups, Binary: Max. 10 groups (Any output channel or channel group assignable to each terminal) Control method: 1 step up/down variation with no-voltage make pulse of over 500 ms. Continuous 1-step variation in 500 ms units with pulse of over 700 ms. Variation stops with a break pulse. Variable range: 0 to $-\infty$ dB
	Muting (ON/OFF)	Max. 8 groups (Any output channel or channel group assignable to each terminal) Control method: No-voltage make of over 500 ms/No-voltage make pulse of over 500 ms
The above controls can be performed singly or in combination with other controls.		
Setting		PC software (Windows 95/98/NT compatible)
Finish		Pre-coated steel plate, black, 30% glossy
Dimensions		25.6 (w) x 76.5 (h) x101 (d) mm
Weight		60 g

Notes

- Windows 95/98/NT are Microsoft Corporation's trademarks.
- The design and specifications are subject to change without notice for improvement.

• Accessories

- DP-0206 mounting screw 2
- Terminal block type connector 1