

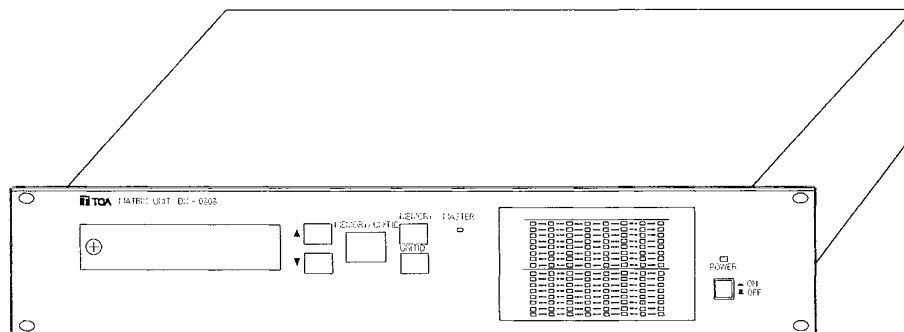

**MATRIX UNIT**
**DX-0808**

	<b>CAUTION</b> RISK OF ELECTRIC SHOCK DO NOT OPEN	
<b>CAUTION</b>		
TO REDUCE THE RISK OF ELECTRICAL SHOCK, DO NOT REMOVE COVER. NO USER SERVICEABLE PARTS INSIDE. REFER SERVICING TO QUALIFIED SERVICE PERSONNEL		



THE LIGHTNING FLASH WITH ARROWHEAD WITHIN A TRIANGLE IS INTENDED TO TELL THE USER THAT PARTS INSIDE THE PRODUCT ARE A RISK OF ELECTRIC SHOCK TO PERSONS.



THE EXCLAMATION POINT WITHIN A TRIANGLE IS INTENDED TO TELL THE USER THAT IMPORTANT OPERATING AND SERVICING INSTRUCTIONS ARE IN THE PAPERS WITH THE APPLIANCE.

**CONTENTS**

<b>1. GENERAL DESCRIPTION</b> ..... 2 <b>2. FEATURES</b> ..... 2 <b>3. HANDLING PRECAUTIONS</b> ..... 2 <b>4. SIGNAL PROCESSING FUNCTION</b> ..... 2 <b>5. NOMENCLATURE AND FUNCTIONS</b> ..... 3 [FRONT PANEL] ..... 3 [FRONT POCKET] ..... 4 [REAR PANEL] ..... 5 <b>6. PERSONAL COMPUTER CONNECTIONS</b> ..... 6	<b>7. UNIT ID NUMBER SETTING</b> ..... 8 <b>8. USING THE MEMORY I/O CONNECTOR</b> ..... 9 <b>9. EXPANSION AND INTERNAL SWITCH SETTING</b> ..... 10 <b>10. RECALLING THE PATTERN MEMORIES</b> ..... 11 <b>11. SPECIFICATIONS</b> ..... 11 <b>12. APPEARANCE</b> ..... 12
---	--

Please follow the instructions in this manual to obtain the optimum results from this unit. We also recommend that you keep this manual handy for future reference.

## 1. GENERAL DESCRIPTION

A 2-unit size, digitally-controlled analog matrix unit, the TOA DX-0808 is equipped with 8 inputs, 8 buses, and 8 outputs. Using dedicated software operating on a personal computer, an operator can set each function in detail. The settings can be stored in the component's internal memory, and the memory can be recalled from the component even when not connected to a personal computer.

## 2. FEATURES

- Free zone selection and level adjustment from PC.
- Up to 16 setting patterns can be stored, which can be easily recalled even without connecting to a personal computer.
- The stored information can be remotely recalled from external equipment, and the memory selection status can be output.
- Expandable input and output because of eight-bus construction.
- RS-485 ports control up to 30 units.
- A 3-step system locking function prevents problems resulting from operator error.
- Wide operating voltage range : 90 VAC - 250 VAC.

## 3. HANDLING PRECAUTIONS

- The matrix unit has no parameter setting functions, so you use a personal computer and the dedicated TOA software program to set the parameters.
- Turn the power switch ON only after all terminals and other wires are connected.
- Avoid installing the unit near a heater or exposing it to direct sunlight as this may damage the unit. Also, do not install the unit in humid or dusty locations.
- Do not jolt or vibrate the DX-0808 as it is a precision instrument.
- Never attempt to service the unit yourself as opening or moving the covers may expose you to dangerous voltage or other hazards. Refer all servicing to TOA dealers.

## 4. SIGNAL PROCESSING FUNCTION

The DX-0808 is a digitally-controlled matrix unit.

All parameter setting functions and setting value ranges are, therefore, accomplished by operating the personal computer software. Refer to the software specifications for details of the functions.

## 5. NOMENCLATURE AND FUNCTIONS

### [FRONT PANEL]

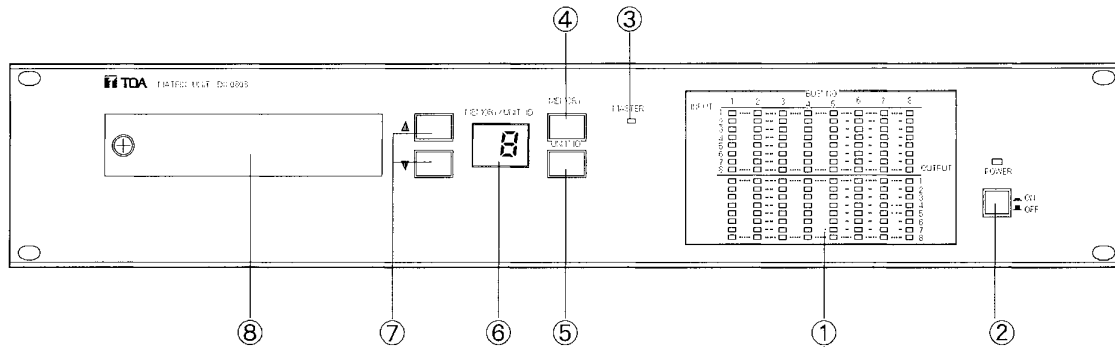

#### ① Status indicator LED

This indicator provides a matrix display of the input-to-bus assignment status and output selection status.

#### ② Power switch [ ON, OFF ]

Set this switch to ON and the processor starts operating in the status it was in just before the power was last turned OFF. The power LED lamp lights at this time.

#### ③ Master unit indicator [MASTER]

The unit in which the ID number is set to "1" (LED lamp lights) functions as a master unit when switching between stored information. For details, refer to p. 8. "7. UNIT ID NUMBER SETTING".

#### ④ Memory call key [MEMORY]

This key is used to recall the memory pattern selected with the memory/unit number selection key.

#### ⑤ Unit ID number indication key [UNIT ID]

This key is used to show the unit ID number on the display.

#### ⑥ Memory/unit ID number display [MEMORY/UNIT ID]

Either the memory number or unit ID number is displayed. Usually, the selected memory number is displayed.

#### ⑦ Memory/unit ID number selection key [ , ]

The memory number or unit ID number can be selected with the UP and DOWN keys.

#### ⑧ Pocket cover

## [FRONT POCKET]

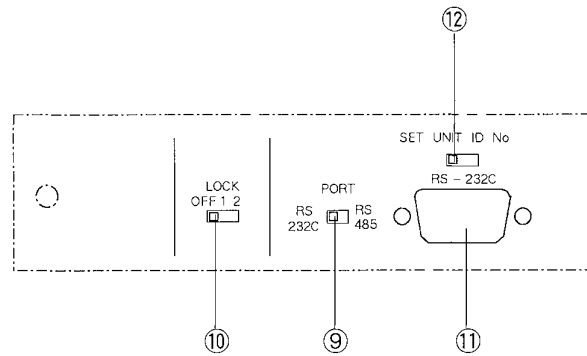

### ⑨ Communications port selection switch [PORT]

This switch is used to select the communications port your computer is connected to. RS-232C is valid only when controlling a single unit, and the front- or rear-mounted D-SUB connector can be used. Use RS-485 when controlling multiple units. XLR connectors for RS-485 are mounted on the back of the unit.

### ⑩ System locking switch [LOCK]

Use this switch to set how the hardware is locked.

OFF : All functions are available (unlocked), such as memory switching.

1 : All functions are locked except memory switching.

2 : All front panel facilities are locked.

**Note** Make sure the power is switched ON when you use this switch.

### ⑪ RS-232C communications port [RS-232C]

This is a 9-pin D-SUB connector for RS-232C communications, and can only be used when the communications port selection switch is set to "RS-232C". This port is connected in parallel to the rear-mounted D-SUB connector for RS-232C. For details, refer to p.6 "6. PERSONAL COMPUTER CONNECTIONS".

### ⑫ Unit ID number setting key [SET UNIT ID No.]

Use this key to set the unit ID number. For details, refer to p.8 "8.UNIT ID NUMBER SETTING".

## [REAR PANEL]

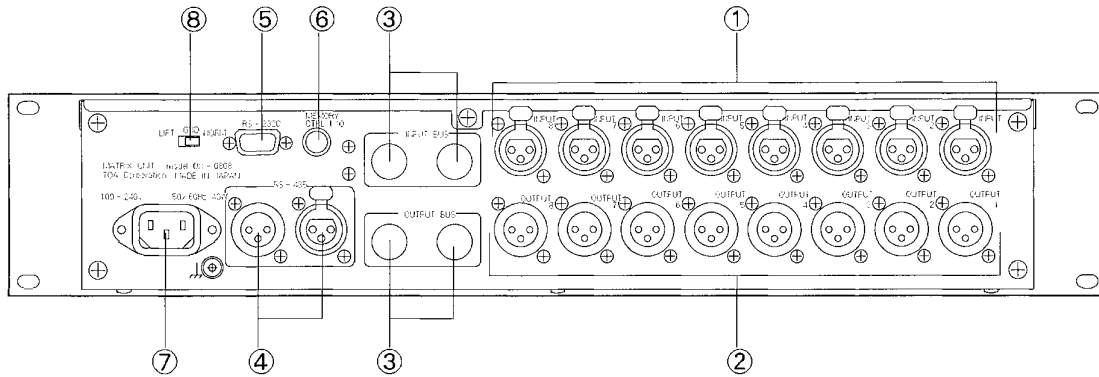

- ① **Input connector [INPUT 1,2, ..... 8]**  
An electronically-balanced XLR connector.
- ② **Output connector [OUTPUT 1,2, ..... 8]**  
An electronically-balanced XLR connector.
- ③ **Input bus connector [INPUT BUS] /Output bus connector [OUTPUT BUS]**  
These connectors are used to expand the input and output. When expanding, the corresponding unit's internal switch must be set. For details, refer to p.10 "10. EXPANSION AND INTERNAL SWITCH SETTING".
- ④ **RS-485 communications port [RS-485]**  
A 3-pin XLR connector for RS-485 communications. This connector can only be used when the communications port selection switch located in the front pocket is set to "RS-485". When simultaneously controlling two or more units, use this port and connect each unit in turn. A mode conversion adaptor is required because data are usually transmitted from a personal computer in RS-232C mode. For details, refer to p.6 "6. PERSONAL COMPUTER CONNECTIONS".
- ⑤ **RS-232C communications port [RS-232C]**  
A 9-pin D-SUB connector for RS-232C communications. This connector can only be used when the communications port selection switch located in the front pocket is set to "RS-232C". This connector is connected in parallel to the D-SUB connector for RS-232C in the pocket, and is valid only when controlling a single unit. For details, refer to p.6 "6. PERSONAL COMPUTER CONNECTIONS".
- ⑥ **Memory I/O connector [MEMORY CTRL I/O]**  
This connector allows external remote pattern memory control, as well as output of memory selection status to external equipment. Remote control is accomplished by make contact, and the 5 V logic output is used for external output. For details, refer to p.9 "8. USING THE MEMORY I/O CONNECTOR".
- ⑦ **Power inlet**  
Connect the power cord included with the unit to this inlet.
- ⑧ **Ground loop break switch [GND]**  
This switch, when set to "LIFT" position, breaks a hum-generating ground loop formed when the unit is connected to external components. Normally, set this switch to "NORM" position.

## 6. PERSONAL COMPUTER CONNECTIONS

The DX-0808 has no built-in parameter setting function. You need to use the dedicated TOA software operating on a personal computer to set the parameters.

There are two connection (communications) methods; RS-232C and RS-485 communications.

Use either communications method depending on the system configurations exemplified below.

- (1) When setting parameters of a single unit, connect to the RS-232C connector.
- (2) When setting parameters of more than one unit, connect to the RS-485 connector.
- (3) When setting parameters in the system employing this unit and the DP-0202 or DP-0204 digital processor, connect the RS-485 connector.

### (1) When setting parameters of only one unit

In this case, use the communications method called "RS-232C". Set the communications port selection switch in the front pocket to "RS-232C". As shown in Fig. 1, connect a straight cable from the PC's RS-232C port to the DX-0808's connector for RS-232C communications. Either the connector in the front pocket or on the rear panel may be used: both are 9-pin D-SUB connectors and are connected in parallel. Below are RS-232C's control specifications:

Baud rate : 9,600 bps  
Parity : None  
Data : 8 bits  
Stop bits : 1 bit

Although RS-232C is a one-to-one communications method, the maximum transmission distance is 10 m. If the distance exceeds 10m, we recommend connecting your unit to the PC using an RS-485, even if using only one unit. In addition, because the setting status is stored in the unit's memory, set patterns can still be used even with a personal computer disconnected.

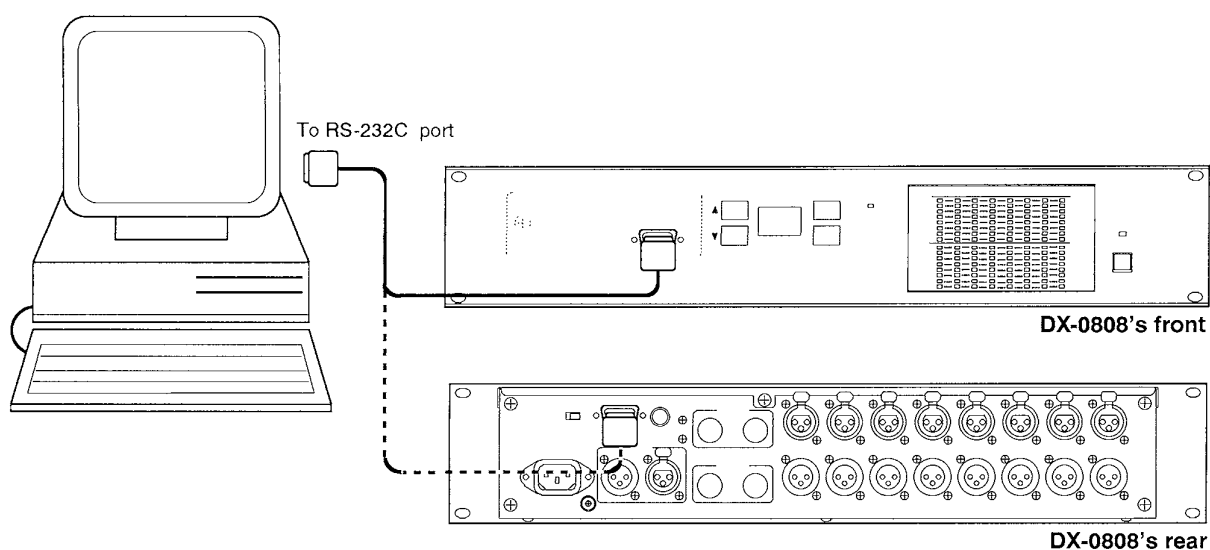

Fig. 1 RS-232C port connection between a PC and a single unit.

**(2) When setting parameters of more than one unit**

In this case, use the communications method called "RS-485". Because multiple units are controlled, each unit needs its own unique ID registered in advance. For details, refer to p.8 "8. UNIT ID NUMBER SETTING". Set the communications port selection switch in the front pocket to "RS-485". Connection between a personal computer and each unit is shown in Fig. 2.

Personal computers normally have only an RS-232C port, and thus require an adaptor to convert the RS-232C port to an RS-485 port.

Connect the PC's RS-232C port to the DX-0808's female connector for RS-485 communications via the adaptor. Similarly, make connections for the second unit and its subsequent units as shown in Fig. 2. Since the settings made through the PC can be stored in each unit's memory, the set patterns can be recalled if only units are connected as shown in Fig. 2'; the adaptor and computer are not necessary to recall the patterns. In this case, the unit with ID No. 1 acts as a master unit to control the other units.

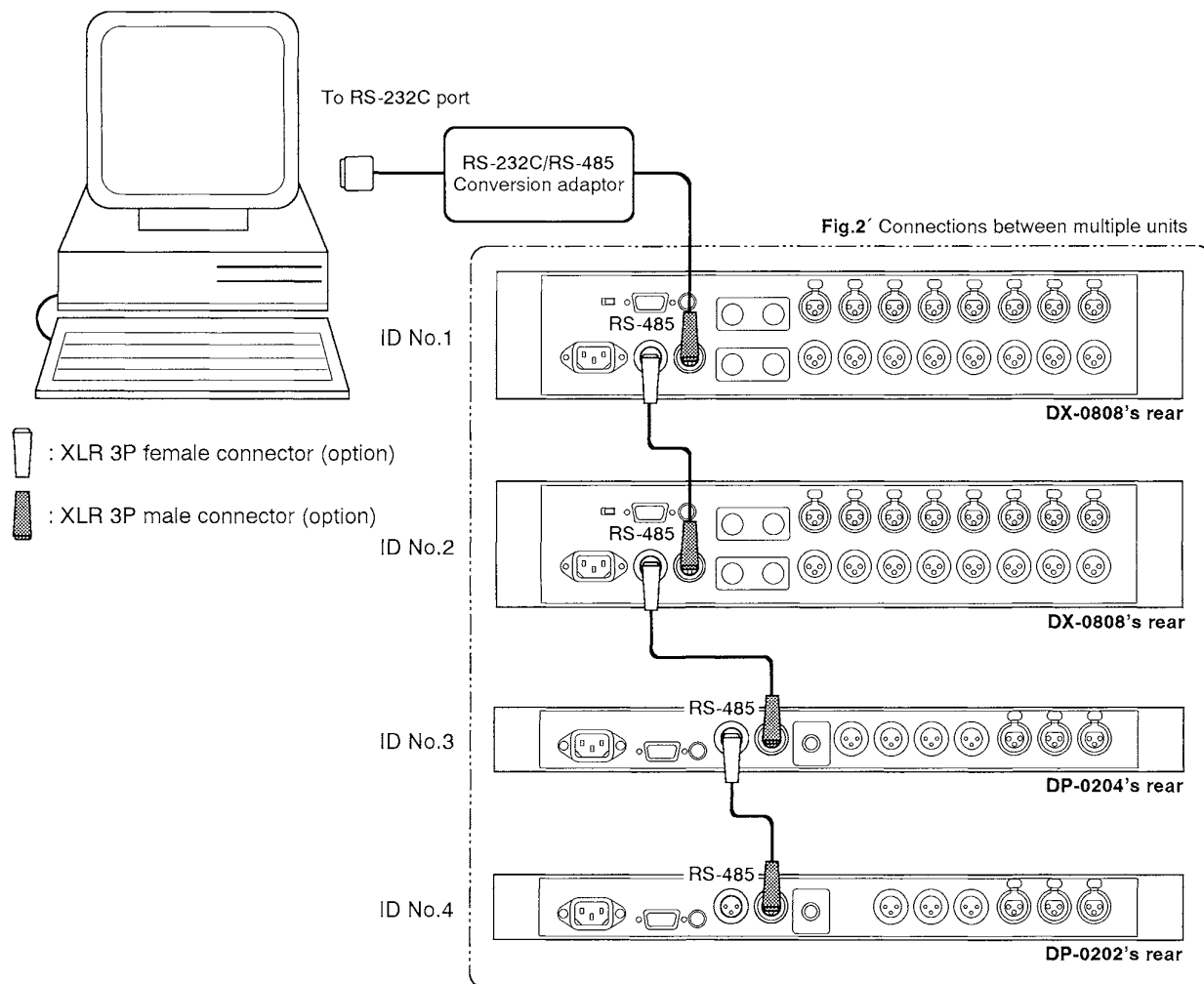

**Fig.2 Communications port connections between a PC and multiple units**

**(3) When using the DX-0808 in conjunction with the DP-0202 or DP-0204 digital processor**

Parameters can be set and controlled from one PC in the same manner and connections as described in Item (2) above.

## 7. UNIT ID NUMBER SETTING

To control two or more units, give each unit a separate number called a unit ID number, then send the setting data from a personal computer. The ID numbers must be consecutive from No. 1 to No. 30, and be set in advance.

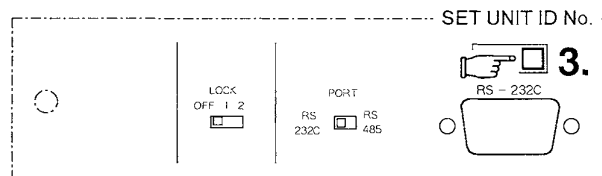
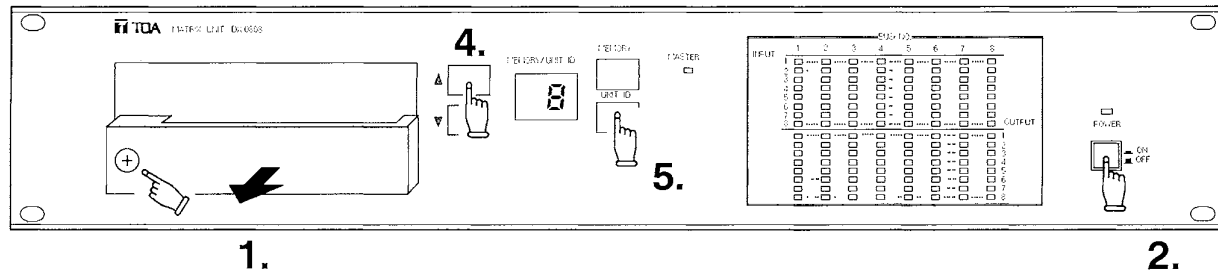

### ● Setting the number

1. Open the front pocket.
2. Switch on the power.
3. Hold the lever of the unit ID number setting switch to the right.
4. While holding the lever, operate the front-mounted memory/unit number selection key to show the desired number on the memory/unit number display.
5. Push the unit ID number indication key to register the number being displayed.
6. Release the unit ID number setting switch.

### Notes

- The ID number is factory preset to No. 1.
- Make sure the same number is not registered twice.
- To confirm the set number, press the unit ID number display key located on the front panel.



## 8. USING THE MEMORY I/O CONNECTOR

The memory I/O connector allows remote control of 16 pattern memories from external equipment, as well as output of the memory selection status to external equipment. The I/O controls are performed in 4 bits. Remote operations can be controlled using a make contact, and a 5V logic output is used to output information to external equipment. By using this terminal, stored information can be remotely recalled or control signals can be sent to other equipment.

### 8.1 Remote memory call

Keeping the level of pin No. 2 low enables external remote memory control. Table 1 shows the relationship of each pin's input status to memory number. Set patterns can be recalled through a simple diode matrix.

#### Note

No connection is possible for the pins in "H" status shown in Table 1. (These pins are pulled up at 5V.)

### 8.2 Memory selection status output

The memory selection status can be output to external equipment by making the connector's pin No. 2 a high level. Table 2 shows the relationship of selected memory to each pin's output status.

#### Note

No connection is possible for the pin 2 (CTRL input) shown in Table 2. (This pin is pulled up at 5V.)

- Pin arrangement of the memory I/O connector

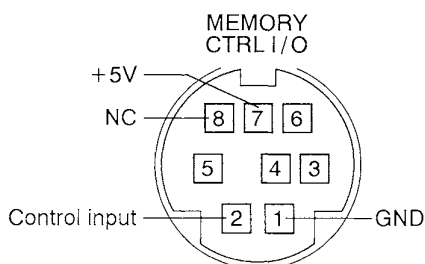

**Table 1** Pin's input status VS. memory number

	PIN 2 CTRL IN	PIN 6 IN	PIN 5 IN	PIN 4 IN	PIN 3 IN
Memory No. 1	L	L	L	L	L
Memory No. 2	L	L	L	L	H
Memory No. 3	L	L	L	H	L
Memory No. 4	L	L	L	H	H
Memory No. 5	L	L	H	L	L
Memory No. 6	L	L	H	L	H
Memory No. 7	L	L	H	H	L
Memory No. 8	L	L	H	H	H
Memory No. 9	L	H	L	L	L
Memory No.10	L	H	L	L	H
Memory No.11	L	H	L	H	L
Memory No.12	L	H	L	H	H
Memory No.13	L	H	H	L	L
Memory No.14	L	H	H	L	H
Memory No.15	L	H	H	H	L
Memory No.16	L	H	H	H	H

**Table 2** Selected memory VS. pin's output status

	PIN 2 CTRL IN	PIN 6 OUT	PIN 5 OUT	PIN 4 OUT	PIN 3 OUT
Memory No. 1	H	L	L	L	L
Memory No. 2	H	L	L	L	H
Memory No. 3	H	L	L	H	L
Memory No. 4	H	L	L	H	H
Memory No. 5	H	L	H	L	L
Memory No. 6	H	L	H	L	H
Memory No. 7	H	L	H	H	L
Memory No. 8	H	L	H	H	H
Memory No. 9	H	H	L	L	L
Memory No.10	H	H	L	L	H
Memory No.11	H	H	L	H	L
Memory No.12	H	H	L	H	H
Memory No.13	H	H	H	L	L
Memory No.14	H	H	H	L	H
Memory No.15	H	H	H	H	L
Memory No.16	H	H	H	H	H

## 9. EXPANSION AND INTERNAL SWITCH SETTING

### [CAUTION]

THESE SERVICING INSTRUCTIONS ARE FOR USE BY QUALIFIED PERSONNEL ONLY. TO AVOID ELECTRIC SHOCK DO NOT PERFORM ANY SERVICING OTHER THAN THAT CONTAINED IN THE OPERATING INSTRUCTIONS UNLESS YOU ARE QUALIFIED TO DO SO. REFER ALL SERVICING TO QUALIFIED SERVICE PERSONNEL.

With an 8-bus matrix unit, the DX-0808 can be expanded by expanding its I/O buses. Use 8-pin DIN connectors for bus connection, as shown in Fig. 3. Also, the internal switch of the unit to be expanded needs to be set. Set all internal DIP switches (SW-101, SW-102, and SW-103) to OFF, as shown in Fig. 4.

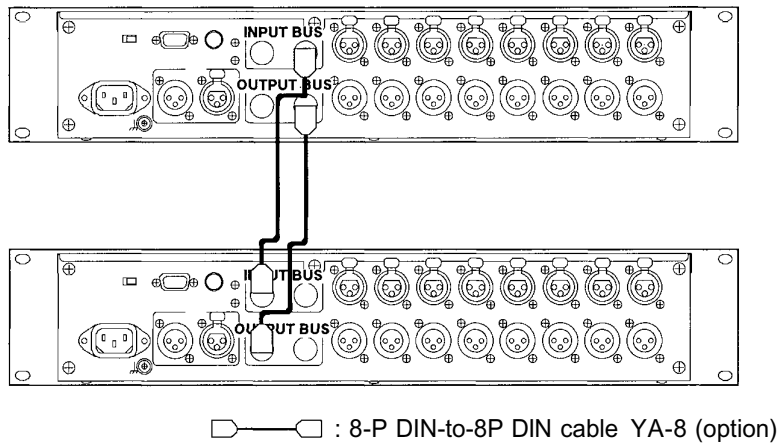

**Fig.3 Bus connection for expansion**

Expanded unit

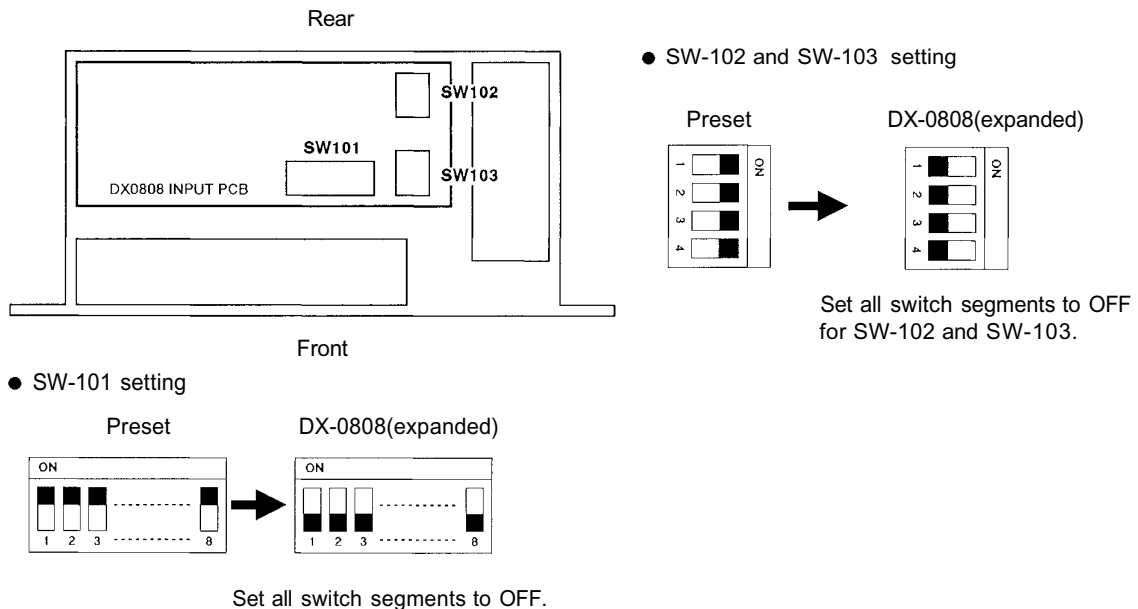

**Fig.4 Internal DIP switch settings for the expanded unit**

## 10. RECALLING THE PATTERN MEMORIES

Although storing the set parameters into up to 16 memories of the DX-0808 needs the dedicated TOA software and a personal computer, recalling them can be performed without using the software and computer.

When multiple are connected through RS-485 communications ports as shown in Fig. 2 on page 7 the units, with ID No. 1 acts as a master unit to recall the same pattern memory of all connected units.

Follow the procedures below to recall pattern memories when the DX-0808 is a master unit.

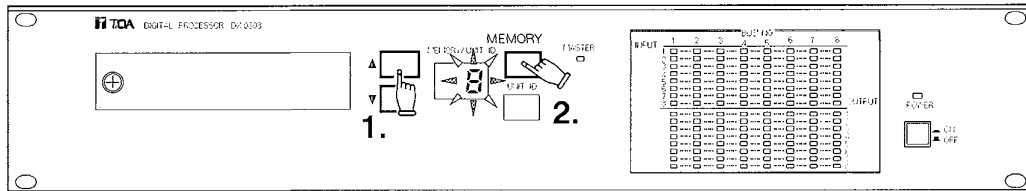

1. Push the front-mounted memory/unit number selection key to show the desired memory number on the display. (The displayed number will flash.)

2. Push the memory recall key to recall the selected pattern memory. (The display stops flashing.)

The memory recall can be performed remotely by a personal computer or by external equipment connected through the rear-mounted memory I/O connector.

## 11. SPECIFICATIONS

Power requirements	AC 100 V- 240 V, 50/60 Hz, 40 W
Matrix configuration	8-input, 8-bus, 8-output
Input	+4 dB* (Max. +24 dB*), 10 k $\Omega$ , electronically-balanced, XLR-connector
Output	+4 dB* (Max. +24 dB*), 600 $\Omega$ , electronically-balanced, XLR-connector
Hum and noise	Less than -86 dB* (20-20 kHz), full assign
Frequency response	20-20 kHz +0.5dB, -2dB
Total harmonic distortion	Less than 0.05 % at 1 kHz, +4dB*
Crosstalk	Less than -70dB at 1 kHz
Preset memories	16 presets
System lock	OFF, 1, 2
Input /Output indicator	Input to bus : 64-dot, green LED Bus to output : 64-dot, red LED
Status indication	64-dot LED
Memory No. /Device No. indication	Double digit LED
Master indication	Green LED
Communication	Single unit control : RS-232C, 9-pin D-SUB connector System control : RS-485, XLR-3-31 , 3-32 type connector
Control input	External memory selection by make contact
Control output	Output of memory selection status ( TTL level)
Control software	Corresponding to MS-Windows
Dimensions	483(W) x 88.4(H) x 328(D) mm (19.0 x 3.5 x 12.9 in.), 2-size (EIA)
Weight	6kg (13.2lb.)
Color	Black
Standard Accessories	AC power cord ••• 1, Rack mounting screw ••• 4, Operating instructions ••• 1 AC fuse ••• 1

Specifications are subject to change without notice.

\*0 dB is referenced to 0.775 V RMS.

# 12. APPEARANCE

