



MU-110 VERSION

**FUNCTIONS AND
OPERATING INSTRUCTIONS**

**INSTITUTIONAL
COMMUNICATION
SYSTEM**

IC-100

Please follow the instructions in this manual to obtain the optimum results from this system.
We also recommend that you keep this manual handy for future reference.

TOA Corporation

FCC REQUIREMENTS

- (1) This equipment complies with Part 68 of the FCC rules. On the front panel of this equipment is a label that contains, among other information, the FCC registration number and ringer equivalence number (REN) for this equipment. If requested this information must be provided to the telephone company.
- (2)

USOC Jack	RJ11C or RJ11W
Service Order Code	9.0F
Facility Interface Code	02LS2
- (3) The REN is used to determine the quantity of devices which may be connected to the telephone line. Excessive REN's on the telephone line may result in the devices not ringing in response to an incoming call. In most, but not all areas, the sum of the REN's should not exceed five (5.0). To be certain of the number of devices that may be connected to the line, as determined by the total REN's contact the telephone company to determine the maximum REN for the calling area.
- (4) If the terminal equipment IC-100 causes harm to the telephone network, the telephone company will notify you in advance. But if advance notice is not practical, the telephone company will notify the customer as soon as possible. Also, you will be advised of your right to file a complaint with the FCC if you believe it is necessary.
- (5) The telephone company may make changes in it's facilities, equipment, operations, or procedures that could affect the operation of the equipment. If this happens, the telephone company will provide advance notice in order for you to make the necessary modifications in order to maintain uninterrupted service.
- (6) If trouble is experienced with this equipment IC-100, please contact Toa Electronics Inc., 601 Gateway Boulevard South Sanfrancisco, CA 9408023 No.415- 588-2538 for repair and warranty information. If the trouble is causing harm to the telephone network, the telephone company may request you remove the equipment from the network until the problem is resolved.
- (7) This equipment may not be used on coin service provided by the telephone company. Connection to party lines is subject to state tariffs.
- (8) This equipment is hearing aid compatible.

DOC NOTICE 1.

"NOTICE: The Canadian Department of Communications label identifies certified equipment. This certification means that the equipment meets certain telecommunications networks protective, operational and safety requirements. The Department does not guarantee the equipment will operate to the user's satisfaction.

Before installing this equipment, users should ensure that it is permissible to be connected to the facilities of the local telecommunications company. The equipment must also be installed using an acceptable method of connection. In some cases, the company's inside wiring associated with a single line individual service may be extended by means of a certified connector assembly (telephone extension cord). The customer should be aware that compliance with the above conditions may not prevent degradation of service in some situations.

Repairs to certified equipment should be made by an authorized Canadian maintenance facility designated by the supplier. Any repairs or alterations made by the user to this equipment, or equipment malfunctions, may give the telecommunications company cause to request the user to disconnect the equipment.

Users should ensure for their own protection that the electrical ground connections of the power utility, telephone lines and internal metallic water pipe system, if present, are connected together. This precaution may be particularly important in rural areas.

Caution : Users should not attempt to make such connections themselves, but should contact the appropriate electric inspection authority, or electrician, as appropriate.”

DOC NOTICE 2.

”The Load Number (88) assigned to each terminal device denotes the percentage of the total load to be connected to a telephone loop which is used by the device, to prevent overloading. The termination on a loop may consist of any combination of devices subject only to the requirement that the total of the Load Numbers of all the devices does not exceed 100.”

DOC AVIS 1.

“**AVIS :** -L'étiquette du ministère des Communications du Canada identifie le matériel homologué Cette étiquette certifie que le matériel est conforme à certaines normes de protection, d'exploitation et de sécurité des réseaux de télécommunications. Le Ministère n'assure toutefois pas que le matériel fonctionnera à la satisfaction de l'utilisateur.

Avant d'installer ce matériel, l'utilisateur doit s'assurer qu'il est permis de le raccorder aux installations de l'entreprise locale de télécommunication. Le matériel doit également être installé en suivant une méthode acceptée de raccordement. Dans certains cas, les fils intérieurs de l'entreprise utilisés pour un service individuel à ligne unique peuvent être prolongés au moyen d'un dispositif homologué de raccordement (cordon prolongateur téléphonique interne). L'abonné ne doit pas oublier qu'il est possible que la conformité aux conditions énoncées ci-dessus n'empêchent pas la dégradation du service dans certaines situations. Actuellement, les entreprises de télécommunication ne permettent pas que l'on raccorde leur matériel à des jacks d'abonné, sauf dans les cas précis prévus par les tarifs particuliers de ces entreprises.

Les réparations de matériel homologué doivent être effectuées par un centre d'entretien canadien autorisé désigné par le fournisseur. La compagnie de télécommunications peut demander à l'utilisateur de débrancher un appareil à la suite de réparations ou de modifications effectuées par l'utilisateur ou à cause de mauvais fonctionnement.

Pour sa propre protection, l'utilisateur doit s'assurer que tous les fils de mise à la terre de la source d'énergie électrique, des lignes téléphoniques et des canalisations d'eau métalliques, s'il y en a, sont raccordés ensemble. Cette précaution est particulièrement importante dans les régions rurales.

Avertissement. -L'utilisateur ne doit pas tenter de faire ces raccordements lui-même; il doit avoir recours à un service d'inspection des installations électriques, ou à un électricien, selon le cas.”

DOC AVIS 2.

“L'indice de charge (88) assigné à chaque dispositif terminal indique, pour éviter toute surcharge, le pourcentage de la charge totale qui peut être raccordée à un circuit téléphonique bouclé utilisé par ce dispositif. La terminaison du circuit bouclé peut être constituée de n'importe quelle combinaison de dispositifs, pourvu que la somme des indices de charge de l'ensemble des dispositifs ne dépasse pas 100.”

WARNING: (For U.S.A. only)

This equipment generates, uses, and can radiate radio frequency energy and if not installed and used in accordance with the instructions manual, may cause interference to radio communications. It has been tested and found to comply with the limits for a Class A computing device pursuant to Subject J of Part 15 of FCC Rules, which are designed to provide reasonable protection such interference when operated in a commercial environment.

Operation of this equipment in a residential area is likely to cause interference in which case the user at his own expense will be required to take whatever measures may be required to correct the interference.

CONTENTS

Introduction 7

Section 1. Sub-Station Operation

1.1 Nomenclature

(1) RS-110 Sub-Station Handset 8
(2) RS-100 Switch Panel 8
(3) RS-120 Sub-Station 9
(4) RS-130 Sub-Station 9

1.2 Sub-Station Speaker Communication

(1) Calling 10
(2) Being Called 10~11
(3) Privacy Switch Use 11
(4) Emergency Calls 11

1.3 Sub-station Handset Use

(1) Calling 12
(2) Being Called 12~13
(3) Privacy Mode Conversation 13
(4) Emergency Calls 13

Section 2. Basic Control Station Operation

2.1 Nomenclature and Functions

(1) AS-100A Control Station 14~15
(2) AS-110 Control Station 16~17

2.2 Internal Line Call Operation

(1) Calling 18
 (1.1) Control Station to Control Station
 (1.2) Control Station to Sub-Station
(2) Being Called 19
 (2.1) Control Station to Control Station
 (2.2) Sub-Station to Control Station
(3) Privacy Function 20
(4) Summary of Conversation Method 20
(5) Sub-Station Mode Displays 21
(6) Sub-Station Display Priorities 21~22

(7) Emergency Functions	23
(7.1) Emergency Call	
(7.2) Duress Alarm	
(7.3) Summary of Emergency Functions	
2.3 Outside Call Operation	24
(1) Calling	
(2) Being Called	
2.4 Paging	
(1) All-Call Paging	25
(2) Zone Paging	26
(3) Combination Zone Paging	26
(4) Sub-Station Paging	27
(5) Emergency All-Call Paging	27
(6) PA paging	28-29
(7) External Microphone All-Call Paging	29
(8) Number of Zones	29
(9) Temporary Station Output Disable	29-30
(10) Summary of Paging Operation	31
(11) Transmission Priority List	31
(12) Dial Operation While Being Paged	31

Section 3. Convenient Control Station Functions

3.1 Applicable to Both Internal and Outside Calls	
(1) Redialing	32
(2) Speed Dialing	32
(3) Call Transfer	33-34
(4) Call Forwarding	35
(5) Auto-Call C/O Transfer	36-37
3.2 Internal Line Calls	
(1) Selective Response	38-40
(2) Conference	41
(3) Control Station Group Call	42
3.3 Scan Monitor	
(1) Automatic Scanning	
(1.1) Scan Monitor	43
(1.2) Monitor Interval Registration	44
(1.3) Scan Monitor Cancellation	44
(2) Manual Scanning	44
(2.1) Automatic Scanning Stop & Restart	
(2.2) Scan FORWARD	
(2.3) Scan BACK	
3.4 PBX Station Intercommunication	
(1) System Station to PBX Station Calls	45
(1.1) Control Station to PBX Station Calls	45
(1.2) Sub-Station to PBX Station Calls	46
(2) PBX Station to System Station Calls	47
(2.1) PBX Station to Control Station Calls	47
(2.2) PBX Station to Sub-Station Calls	48-49
(2.3) PBX Station to System Paging	49-50

Section 4. Auxiliary Functions and Operating Precautions

4.1 Time Setting and Adjustment	51
(1) Time Setting	
(2) 12/24-Hour Mode Switching	
(3) Second Synchronization	
4.2 Station Priority Registration and Calling	52
(1) Registration	
(2) Cancellation	
(3) Reviewing the Registered Stations and Call to Them	
4.3 Time Signal	
(1) Time Schedule Selection (Automatic Output)	53
(2) Manual Output	53~55
(3) Summary of Time Signal Manual Output Operation	56
4.4 Program Source Output	
(1) All-Zone Output	57
(2) Zone Output	58
(3) Combination Zone Output	58
(4) Sub-Station Output	58
(5) Confirmation, Re-Output and Output Stop of Registered Programs	58
(6) Program Source Output Indication	59
(7) Number of Zones	59
(8) Temporary Station Output Disable	59~60
(9) Summary of Program Source Output Operation	60
4.5 Computer Connection	60

Section 5. Function and Operation Tables

5.1 Dialing Operations	
(1) Quick Reference to Dialing Operations	
(1.1) Sub-Station	61
(1.2) Control Station	61~65
(2) Transmission Area Registration	66
5.2 Priority Order	67
(1) Broadcast/Conversation Priority	
(2) Call Display Priority	
5.3 Signal Tones	68
5.4 Operation Display Examples	
(1) Reception	69
(2) Transmission	70
(3) Miscellaneous	70
5.5 Note of Operation	
(1) Emergency Call	
(2) Paging	
(3) Number of Storable Waiting Stations	
(4) Call Display Memory Clear	
5.6 Restrictions by Tie-Line Systems	71
(1) Call Forwarding	
(2) Access to C/O Line Calls	
(3) C/O Line Conversation	

Introduction

This manual explains all of the functions and operation of the TOA Institutional Communication System. This includes functions that cannot be performed by the system as initially purchased. This manual is divided into the following five sections, so only the sections directly related to your application need be referred to.

Section 1. Sub-Station Operation

Section 2. Basic Control Station Operation

Section 3. Convenient Control Station Functions

Section 4. Auxiliary Functions and Operating Precautions

Section 5. Function & Operation Tables

The TOA Institutional Communication System is designed to provide efficient administrative communication capability in schools, correctional, and other related facilities. Its basic communication network is illustrated below.

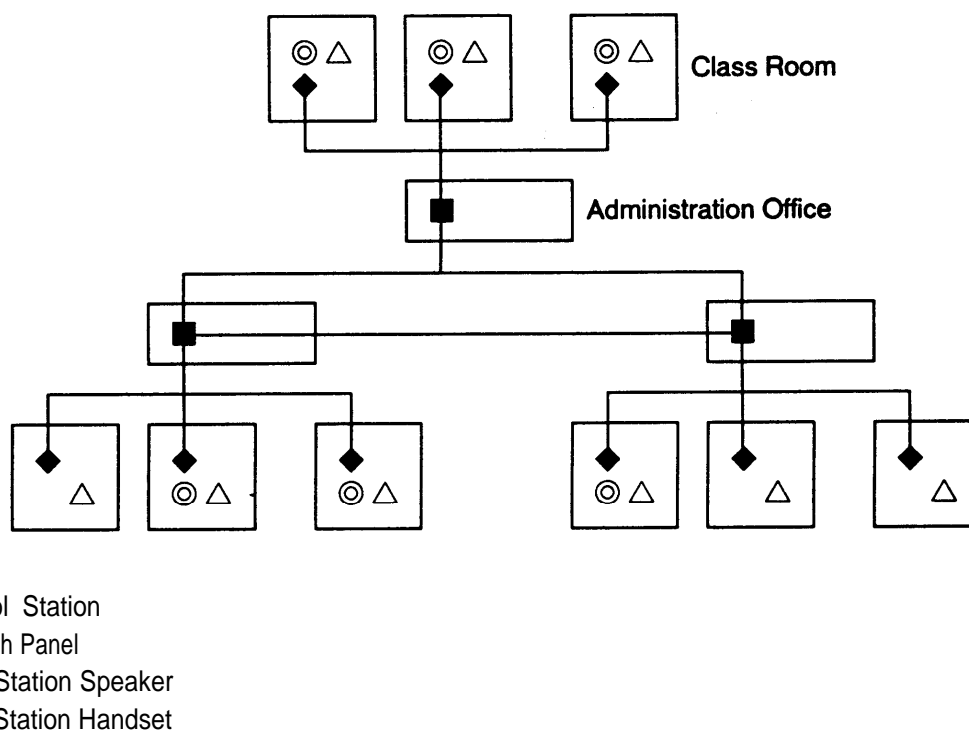

The term "SUB-STATION" refers to the combination of the RS-100 Switch Panel, the RS-110 Sub-Station Handset, and a remote speaker unit. Although the sub-station handset may not be installed in some rooms, the remaining switch panel/ speaker set will still be referred to as the sub-station.

There are also other sub-stations in which both a speaker and a call button are encased as a single body. However, they are not equipped with an LED or Privacy button.

SECTION 1. SUB-STATION OPERATION

1.1 Nomenclature

(1) RS-110 Sub-Station Handset

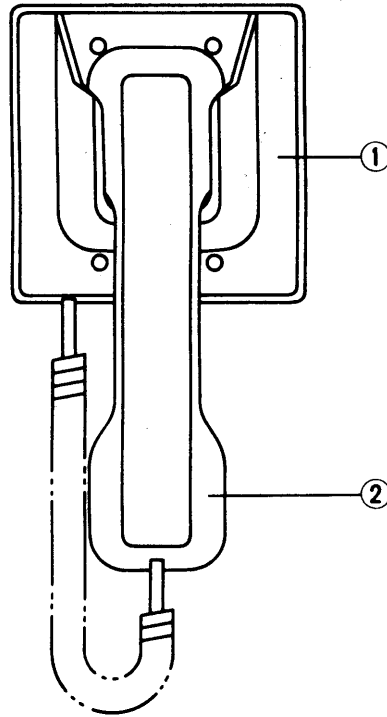

- ① Wall-mounted handset cradle
- ② Handset

(2) RS-100 Switch Panel

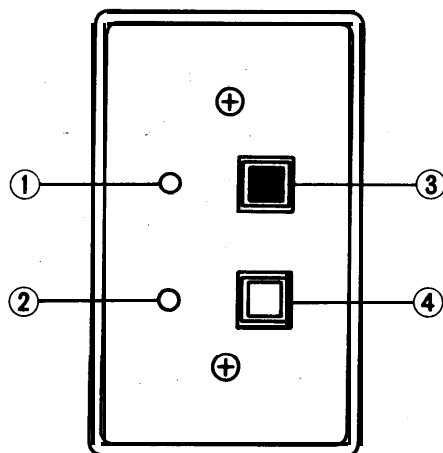

- ① Upper LED
- ② Lower LED
- ③ [CALL] switch button
- ④ [PRIVACY] switch button

(3) RS-120 Sub-Station (Flush-Mount Type)

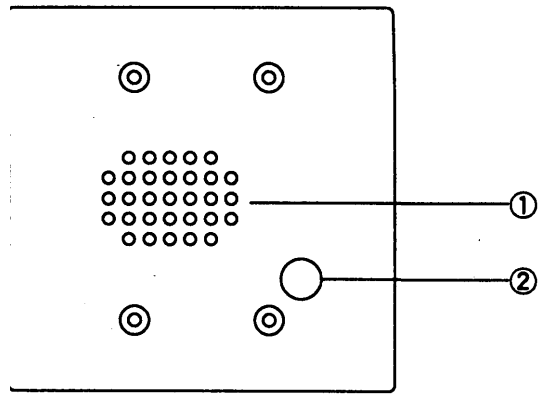

- ① Speaker
- ② [CALL] switch button

(4) RS-130 Sub-Station (Flush-Mount type)

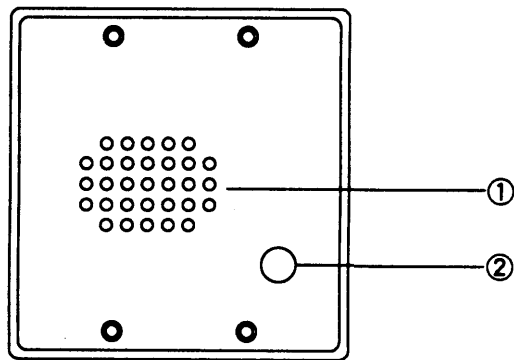

- ① Speaker
- ② [CALL] switch button

1.2 Sub-station Speaker Communication

The sub-station speaker is used exclusively for inter-station communication in rooms not equipped with a sub-station handset. Although either the sub-station handset or sub-station speaker can be used in rooms

(1) Calling

- ① Depress the red **CALL** switch on the switch panel.
- ② The corresponding upper LED flashes.
- ③ The flashing LED turns to steady when the party being called answers.
- ④ Conversation possible.
- ⑤ When the conversation ends, the LED goes out.

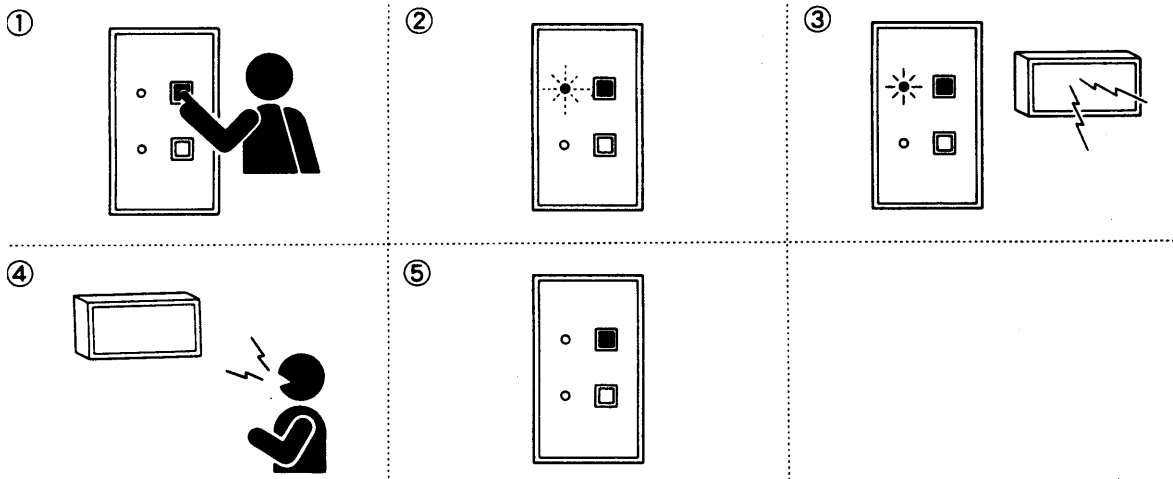

[Note] : (1) If the party being called in Step 3 is on another line or otherwise busy, the LED continues to flash until the party answers.

(2) Integrated type sub-stations (RS-120 and RS-130) come with neither an LED nor a Privacy button.

(2) Being Called

- ① Following a brief tone, the calling party's voice is heard.
- ② The upper LED lights.
- ③ Conversation possible.
- ④ When the conversation ends, the LED goes out.

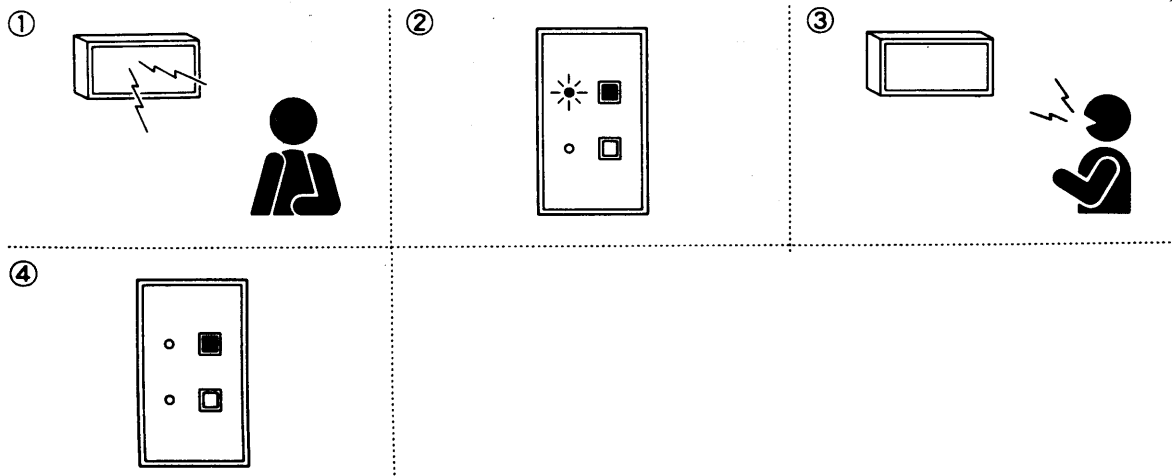

● Conversation Method

Only one party may speak at a time, therefore it is necessary for the other party to finish talking before speaking. The speaker will then function as a microphone to convey your voice. This method of communication is referred to as “half-duplex.”

In rooms equipped with sub-station handsets, the handset may be picked up at any time to continue the conversation in “full-duplex” mode. For further information, refer to Section 2. 2-(4) Summary of conversation method.

[Note]: An intermittent signal tone can be heard over the speaker if another party is calling or listening in.

(3) Privacy Switch Use

This switch is used to stop incoming calls or prevent in-room conversations from being overheard.

[Privacy Mode Registration]

Press the white [PRIVACY] switch, lighting the lower LED.

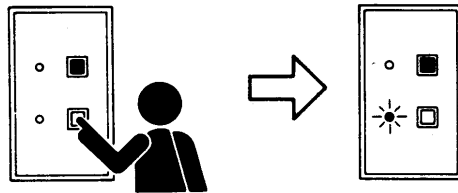

[Privacy Mode Cancellation]

Press the same switch again, extinguishing the LED.

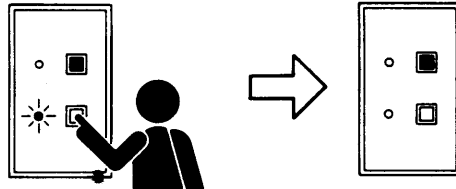

[Note]: (1) The sub-station can still be called while the privacy mode is enabled, although in-room conversation cannot be heard. To answer the call, press the [PRIVACY] switch (extinguishing the lower LED) and proceed with the conversation.

(2) Call switch operation remains possible even while the privacy mode is enabled. The privacy mode is resumed when the conversation ends.

(4) Emergency Calls [Selectable Function]

In emergency situations, continuously press the red [CALL] switch for at least 3 seconds.

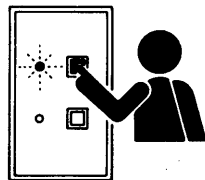

For at least 3 seconds

[Note]: No emergency calls can be accepted during emergency all-call paging. In such a case, restart operation.

1.3 Sub-Station Handset Use

All sub-stations include the switch panel, whether the sub-station handset is installed or not. Although either the sub-station handset or sub-station speaker can be used in rooms equipped with both, only sub-station handset use will be explained in this section. Refer to Section 1.2 for Sub-station speaker applications.

(1) Calling

- ① Lift up the sub-station handset.
- ② The corresponding upper LED on the switch panel flashes.
- ③ The flashing LED remains lit when the party being called answers.
- ④ Conversation possible.
- ⑤ Replace the handset when the conversation ends.
- ⑥ The LED goes out.

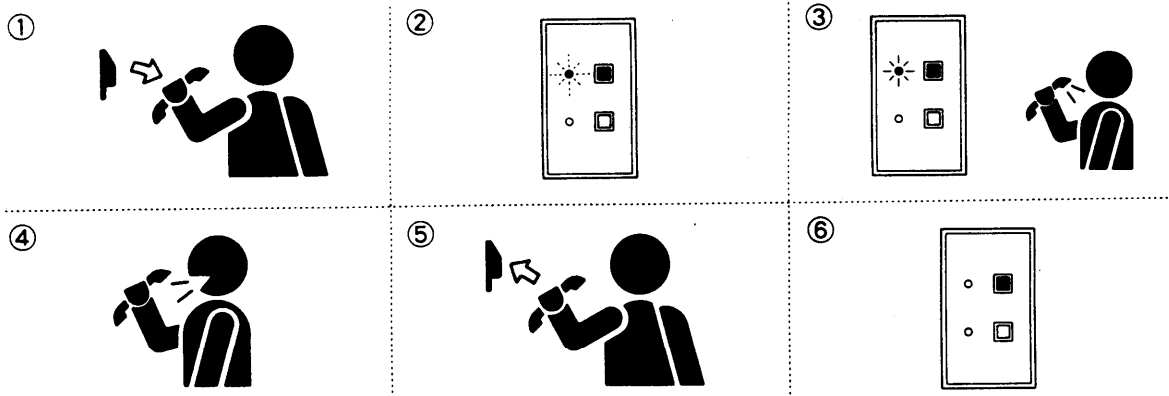

[Note]: If the party being called in Step 3 is on another line or otherwise busy, the LED continues to flash until the party answers. In this case, simply wait for the other party to answer by either holding the handset or replacing it in its cradle.

(2) Being Called

- ① Following a brief tone, the calling party's voice is heard.
- ② The upper LED on the switch panel lights.
- ③ Lift up the sub-station handset.
- ④ Conversation possible.
- ⑤ Replace the handset when the conversation ends.
- ⑥ The LED goes out.

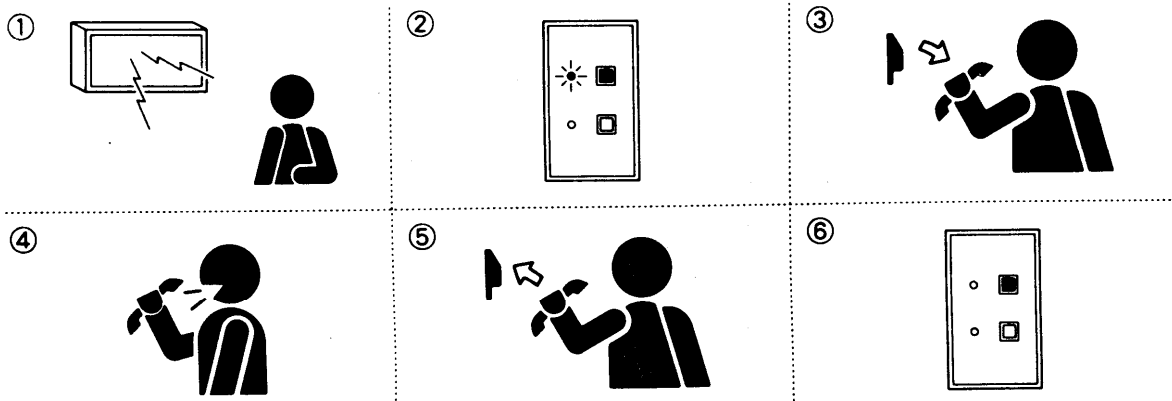

Conversation Method

While the control station handset remains in its cradle, the conversation method will be half-duplex like the conversation through the sub-station speaker. When the handset is used, regular 2-way telephone (full-duplex) conversation becomes possible.

Privacy Mode Conversation (Lower LED lit)

The sub-station can still be called while the privacy mode is enabled, although in-room conversation cannot be heard. To answer the call, press the [PRIVACY] switch (extinguishing the lower LED) and proceed with the conversation.

Picking up the sub-station handset makes a call even while the privacy mode is enabled. The privacy mode is resumed when the handset is replaced.

(4) Emergency Calls [Selectable Function]

In emergency situations while the handset is in use, continuously press the red [CALL] switch for at least 3 seconds.

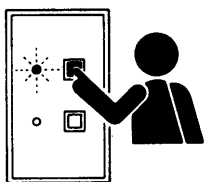

For at least 3 seconds

[Note]: No emergency calls can be accepted during emergency all-call paging. In such a case, restart operation.

SECTION 2. Basic Control Station Operation

2.1 Nomenclature and Functions

(1) AS-100A Control Station (Desk-/Wall-Mount Type)

[Front view]

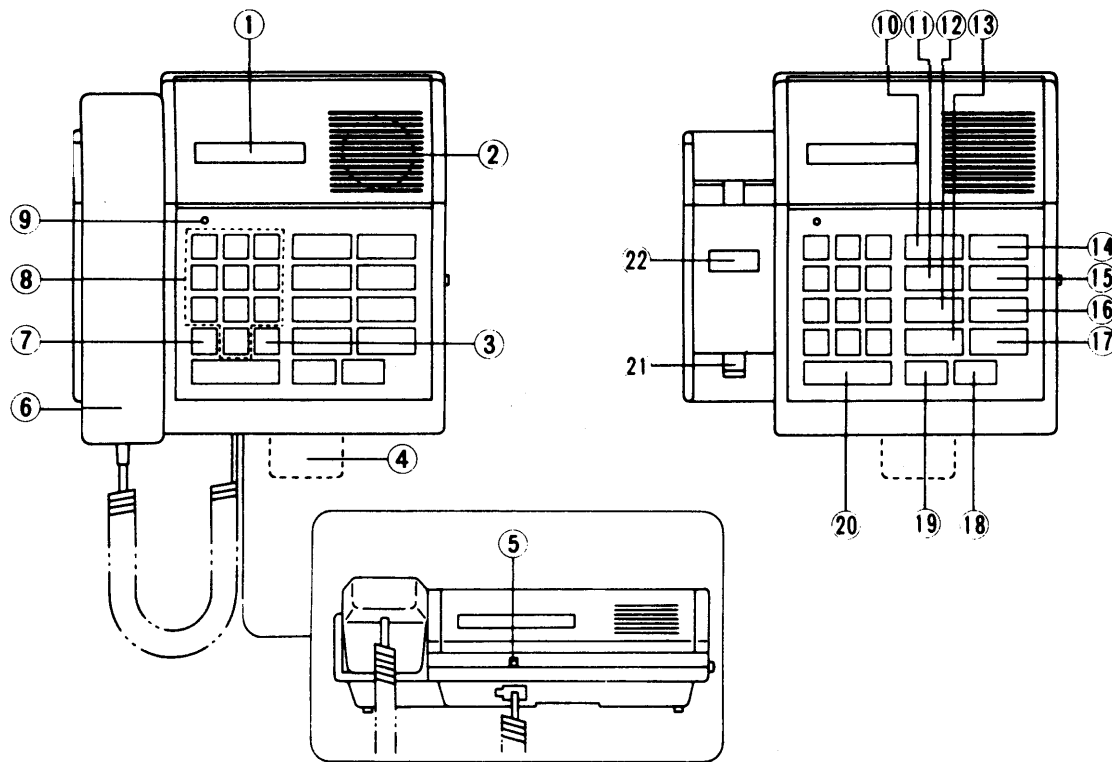

- ① **Display panel** : Shows connection status and registered data.
- ② **Internal speaker** : Sounds call tones and permits "handsfree" conversation.
- ③ **[C/#] key** : Terminates calls and accesses special C/O line functions as well as other special programming functions.
- ④ **Station number directory**
- ⑤ **Internal microphone** : Used in "handsfree" operation.
- ⑥ **Handset**
- ⑦ **[*] key** : Used for privacy mode selection and other special programming functions.
- ⑧ **[0]-[9] keypad** : Used for dialing.
- ⑨ **In-use lamp**
- ⑩ **[DISPLAY CALLS] key** : Displays waiting station numbers, as well as registered data.
- ⑪ **[TELEPHONE] key** : Accesses outside telephone lines.
- ⑫ **[CONFERENCE] key** : Used to enable conference function.
- ⑬ **[PAGE] key**: Used for paging.
- ⑭ **[TIME FUNCTION] key**: Selects pre-programmed time schedules ; Permits manual operation of time signals.
- ⑮ **[REDIAL] key** : Automatically redials last dialed number.
- ⑯ **[PROGRAM] key**: Programs zone distribution of program source.
- ⑰ **[PRIORITY] key** : Establishes sub-station priority.
- ⑱ **[ALL] key** : Broadcasts paging, time signal, and program source over entire area.
- ⑲ **[ZONE] key** : Broadcasts paging, time signal, and program source to selected zones.
- ⑳ **[PUSH TO TALK] key**: Used in PTT operation ; Permits contact with stations in privacy mode ; Selects and dials displayed station.
- ㉑ **Hook switch**
- ㉒ **Station number card**

[Top view]

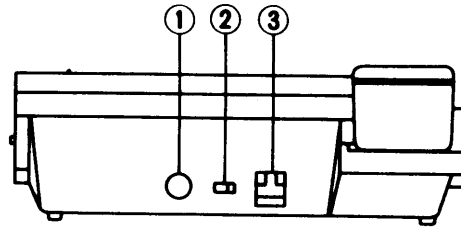

[Side view]

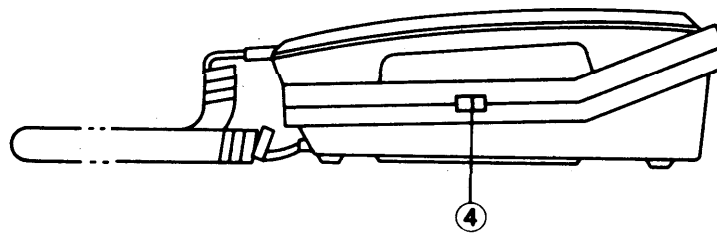

- ① **[EXTERNAL MIC/HEADSET]** : External microphone or headset jack.
- ② **[REGISTER ON/OFF]** : Enables or disables system programming functions.
Normally set to OFF.
- ③ **[LINE] connector** : Used for connection to exchange.
- ④ **[SP.VOL.(H/L)]** : Internal speaker volume selection.

(2) AS-110 Control Station (Console/Wall-Mount Type)

[Front view]

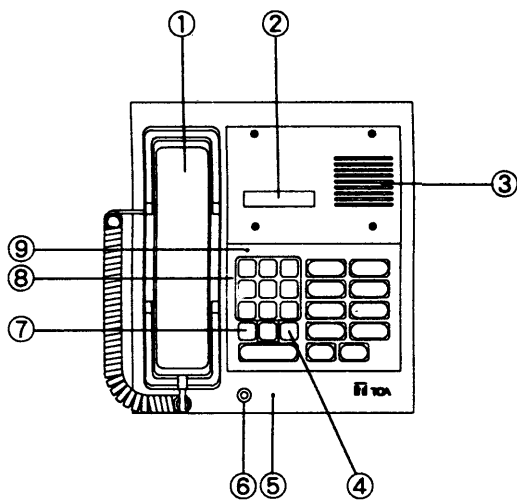

[Front view without a speaker cover]

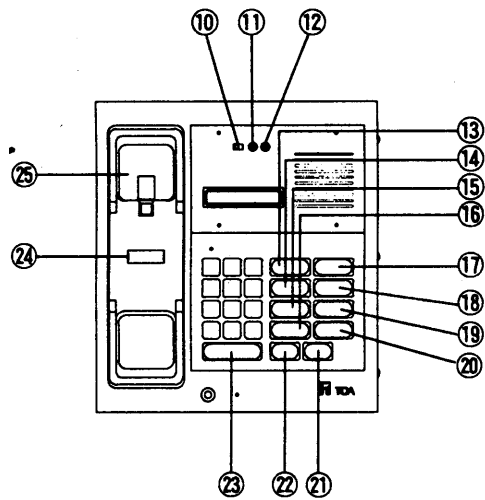

- ① **Handset**
- ② **Display panel** : Shows connection status and registered data.
- ③ **Internal speaker** : Sounds call tones and permits "handsfree" conversation.
- ④ **[C/#] key** : Terminates calls and accesses special C/O line functions as well as other special programming functions.
- ⑤ **Internal microphone** : Used in "handsfree" operation.
- ⑥ **[EXTERNAL MIC/HEADSET] jack** : External microphone or headset jack.
- ⑦ **[*] key** : Used for privacy mode selection and other special programming functions.
- ⑧ **[0]-[9] keypad**: Used for dialing.
- ⑨ **In-use lamp**
- ⑩ **[REGISTER ON/OFF] switch** : Enables or disables system programming functions. Normally set to OFF.
- ⑪ **[SP]** : Adjusts internal speaker volume.
- ⑫ **[MIC]** : Adjusts "handsfree" operation microphone sensitivity.
- ⑬ **[DISPLAY CALLS] key** : Displays waiting station numbers, as well as registered data.
- ⑭ **[TELEPHONE] key** : Accesses outside telephone lines.
- ⑮ **[CONFERENCE] key** : Used to enable conference function.
- ⑯ **[PAGE] key**: Used for paging.
- ⑰ **[TIME FUNCTION] key**: Selects pre-programmed time schedules ; Permits manual operation of time signals.
- ⑱ **[REDIAL] key** : Automatically redials last dialed number.
- ⑲ **[PROGRAM] key**: Programs zone distribution of program source.
- ⑳ **[PRIORITY] key** : Establishes sub-station priority.
- ㉑ **[ALL] key**: Broadcasts paging, time signal, and program source over entire area.
- ㉒ **[ZONE] key** : Broadcasts paging, time signal, and program source to selected zones.
- ㉓ **[PUSH TO TALK] key** : Used in PTT operation. Permits contact with stations in privacy mode ; Selects and dials displayed station.
- ㉔ **Station number card**
- ㉕ **Hook switch**

- [Note]:** (1) Dialing can be performed with either the handset lifted or in place (handsfree operation). Likewise calls can be answered in either condition if the calls are from internal stations.
- (2) System programming procedures are not provided in this manual. Refer to the accompanying Installation Manual for this information.
- (3) Using an external headset or microphone
- (3.1) Although use of the above-mentioned external headset and microphone are not explained in this manual, if a headset is connected, its operation is essentially the same as that of the handset. Likewise, if an external microphone is connected, its operation is essentially the same as that of the internal microphone.
- (3.2) <For only the systems employing the Duress Alarm function>
When an external headset or microphone is connected to the MIC/HEADSET jack, a single tone is heard. Press the [C/#] key upon hearing the tone. (If the [C/#] key is not pressed, the "duress alarm" function is operated. In such cases, press the [C/#] key, then remove the headset (microphone) from the jack.)
- (3.3) To disable an internal speaker when using the headset, the control station has to be modified. (Refer to the IC-100 installation handbook.)
- (3.4) Be sure to connect the headset (microphone) only when the exchange power is ON (i.e. when characters are indicated on the display panel). Note that if the exchange power switch is set to ON with the headset (microphone) connected, a one-way conversation by [PUSH TO TALK] key will result instead of a simultaneous (duplex) conversation.

2.2 Internal Line Call Operation

(1) Calling

(1.1) Control station to control station

- ① Dial the desired station number.
(Dialing can be performed with the handset lifted or replaced.)
- ② A brief call tone is heard at the calling station.
- ③ Conversation can proceed when the called party answers.
- ④ To terminate the conversation, replace the handset or press the [C/#] key.

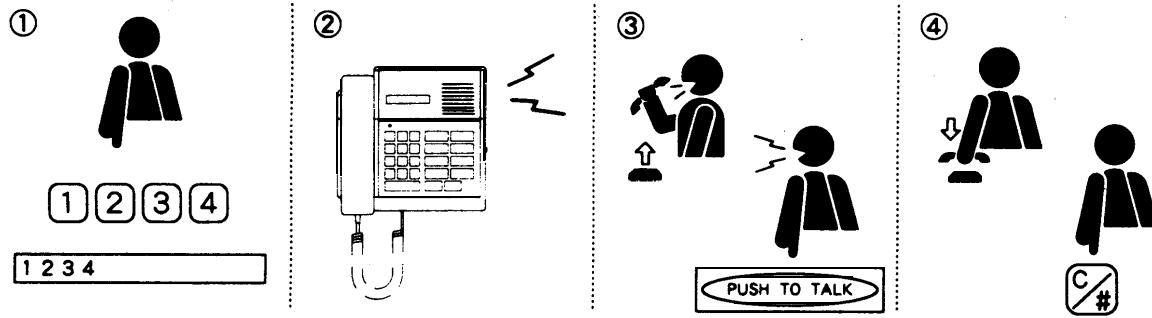

[Note] : Dialing can be performed with the handset either lifted or in place (handsfree dialing). Simultaneous full-duplex conversation is possible with the handset lifted once the called party answers.

Full-duplex conversation is also possible when the calling station is in handsfree mode and the called party uses its handset. When both stations are in handsfree mode, only one-way PTT (Push to talk) conversation is possible, and the [PUSH TO TALK] key has to be pressed to talk and released to listen. However, should either party lift its handset during PTT operation, the conversation will automatically be switched to full-duplex operation.

(1.2) Control station to sub-station

- ① Dial the desired room station number.
- ② A brief call tone is heard. Lift up the handset or press [PUSH TO TALK] key.
- ③ Conversation can proceed.
- ④ To terminate the conversation, replace the handset or press the [C/#] key.

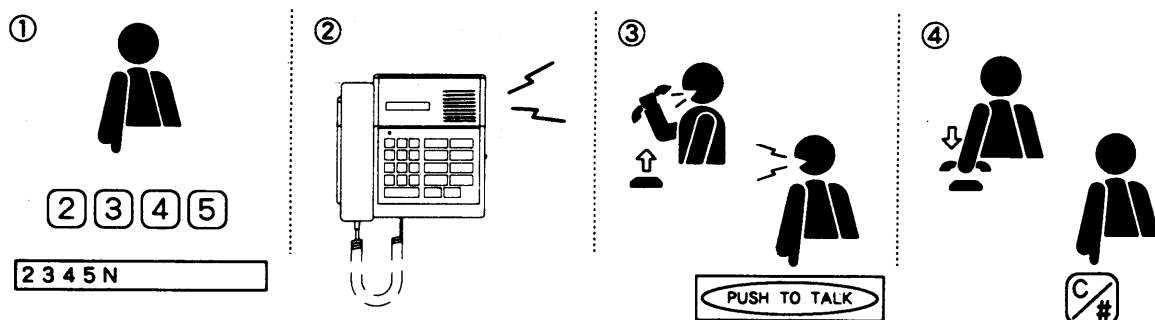

[Note]: Full-duplex conversation is possible when both the control station handset and sub-station handset are lifted. When the control station handset is lifted and sub-station communication is via the sub-station speaker, only half-duplex voice-actuated conversation is possible. When the control station is in handsfree mode, only half-duplex PTT conversation is possible, regardless of the sub-station mode. Once the [PUSH TO TALK] key is pressed, full-duplex conversation becomes no longer possible.

(2) Being Called

(2.1) Control station to control station

- ① A brief call tone is heard.
- ② Conversation possible upon answering.
- ③ Conversation ends.

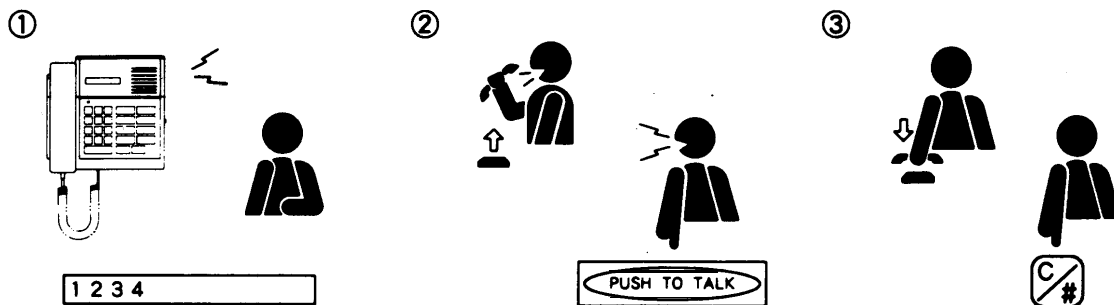

If the conversation has been terminated by the calling party, the called party need not operate any key for termination. The called party can terminate the conversation by replacing the handset or pressing the [C/#] key.

(2.2) Sub-station to control station

- ① A call tone is heard.
- ② Conversation possible upon answering.
- ③ To terminate the conversation, either replace the handset or press the [C/#] key.



[Note]: (1) The call tone differs depending on the priority level of the station. Refer to the "Section (6) Sub-Station Display Priorities" of this operation manual.

(2) Refer to the "Section 3.2 Internal Line calls (1) Selective Response" and "Section 5.2 Priority Order" of IC-100's Functions and Operating Instructions.

(3) Privacy Function

This function is used to refuse all incoming calls. The control station can be put in Privacy mode by pressing the [*] key twice, showing "PV" and the current time on the station display ([PV A 10:34pm]). If a call is received while in the Privacy mode, a privacy tone is heard. Pressing the [*] and [C/#] keys cancels the Privacy mode and extinguishes the "PV" display ([A 10:34pm]).

Response to calls can still be made from the control station while the Privacy mode is enabled. If a call is made from the control station to another control station in the Privacy mode, a Privacy signal sounds at the calling and called stations for a period of time. This signal is different from that heard when calling a sub-station in Privacy mode. (Control station privacy tone : Intermittent trill tone, Sub-station privacy tone: Intermittent single tone)

(4) Summary of Conversation Method

In summary, there are three different conversation methods:

(4.1) Simultaneous conversation (Duplex)

Similar to that of a standard telephone.

(4.2) Voice-actuated two-way conversation (V.S.)

The conversation flow is automatically switched via the voice switch. in quiet areas, this is similar to simultaneous conversation. However, when the ambient noise level at the control station is too high, interfering with smooth conversation, the [PUSH TO TALK] key can be depressed to switch to the PTT conversation mode.

(4.3) PTT conversation (PTT)

The control station [PUSH TO TALK] key is pressed to talk, and released to listen.

The following table shows the conversation modes for all of the various station combinations.

		Control Station		
		Handsfree	Handset	
Control Station	Handsfree	PTT	Duplex	
	Handset	Duplex	Duplex	
Sub-Station Speaker		PTT	V.S./PTT	
Sub-Station Handset		PTT	Duplex	
				* Sub-Station Handset

[Note]: Conversation between sub-station handsets is possible only when a call from either handset is transferred to the other handset via the control station.

(5) Sub-Station Mode Displays

“Busy”, “Privacy”, and “Off-Hook” indicators are displayed before their corresponding sub-station numbers on the control station display when these modes are in effect. “Busy” and “Privacy” displays are also accompanied by signal tones.

(5.1) Busy mode

The busy tone sounds and the “Busy” indicator is displayed whenever a sub-station is called while in use.

(**Busy 3456**)

(5.2) Privacy mode

The privacy tone sounds and the “Priv.” indicator is displayed whenever a sub-station is called while in the privacy mode.

(**Priv. 3456**)

(5.3) Off-hook mode

The “Off-Hook” indicator is displayed whenever a sub-station handset is not replaced within 10 seconds after ending a conversation. Replacing the sub-station handset extinguishes this indicator, which is only displayed while the control station is in its waiting mode. However, if any other sub-station handset is also off its hook, this indicator will continue to be displayed in front of the sub-station’s corresponding number.

(**Off-Hook3456**)

(6) Sub-Station Display Priorities

The numbers of all stations calling a control station are automatically stored and displayed in the priority order registered for each station. The control station can only display one of these “waiting” stations. When more than one station is waiting, the other waiting station number can be displayed with subsequent depressions of the [DISPLAY CALLS] key.

The following three fixed priority indications, shown in descending order of priority, can only be programmed within the system during system setup:

(A) Alarm (N) Normal (S) Staff

The following programmable priority indication can be independently programmed at each control station:

(P) Priority

[Note] : This highest “P” priority setting can be temporarily assigned to any sub-station at its corresponding control station.

Taking precedence over these priorities is an Emergency Call. Emergency Calls can be made with special key operations. Regardless of its arrival order, it is always displayed first whatever the priority of the other waiting stations. Priority levels of control stations are fixed to be lower than those of sub-stations.

Shown below are the registered priority displays and call tone types produced at the called control station. Call tones are not sounded at the called station if busy, in which case a busy tone is heard at the calling station.

DISPLAY PRIORITY	CALL DISPLAY	CALL TONE
1. Emergency Call	Emerg.	Intermittent trill tone
2. Priority Call	P	Intermittent single tone (Short pulse tone)
3. Alarm Call	A	
4. Normal Call	N	Intermittent single tone (Long pulse tone)
5. Staff Call	S	
6. Control Station	(*1)	

- [Note]:** (1) Waiting stations are arranged in priority order, with those having the same priority displayed on a first-come-first-served basis.
- (2) The numbers of calling control stations are also stored if the called control station has been called from other stations.
- (3) Incoming calls cannot be accepted while busy without terminating the current conversation.
- (*1) A brief trill tone is heard when an unused control station is called.

[Call Display Examples]

- | | | |
|---|--------------|--|
| ① | 1234N | No.1234 calling. |
| ② | 1234N M | Other stations calling. |
| ③ | 1234N | Connect to No.1234. |
| ④ | 1234N:2345S | No.2345 calling during conversation with No.1234. |
| ⑤ | 1234N:2345SM | Other stations besides No.2345 calling during conversation with No.1234. |

[Note]: The suffix "M" indicates other waiting stations, which can be displayed with subsequent depressions of the [DISPLAY CALLS] key.

(7) Emergency Functions [Selectable Function]

(7.1) Emergency call

This function is applicable only to sub-stations.

In emergency situations? continuously press the red [CALL] switch for at least 3 seconds.

The emergency call has the highest priority of all station calls.

[Note]: Neither emergency calls nor duress alarms can be accepted during emergency all-call paging. (In such a case, restart operation.)

(7.2) Duress alarm

This function is applicable only to control stations. In case of an emergency, simply take handset off its hook. The message [OFF-HOOK] will be displayed at the station six seconds after the handset is displaced, causing all other connected control stations to display the message accompanied by an emergency tone (not audible at the busy station).

The duress alarm function can be cancelled by replacing the handset after the [C/#] key depression.

[Note] : Voice transmission is not enabled by this function. To establish contact with the station in duress, its station No. must be first dialed at any of the receiving stations. However, it may be difficult to monitor the station in duress owing to the relatively poor sensitivity of the handset microphone in comparison with the station's "Handsfree" mode microphone.

(7.3) Summary of emergency functions

When any emergency communication has been received as indicated by the message as well as by an emergency tone (not audible at the busy station), first contact the calling station. The following examples show the emergency status:

- | | |
|------------------------|---|
| ① 3456 Emerg. | Emergency call from No.3456 sub-station.
To contact, press the [PUSH TO TALK] key or lift the handset. (To answer in busy mode, the current conversation must first be terminated.) |
| ② 5678 Duress | Duress alarm from No.5678 control station.
(No.5678's handset off the hook) |
| ③ 3456 Emerg. E | ① Emergency calls from No.3456 and other sub-stations,

② Emergency call from No.3456 and duress alarm from certain control station. |
| ④ 5678 DuressE | Duress alarm from No.5678 and other control stations. |
| ⑤ Emerg. Page | ① Emergency all-call paging during emergency call or duress alarm.
(Emergency call or duress alarm is displayed upon emergency all-call paging completion.)

② Emergency call or duress alarm entry during emergency all-call paging. (Neither emergency calls nor duress alarms can be accepted during emergency all-call paging. in such a case, restart operation.) |
| ⑥ 1234N:3456E | "E" is short for "Emerg." |
| ⑦ 3456N:5678D | "D" is short for "Duress". |

[Note]: The suffix "E" indicates waiting emergency calls or duress alarm, which can be displayed with subsequent depressions of the [DISPLAY CALLS] key.

2.3 Outside Call Operation [Selectable Function]

(1) Calling

- ① Press [TELEPHONE] key. (*1)
- ② Dial [Tel :0797712]
- ③ Outside telephone call tone is heard.
- ④ Lift up the handset. (The handset can be lifted before dialing.)
- ⑤ Conversation can proceed when called party answers.
- ⑥ Replace the handset to terminate the conversation.

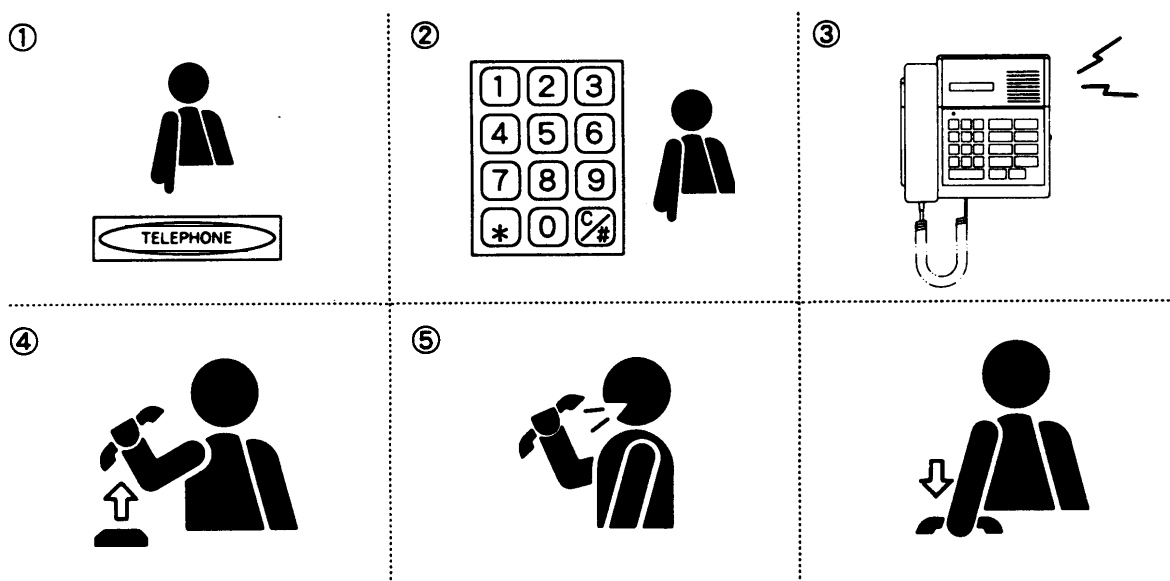

[Note] : (*1) For systems connected to both the C/O line and PBX, assign access Nos.1 and 2 to distinguish between the two. Refer to "3.4 PBX Station Intercommunication".
(Ex.: [TELEPHONE] [1] for C/O line calls, [TELEPHONE] [2] for PBX station calls)

(2) Being Called

- ① Outside telephone call tone is heard. [C/O LINE]
- ② Conversation can proceed by lifting up the handset.
- ③ Replace the handset to terminate the conversation.

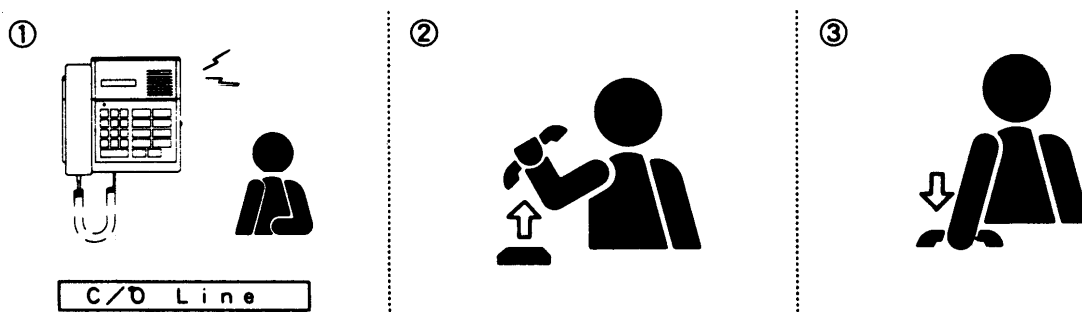

2.4 Paging [Selectable Function]

The following five paging methods are available to all control stations. In addition to these, the IC-100 also permits all-call paging from a connected external microphone, and all paging functions can be programmed for external PA paging.

Five different paging methods, including All-Call paging, can be selected with the IC-100 system.

- 1) All-Call Paging : Permits simultaneous paging through all zones. (No paging output is provided from the stations not assigned to any zone.)
- 2) Zone Paging : Permits simultaneous paging of up to nine pre-programmed individual zones (single-digit system) or up to 60 zones (virtually 59 zones because zone No. 60 is used for all-zone time signal broadcast) (double-digit system).
- 3) Combination Zone Paging : Permits simultaneous paging of up to nine pre-programmed combinations of zones.
- 4) Sub-Station Paging: Permits simultaneous paging of up to ten individual sub-stations.
- 5) Emergency All-Call Paging : Permits simultaneous emergency paging through all zones and connected external speakers.

[Paging Assignment Example]

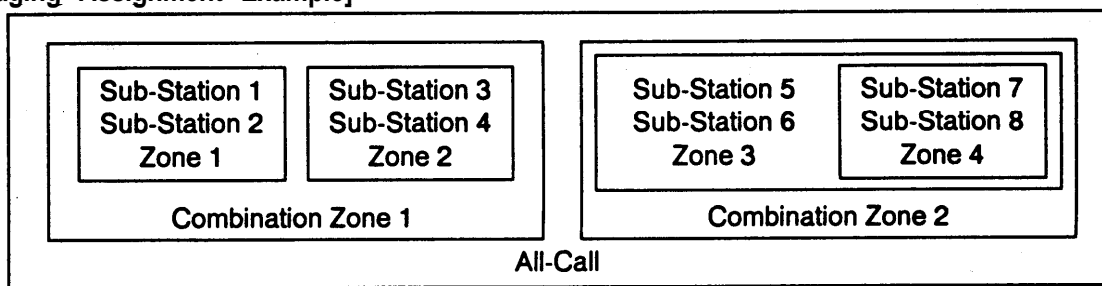

(1) All-Call Paging

- ① Press [PAGE] [ALL] keys.
- ② Press [PUSH TO TALK] key or lift handset. (Paging possible.)
- ③ A 4-note chime or paging pre-announcement tone sounds.
- ④ Place a paging call.
- ⑤ Replace handset or press [C/#] key to terminate the call.

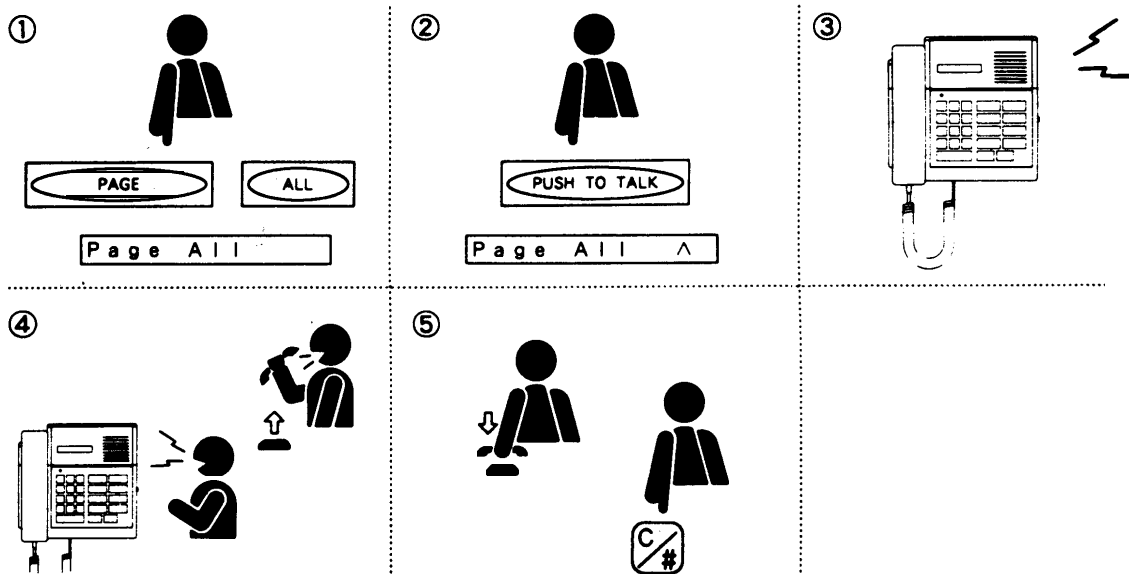

(2) Zone Paging

- ① Press [PAGE] [ZONE] keys.
- ② Dial the desired zone number(s). (Max. 9 zones can be selected simultaneously.)
- ③ Press [PUSH TO TALK] key or lift handset. (Paging possible.)
- ④ A 4-note chime or paging pre-announcement tone sounds.
- ⑤ Place a paging call.
- ⑥ Replace handset or press [C/#] key to terminate the call.

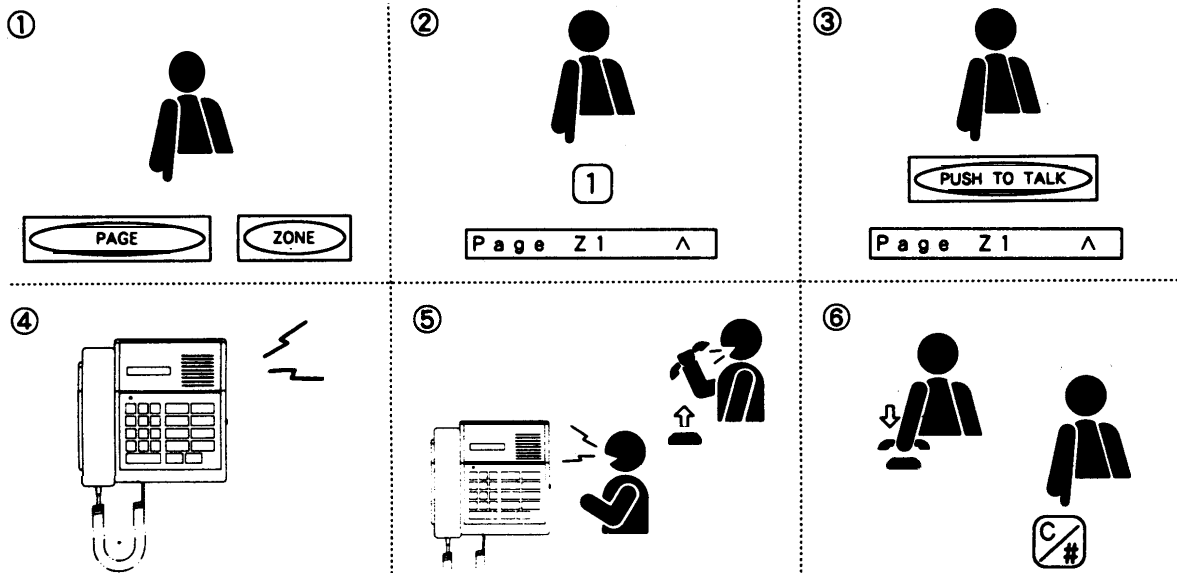

(3) Combination Zone Paging

- ① Press [PAGE] key.
- ② Dial the desired combination zone number(s). (Max. 9 combinationzones)
- ③ Press [PUSH TO TALK] key or lift handset. (Paging possible.)
- ④ A 4-note chime or paging pre-announcement tone sounds.
- ⑤ Place a paging call.
- ⑥ Replace handset or press [C/#] key to terminate the call.

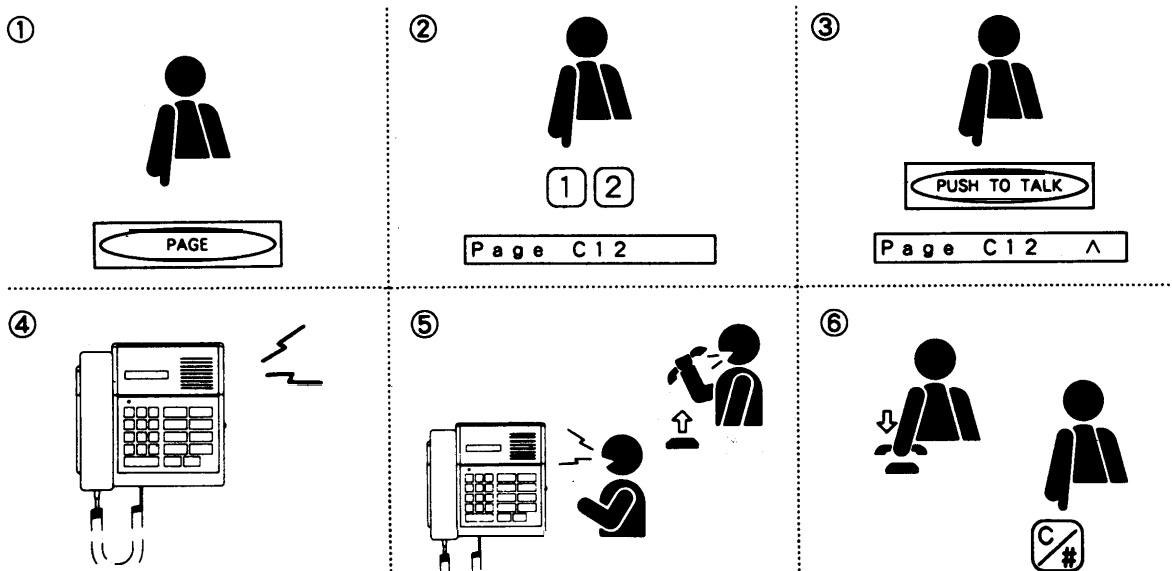

(4) Sub-Station Paging

- ① Press [PAGE] [*] keys.
- ② Dial the desired sub-station number(s). (Max. 10 stations)
- ③ Press [PUSH TO TALK] key or lift handset: (Paging possible.)
- ④ A 4-note chime or paging pre-announcement tone sounds.
- ⑤ Place a paging call.
- ⑥ Replace handset or press [C/#] key to terminate the call.

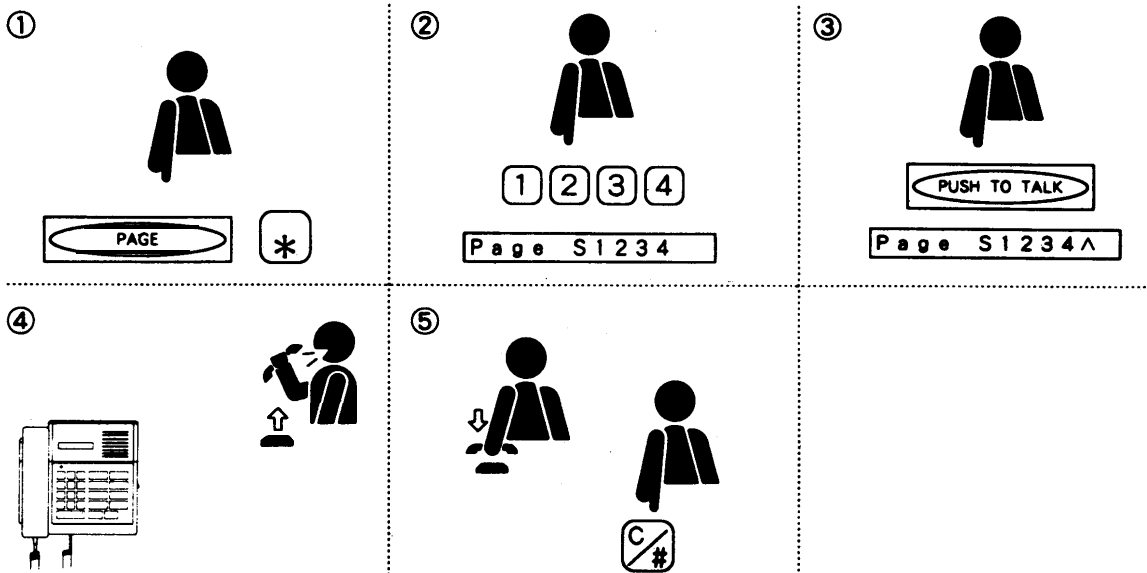

(5) Emergency All-Call Paging

- ① Press [PAGE] key four times or more in rapid sequence.
(The emergency page cannot be performed if the interval exceeds 0.5 seconds.)
- ② An emergency all-call paging pre-announcement tone sounds.
- ③ Place a paging call.
- ④ Replace handset or press [C/#] key to terminate the call.

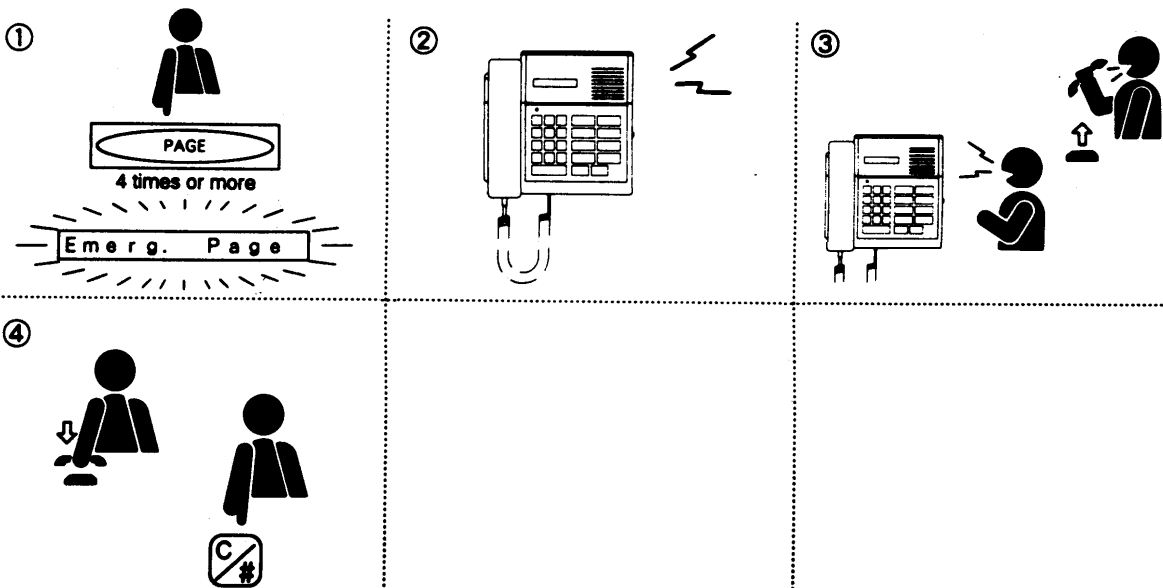

● Confirmation, repaging and registered area deletion

The last paged paging area is automatically stored in memory, permitting repaging of the same area via a simple key operation. The stored paging area can also be displayed for confirmation or deleted from memory.

- ① To display, press [PAGE] key.
To check for other undisplayed output areas, press [DISPLAY CALLS] key.
- ② To repage, press [PAGE] [PUSH TO TALK] keys.
- ③ To delete, press [PAGE] [*] [PUSH TO TALK] keys.

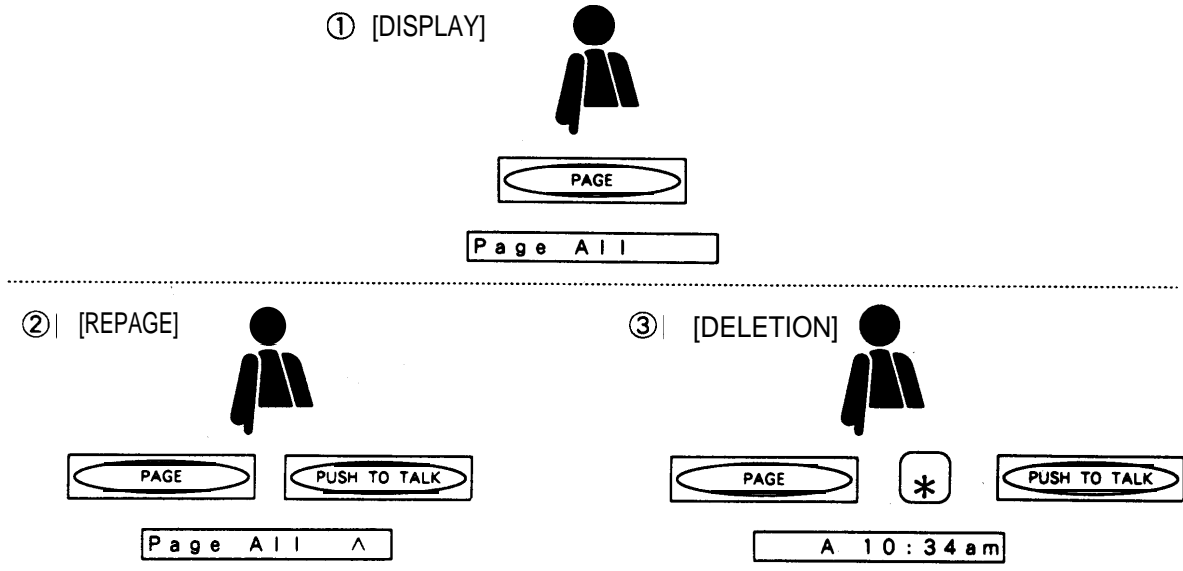

(6) PA Paging

The IC-100 system is provided with one dedicated audio signal output for paging through a connected external PA system. An additional two-bit control output permits signal assignment to up to three different external PA zones, which can be selected with the installation of an auxiliary selection device.

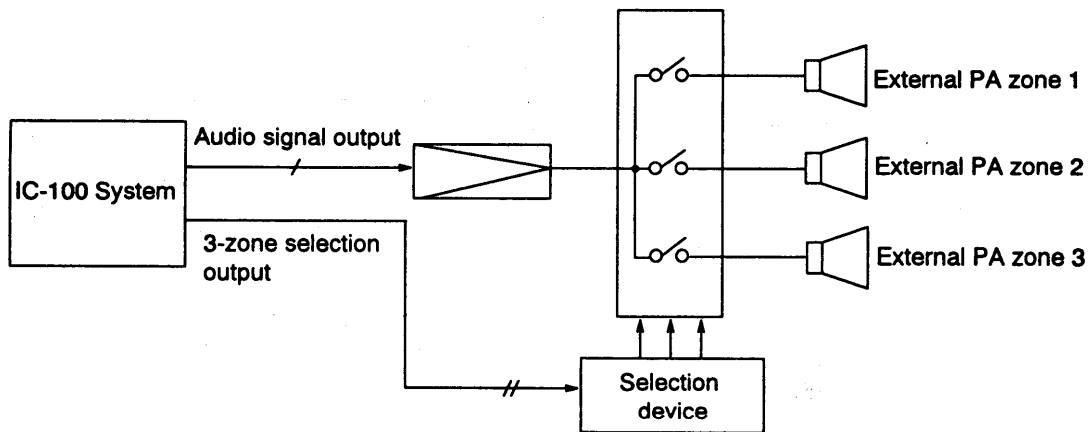

To enable this function, the desired PA paging zone must be assigned to the corresponding station paging zone by system programming.

[Paging Dial Operation Example 1]

Ext. PA Zone	Station Paging Zone	Dialing Operation
1	Zone 1 Paging	PAGE ZONE 1 PTT
2	Zone 2 Paging	PAGE ZONE 2 PTT
3	Zone 3 Paging	PAGE ZONE 3 PTT

<Explanation> Pressing [PAGE] [ZONE] [1] [PTT] simultaneously pages both station paging zone 1 and PA zone 1.

[Paging Dial Operation Example 2]

Ext. PA Zone	Station Paging Zone	Dialing Operation
1	Zone 1 Paging	PAGE ZONE 1 PTT
2	Zone 2 Paging	PAGE ZONE 2 PTT
1 and 2	All-Call Paging	PAGE ALL PTT

[Paging Dial Operation Example 3]

<Explanation> Pressing [PAGE] [ALL] [PTT] simultaneously pages all station paging zones as well as PA paging zones 1 and 2.

Ext. PA Zone	Station Paging Zone	Dialing Operation
1	Combination Zone 1 Paging	PAGE 1 PTT
2	Combination Zone 2 Paging	PAGE 2 PTT
3	Combination Zone 3 Paging	PAGE 3 PTT

[Note]: (1) [PTT] : [PUSH TO TALK] key

(2) Only one paging zone must be selected, as shown in the examples above.

When more than one paging zone is selected simultaneously, external PA paging is only possible for the zone selected first.

<Example>

[PAGE] [ZONE] [1] [2] [PUSH TO TALK]

Zone No.1 : PA paging provided.

Zone No.2 : PA paging disabled. (Station paging still possible.)

(7) External Microphone All-Call Paging

All-call paging can be performed from a connected external microphone after activation with an external switch.

(8) Number of Zones

Up to nine paging zones (No.1-9) can be established for a single-digit system, and up to 60 zones (No.01 -60) can be established for a double-digit system. (Note that zone No.60 is also used for broadcasting time signals to “all zones under the “time schedule” and “external time signal trigger” functions, making the virtually available number of paging zones 59 for a double-digit system.)

(9) Temporary Station Output Disable

Individual stations can be temporarily designated not to receive control station paging output. This function has three selectable modes;

(9.1) Disable mode

① Total output disable

Totally omits stations from their assigned broadcast zones, with no access to outputs from any control station in the system.

② Limited output disable (Without automatic reset)

Omits stations from their registered control station output.

Output from other control stations can still be received. (Remains in effect until cancelled by a dialing operation.)

③ Limited output disable (With automatic reset)

Omits stations from their registered control station output.

Output from other control stations can still be received. (Automatically cancelled with voice or signal tone transmission.)

[Note] : The Station Output Disable function is not operated (designated stations receive output) when any of the following paging is made:

- (1) Emergency all-call paging
- (2) External microphone all-call paging
- (3) PBX station paging

(9.2) Output disable registration

<Registration>

The specified stations can be temporarily omitted from their assigned paging zones by the following registration.

* PAGE PUSH TO TALK
Station No. to omit Station No. to omit
Max. 4 stations

<Cancellation>

The stations temporarily omitted can be restored to their assigned broadcast zones by the following dial operation.

* PAGE PUSH TO TALK

[Note]: When "Limited Output Disable (With automatic reset)" mode is set, no dial operation of cancellation is required.

<Confirmation of Registered Stations>

* PAGE DISPLAY CALLS

To check for other undisplayed station,

DISPLAY CALLS

(9.3) Output disable indication

When omitting stations from their registered station output, the "\$" indication is displayed on the control station at the paging dial operation.

<Example>

- (1) **PAGE** **ALL** **PUSH TO TALK**
 (2) **PAGE** **ZONE** **1** **2** **3** **4** **PUSH TO TALK**
 (3) **PAGE** **1** **2** **3** **4** **PUSH TO TALK**

P	a	g	e	\$	A	I	I	Λ		
P	a	g	e	\$	Z	1	2	3	4	Λ
P	a	g	e	\$	C	1	2	3	4	Λ

(10) Summary of Paging Operation

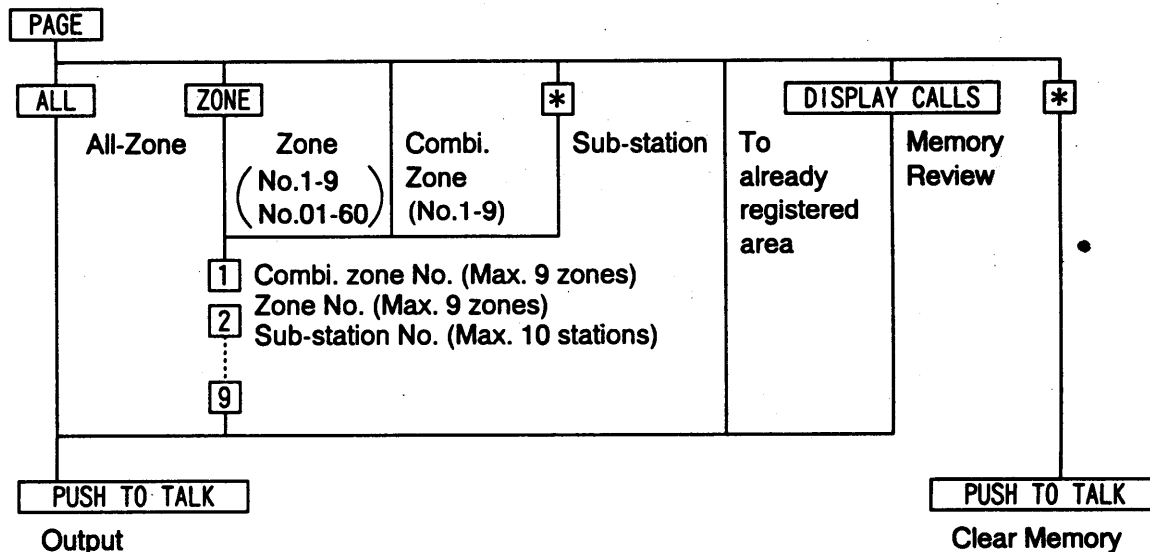

(11) Transmission Priority List

- ① Emergency all-call paging *1
- ② Emergency call
- ③ All-call paging/External microphone all-call paging *2
- ④ Zone/Combination zone *2
- ⑤ Conversation (including unanswered calls)

[Note]: *1: Overridden lower priority functions not restored, even after function completion.

*2: Overridden lower priority functions restored after function completion.

(12) Dial Operation While Being Paged

(12.1) Emergency all-call paging

Dialing cannot be performed from the station that is receiving Emergency all-call paging.

(12.2) Other paging

Dialing can be performed even while the station is being paged, if it is not Emergency all-call paging. The original paging is automatically restored after call completion.

SECTION 3. CONVENIENT CONTROL STATION FUNCTIONS

3.1 Applicable to Both Internal and Outside Calls

(1) Redialing

Press [REDIAL] key to automatically call the last dialed number.

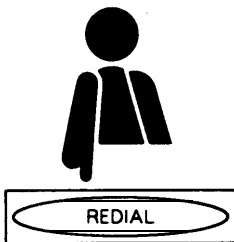

Redialing, however, cannot be performed with the [DISPLAY CALLS], [PRIORITY], [*], or [C/#] key.

(2) Speed Dialing [Selectable Function]

Press one or two numerical keys to dial the pre-programmed number.

● Key Operation

Single-digit dialing:

2-digit dialing:

is a number determined at the time of installation.

is a user programmable number (0 through 9).

A maximum of 10 speed dialing numbers can be registered per control station in 2-digit dialing, or only one in single-digit dialing.

● Speed Dialing Registration

(1) Single-digit dialing : ... Confirmation tone

(2) 2-digit dialing : ... Confirmation tone

: Function registration selection

: Pre-determined number

: User programmable number (0 through 9)

: Dialing (numerical key) or other function (function key) data, Max. 32 digits, excluding , , and .

(3) Call Transfer

When two parties are talking, either party can be placed on hold to permit the calling of a third party for possible call transfer.

- ① Dial the third party's station number.
(If on an outside line or PBX extension, dial the [PUSH TO TALK] key and the third party's station number.)
If on an outside line or PBX extension, the second party is temporarily placed on hold and a hold signal is heard as the third party is called. If on an internal line, no hold tone will be heard at the second party's station.

- ② Talk with third party (If there is no answer from the third party, the original conversation is resumed by pressing the [*] key.)

- ③ To connect the second party with the third party, press [C/#] key. (The previous conversation is terminated.)

Replacing the third party's handset restores contact with the second party, thus terminating the conversation with the third party.

[Note]: (1) Calls can only be transferred to stations having a handset.

- (2) The sub-station handset placed on hold remains held regardless of whether or not its handset is replaced.

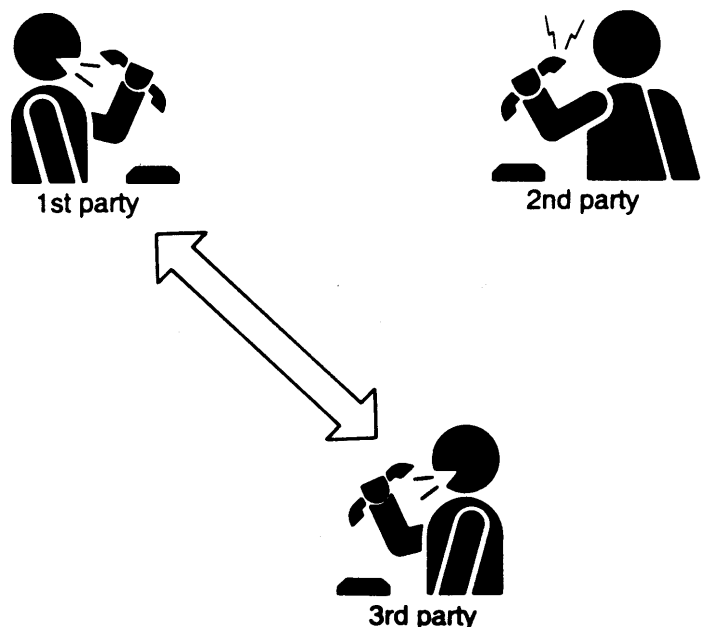
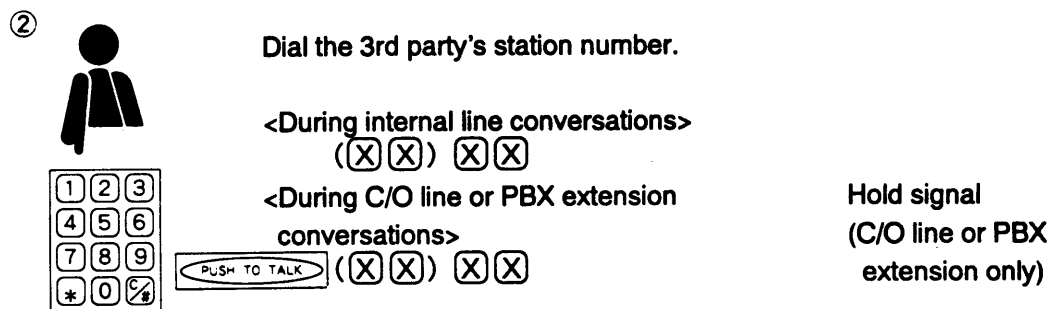
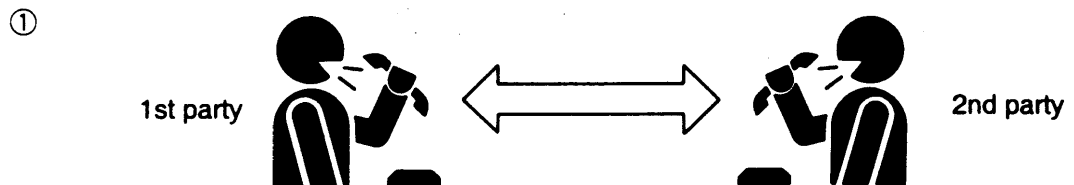

③



To connect the 2nd party with the 3rd party.

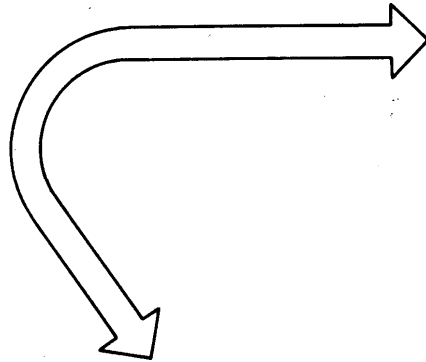

Restores contact with the 2nd party.
(Only possible when the 3rd party puts down his handset.)

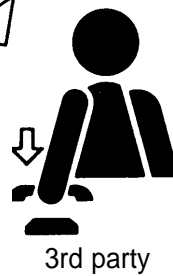
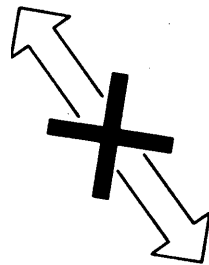
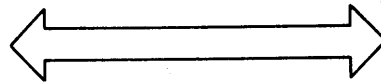

Restores contact with the 2nd party.

(4) Call Forwarding

This function permits all incoming calls to be automatically rerouted to other station registered at the called station.

Registration

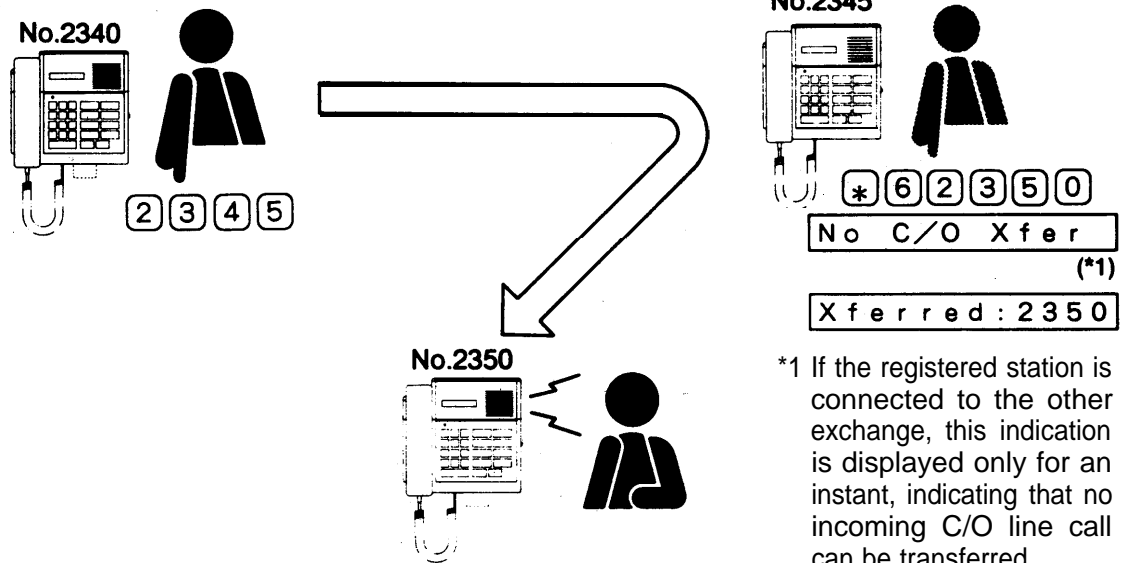

Cancellation

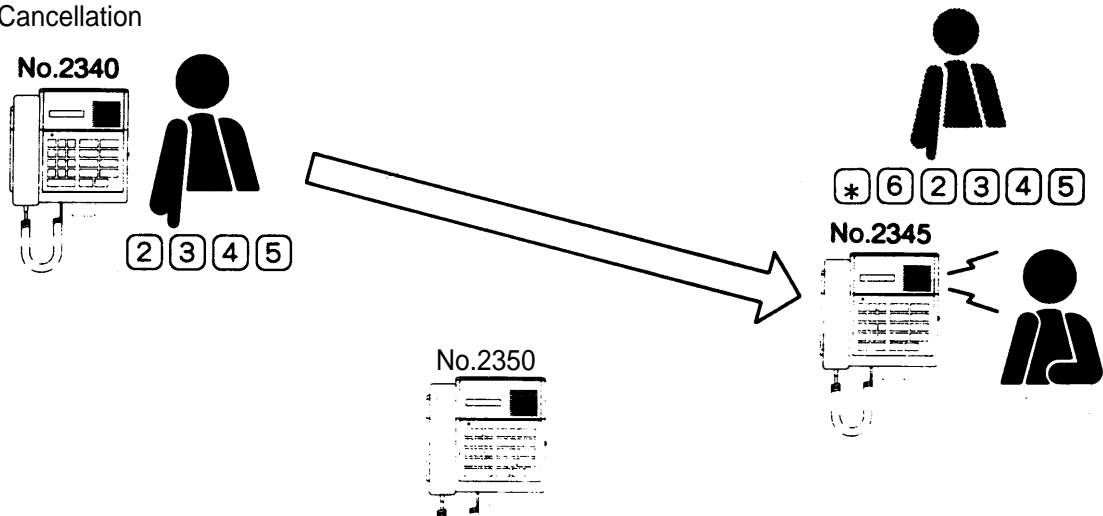

- [Note]:** (1) The station to which calls are to be forwarded must be a control station.
 (2) All incoming regular station calls can be rerouted to any control stations registered for the Call Forwarding function.
 (3) If the registered control station is connected to the other exchange, incoming C/O line calls are connected to the original station without being rerouted.

● Call Forwarding Registration & Cancellation

<Registration> : * 6 (X X) X X
 Forwarding station number

<Cancellation> : * 6 (Y Y) Y Y
 Original station number

(5) Auto-Call C/O Transfer [Selectable Function]

This function permits handset sub-station calls to a control station registered for this function to be automatically forwarded to a programmed C/O telephone number.

● Transfer Registration

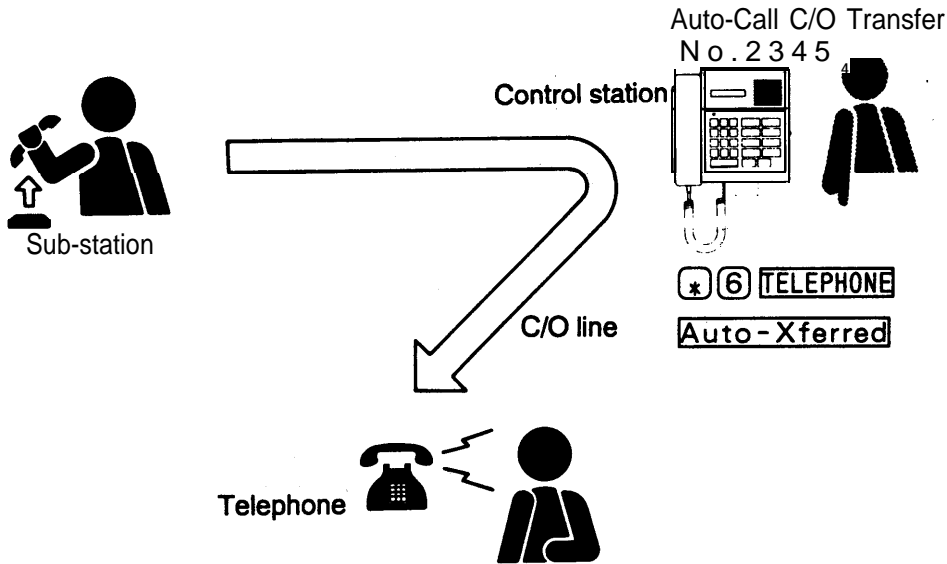

● Transfer Cancellation

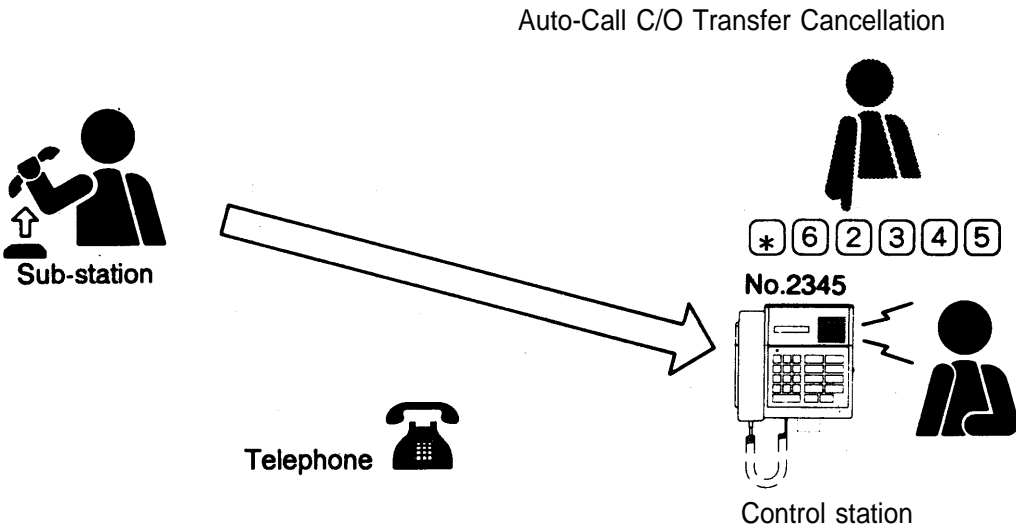

<Auto-Call C/O Transfer Registration>

* 6 TELEPHONE

<Auto-Call C/O Transfer Cancellation>

* 6 (X X) X X

(XX) XX: (Original station number)

<Handset Sub-Station Operation>

- ① Lift the handset.
[CALL] key operation is unnecessary.
- ② Replace the handset if the C/O telephone line is busy. The call is retransmitted when the handset is lifted again.
- ③ Emergency call operation (which is normally enabled by pressing the call button for more than three seconds) is disabled.

[Note]: (1) Auto-call C/O transfer telephone numbers must be pre-programmed for the system.

(2) Auto call C/O transfer applies only to handset sub-station calls. Calls from other control stations and the incoming C/O line can still be directly made to the control station, regardless of its auto-call transfer setting.

(3) Control stations not directly connected to an exchange set-up with the C/O line interface have no access to this function.

● External Controls for Auto-Call C/O Transfer

- (1) In addition to control station dialing operations, the auto-call C/O transfer function can be activated by controlling the exchange's external make contact inputs with an external timer, etc.
- (2) The external make contact inputs enable auto-call C/O transfer for control station No.15 (AS1) and/or No.31 (AS2).
- (3) When auto-call C/O transfer is externally enabled, it cannot be cancelled with a control station dialing operation.

<MU-110 External Auto-Call C/O Transfer Control>

Make Contact Input	Function 1	Function 2
CN7-3	External time signal control 5	Control station No.15 (AS1) auto-call C/O transfer
CN7-4	External time signal control 6	Control station No.31 (AS2) auto-call C/O transfer

These two make-contact inputs can be used for either Function 1 or 2, depending upon system programming.

3.2 Internal Line Calls

(1) Selective Response

(1.1) Incoming calls to an unused control station

The station Nos. of all stations simultaneously calling an unused control station are automatically stored, with the highest priority station No. indicated on its display. When more than one station is waiting, as indicated by suffix "M", the other waiting station numbers can be displayed with subsequent depressions of the [DISPLAY CALLS] key. To answer, advance the display to the desired station No. and press the [PUSH TO TALK] key or lift the handset.

[Note] :(1) Waiting stations are arranged in priority order, with those having the same priority displayed on a first-come-first-served basis.

(2) The display returns to its initial status after the last of the waiting stations is displayed with the [DISPLAY CALLS] key, or when the [C/#] key is depressed.

[Example]

KEY OPERATION	DISPLAY	STATUS
①	1234N	(No.1234 calling.)
②	1234N M	(No.2345 calling.)
③	1234N M	(No.3456 calling.)
④ [DISPLAY CALLS]	2345N: 1/ 2	
⑤ [DISPLAY CALLS]	3456N: 2/ 2	
⑥ [PUSH TO TALK]	3456N:1234NM	(Automatically connected to No.3456)

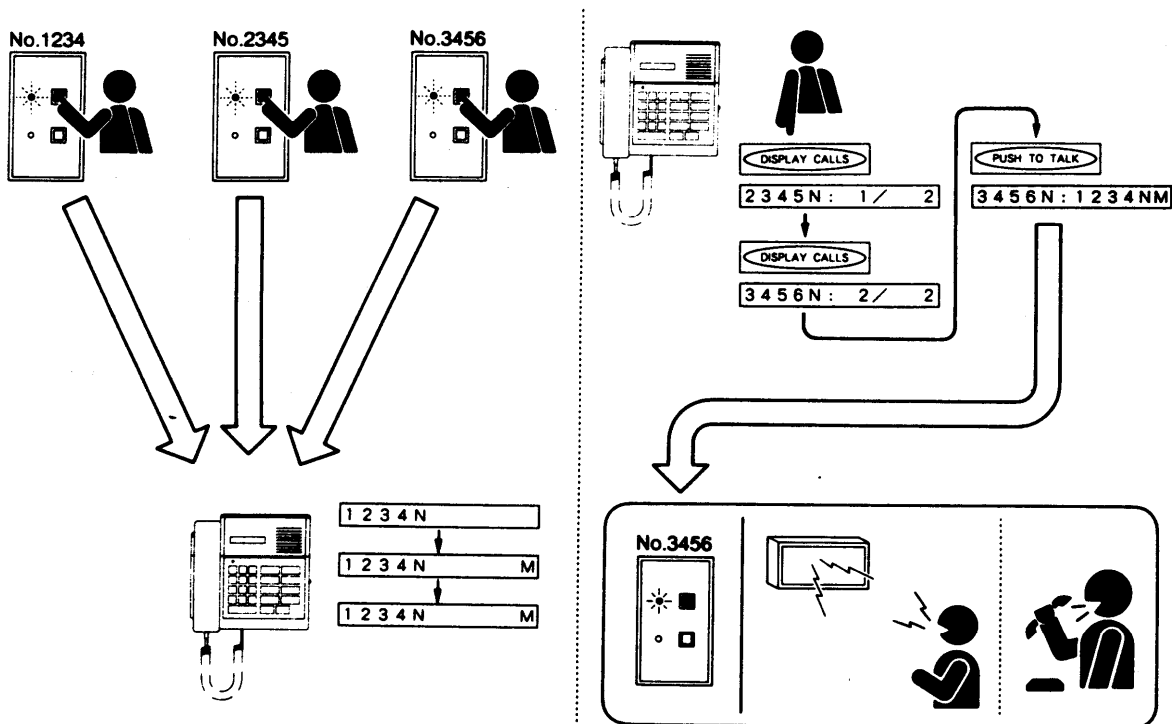

(1.2) Incoming calls to a busy control station

When a busy control station is called from more than one station, only the currently connected station and one waiting station are displayed. The other waiting stations are indicated by a letter "M" and displayed in turn with depression of the [DISPLAY CALLS] key.

To answer, first terminate the current conversation, then advance the display to the desired station No. before pressing the [PUSH TO TALK] key or lifting the handset. Simply displaying the desired station No. during conversation does not permit the connection to that station even after conversation completion because the display returns to the original status when the conversation is terminated.

[Note]: Incoming calls from an outside line can also be stored. When there is an outside line call to a busy control station, the message "C/O Line" is displayed. Once the [DISPLAY CALLS] key has been pressed to display other waiting stations during conversation, the message can no longer be displayed with the [DISPLAY CALLS] key. It can be displayed only when the current conversation is terminated.

[Example]

KEY OPERATION	DISPLAY	STATUS
①	1234N	(Talking with No.1234.)
②	1234N: 2345N	(No.2345 calling.)
③	1234N: 2345NM	(No.3456 calling.)
④ [DISPLAY CALLS]	3456N: 1/ 1	
⑤ C/# (*1)	1234N: 2345NM	(Return to initial display.)
⑥ C/#	2345N M	(Terminate No.1234 conversation.)
⑦ [DISPLAY CALLS]	3456N: 1/ 1	
⑧ [PUSH TO TALK]	3456N: 2345N	(Connect No.3456.)

[Note]: (*1) Replacing the handset terminates the original conversation.

(1.3) Incoming call during paging

[Example]

KEY OPERATION	DISPLAY	STATUS
①	A 11:50am	(Page received.)
②	1234N	(No.1234 calling.)
③	1234N M	(No.2345 calling.)
④ [DISPLAY CALLS]	2345N: 1/ 1	
⑤ [PUSH TO TALK]	2345N: 1234N	(Disconnect from paging; connect to No.2345.)

(1.4) Incoming outside C/O line call

[Example]

KEY OPERATION	DISPLAY	STATUS
①	C/O Line	(Call received from outside line.)
②	C/O Line M	(No.1234 calling)
③ DISPLAY CALLS	1234N: 1/ 1	
④ PUSH TO TALK	1234N	(Connect to No.1234.)

(1.5) Incoming outside C/O call during internal conversation

[Example]

KEY OPERATION	DISPLAY	STATUS
①	1234N	(Talking with No.1234.)
②	C/O Line	(C/O line calling)
③	C/O Line M	(No.2345 calling)
④	C/O Line M	(Terminate No.1234 conversation.)
⑤ Lift handset.	C/O Line M	(Connect to C/O line.)

(2) Conference [Selectable Function]

"Conference" conversations can be held with up to three parties if each station is equipped with a handset.

KEY OPERATION

- ① Press [CONFERENCE] key, then dial the 2nd party's station number.
- ② Tell the 2nd party on the conference.
- ③ Dial the 3rd party's station number.
- ④ Three-party conference conversation possible.
- ⑤ The conference is terminated if one of participants (must be the control station) puts down his handset or presses [C/#] key.

DISPLAY

Conf:1234

C:1234:

Conf:3456

C:1234:3456

- [Note] :** (1) Conference calls can also be initiated during regular station-to-station conversation by pressing [CONFERENCE] key and then dialing the third party. (In this event, the caller of the conversation must dial.)
If the conference began as a station-to-station conversation, the party first pressing the [CONFERENCE] key becomes the conference initiator.
- (2) Only the third party can drop out of the original conversation if the conference initiator presses the [*] key before the third party lifts handset.
 - (3) A call-in during conversation is displayed as [C:1234:3456M].
 - (4) When calling the third party, the first party's and second party's handsets must be both lifted.

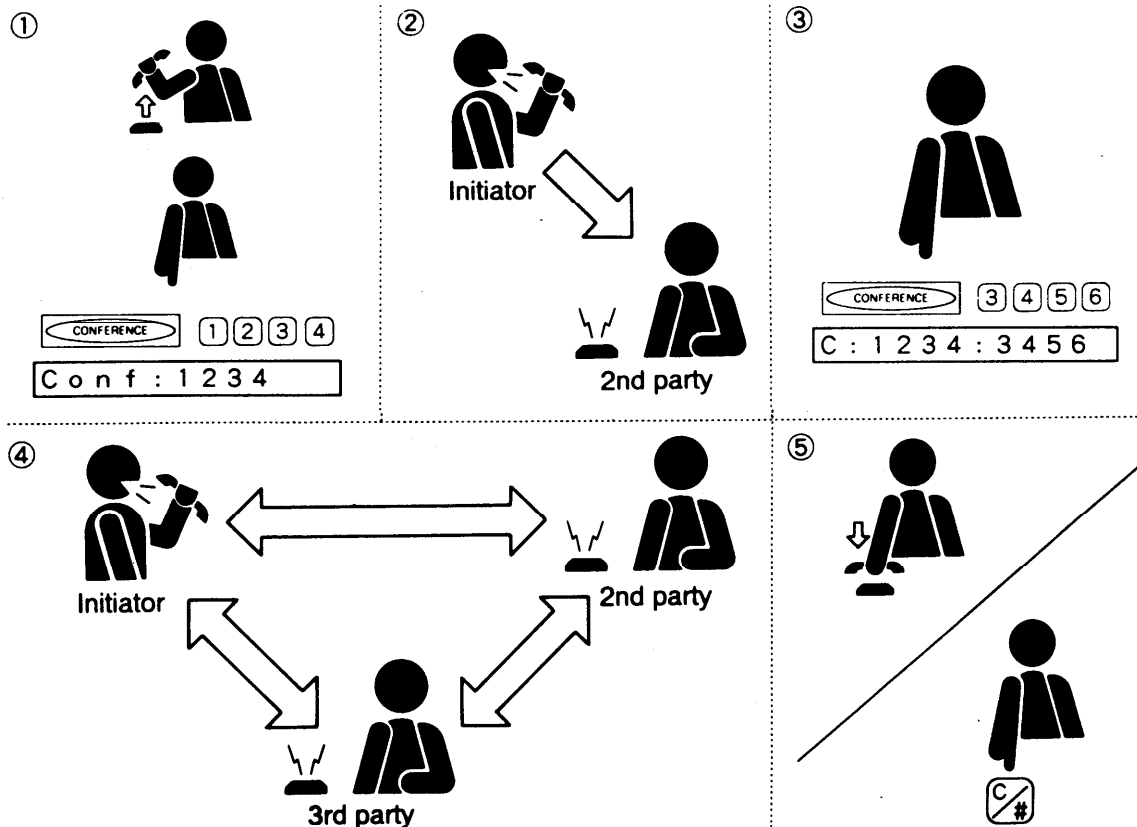

(3) Control Station Group Call [Selectable Function]

All control stations pre-programmed for the same group can be simultaneously called from a sub-station. When one of the control stations within the group answers the call, calls to the other control stations are automatically cancelled.

- Control Station Group Call

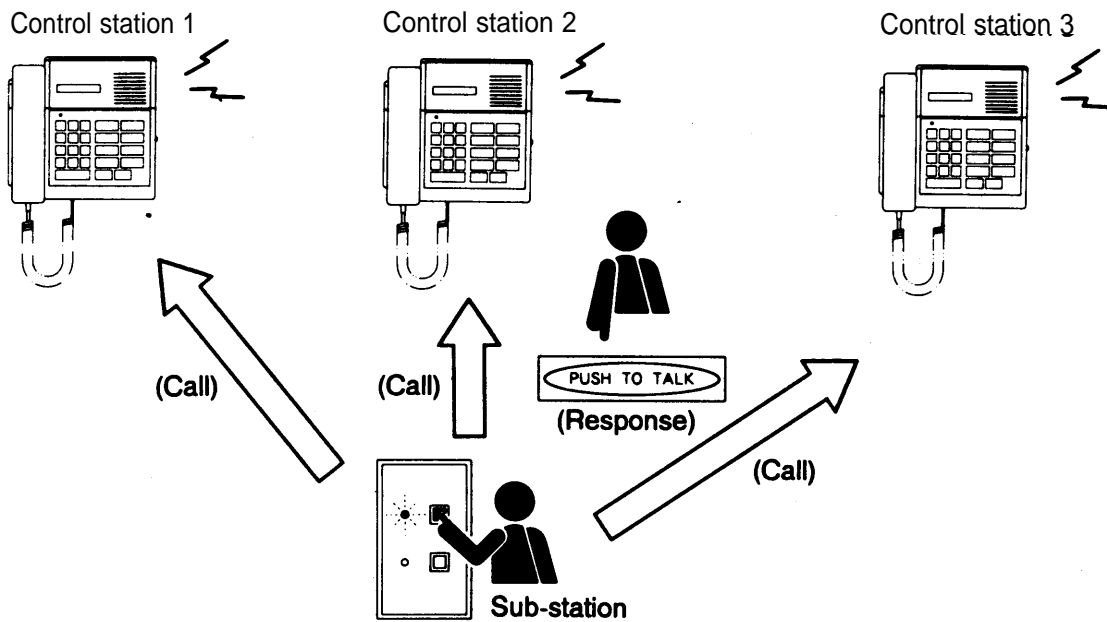

- Control Station Group Response

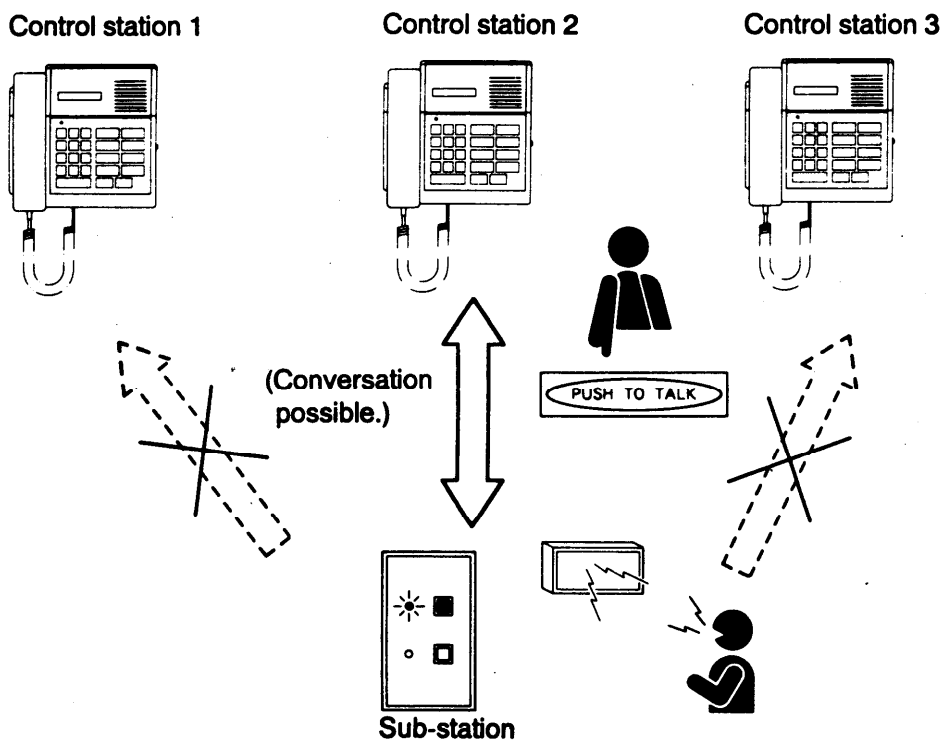

3.3 Scan Monitor

Any control station can scan an arbitrary group of sub-stations (in consecutive order) for auditory monitoring of each sub-station. Scanning can be performed automatically or manually.

(1) Automatic Scanning

(1.1) Scan monitor

Press ***** **2** **(X X) X X**, **(Y Y) Y Y**, **PUSH TO TALK**.

1st station No. Last station No.

Scanning automatically cycles through the sub-station group until manually stopped.

The last monitored stations are automatically stored in memory, permitting remonitor of the same stations via a simple key operation.

To remonitor, press ***** **2** **PUSH TO TALK**.

- [Note]** :
- (1) Control stations cannot be monitored.
 - (2) When a sub-station is busy, no sound is heard from that station when monitored.
 - (3) Unconnected sub-stations must be registered as "no connection" by system programming.
 - (4) "Scan monitor" function is not operated for five minutes after finishing the system programming ([REGISTER] switch to OFF.).

● Scan Monitor

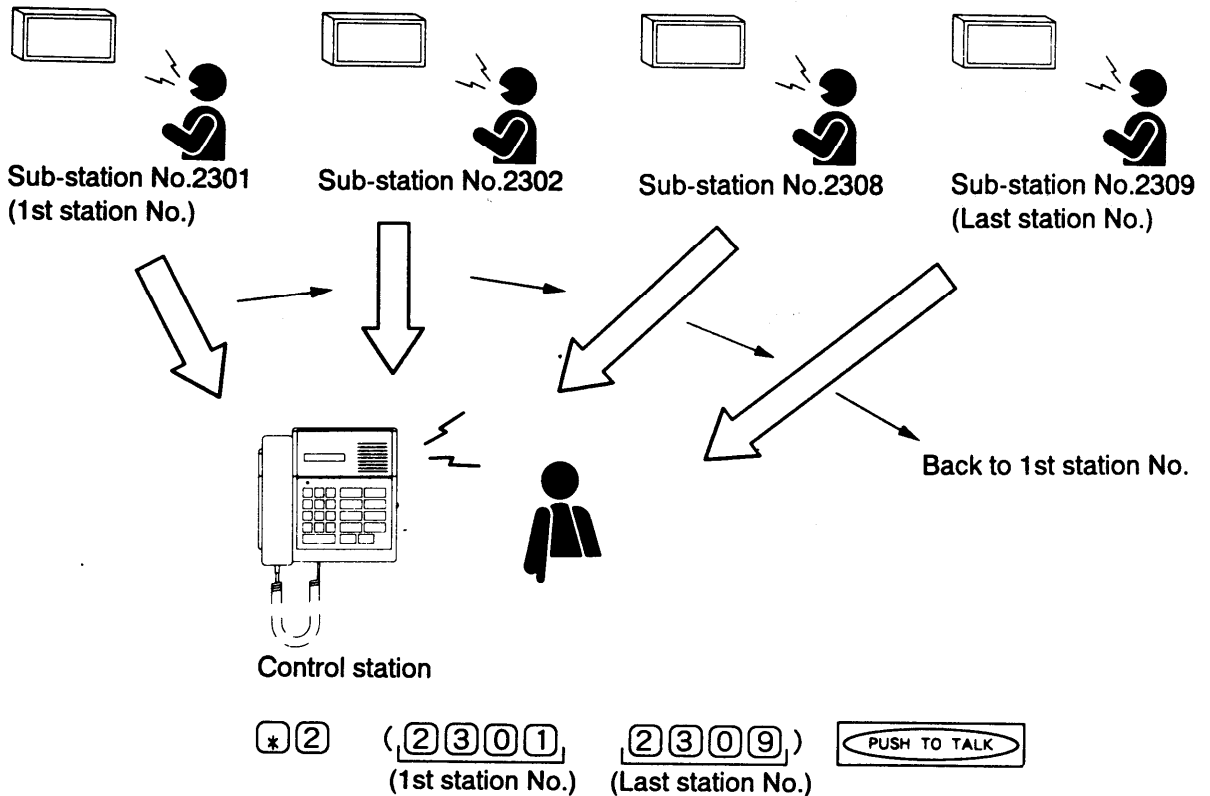

(1.2) Monitor interval registration

Sub-stations can be monitored at a variable interval of 1-9 seconds. (Preset to 1 second.)

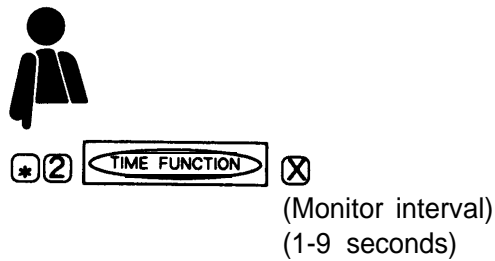

(1.3) Scan monitor cancellation

The scan monitor function can be canceled by either pressing the [C/#] key or replacing the control station handset.

(2) Manual Scanning

(2.1) Automatic scanning stop & restart

To monitor a particular station, press the [PUSH TO TALK] key to stop automatic scanning at that station. Pressing the [PUSH TO TALK] key again will restart the automatic scanning sequence.

(2.2) Scan FORWARD

Pressing the [ALL] key advances monitoring by one station.

(2.3) Scan BACK

Pressing the [ZONE] key reverses monitoring by one station.

<Manual Operation Keys>

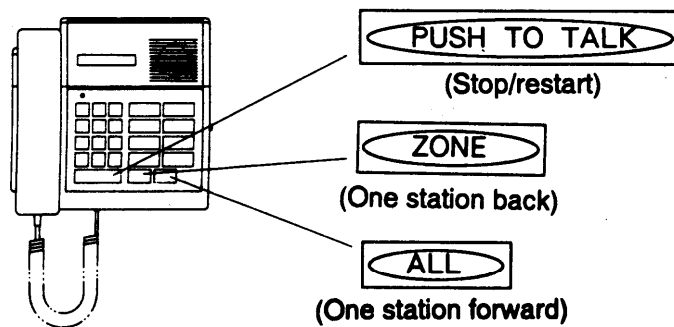

3.4 PBX Station Intercommunication [Selectable Function]

Stations can be connected to the PBX using the CT-100 C/O& tie-line card. The CT-100 features two outside C/O line terminals which can be registered for either C/O line or PBX extension use by system programming. Only one outside C/O line terminal may be connected to the PBX extension.

<System diagram>

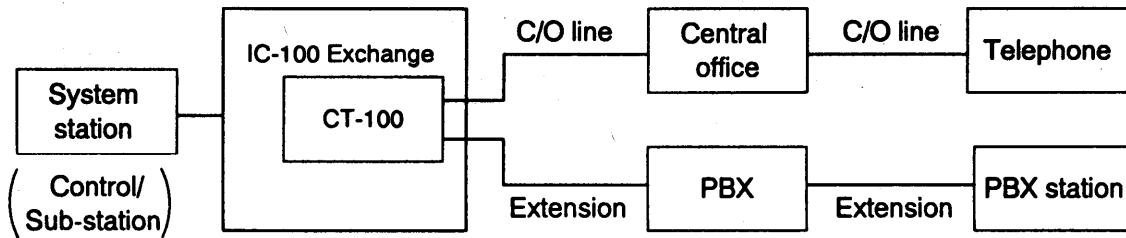

(1) System Station to PBX Station Calls

<Communication Flowchart>

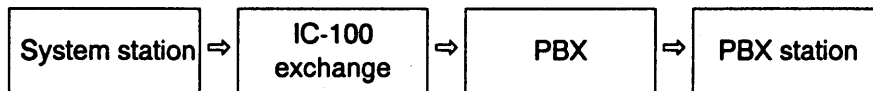

(1.1) Control station to PBX station calls

(1.1.1) Calling

- ① Press the [TELEPHONE] key. (*1) The PBX connection confirmation tone is heard.
- ② Dial the PBX station number. (Tel: 3401)
- ③ Call tone is heard. ④ Lift the handset. (The handset maybe lifted before dialing.)
- ⑤ Begin conversation. ⑥ Replace the handset to terminate the conversation.

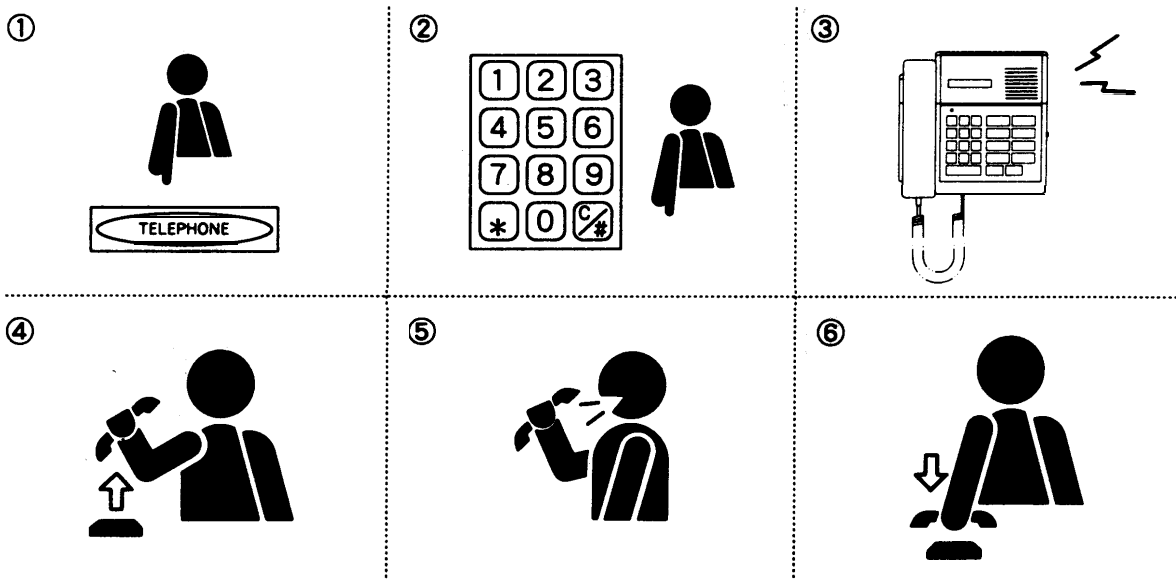

[Note] : (*1) For systems connected to both the C/O line and PBX, assign access numbers 1 and 2 to distinguish between the two.
(Ex.: [TELEPHONE] [2] for PBX station calls.)

(1.1.2) Being called

- ① The PBX connection confirmation tone is heard.
- ② Conversation can proceed by lifting up the handset.
- ③ Replace the handset to terminate the conversation.

(PBX Line)

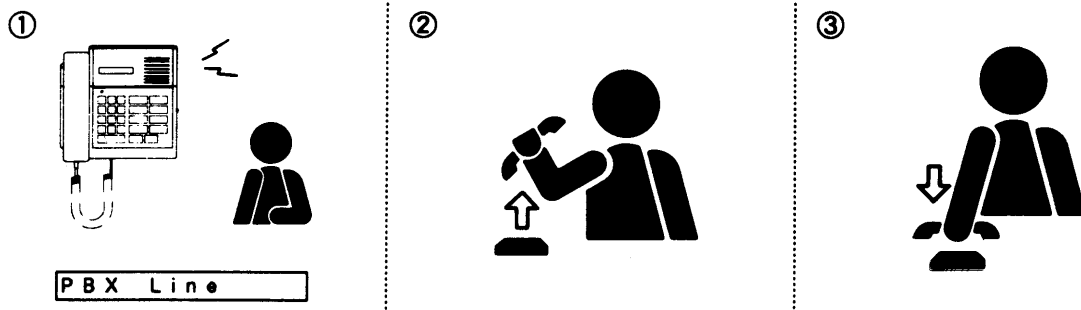

(1.2) Sub-station to PBX station calls

(The master/sub relationship of the sub-station and desired PBX station must be established in advance by system programming.)

- ① Lift the handset, and the PBX connection confirmation tone is heard. (The handset may also be left on the cradle and the [CALL] button pressed, enabling voice-actuated conversation to be initiated from the PBX station.)
- ② Call tone is heard.
- ③ The called party lifts the PBX station handset.
- ④ Begin conversation.
- ⑤ Replacing the sub-station handset terminates the conversation. Termination from the PBX station can only be accomplished by first pressing them key and then replacing the handset.

[Caution] : (1) Once the PBX station handset has been replaced without first pressing the [#] key, the conversation can no longer be terminated from the PBX station until the PBX conversation time-out function is operated.

(2) The conversation cannot be terminated from the sub-station unless its handset is used.

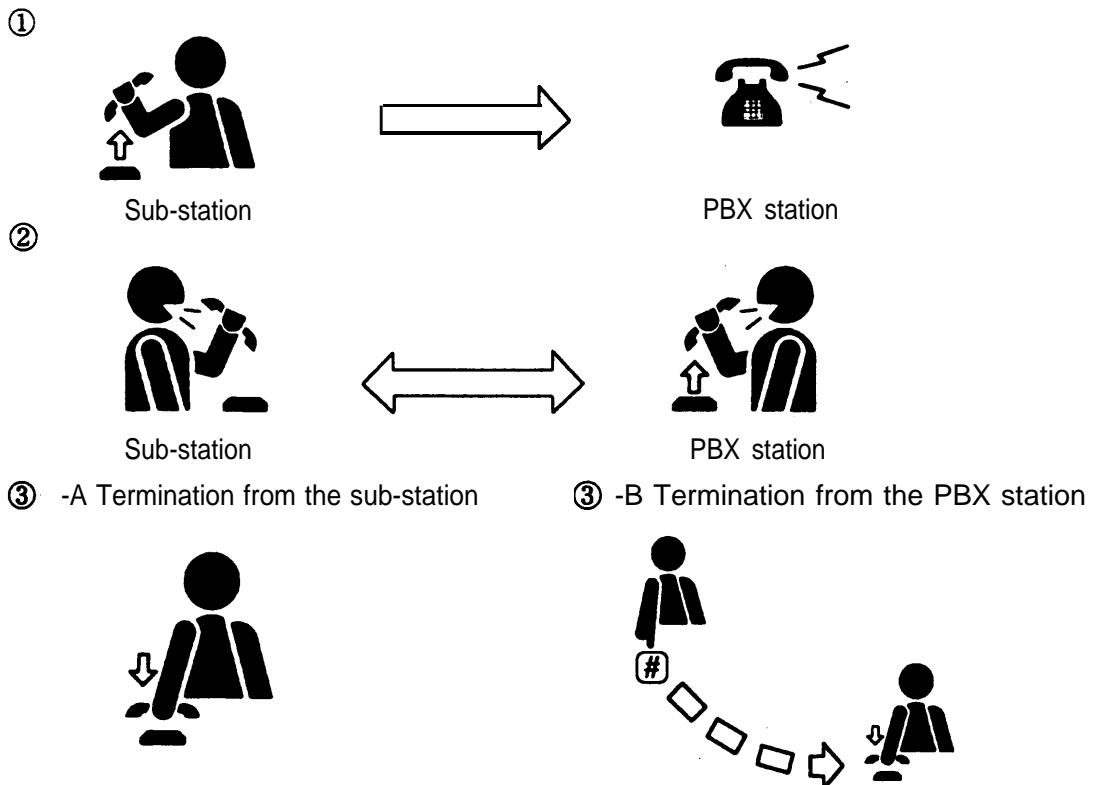

Press the [#] key before replacing the handset.

(2) PBX Station to System Station Calls

<Communication Flowchart>

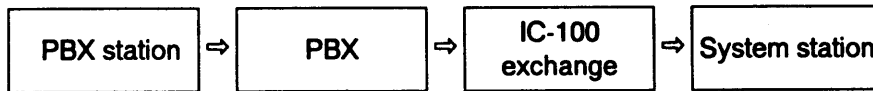

(2.1) PBX station to control station calls

(2.1.1) Calling

- ① Replace the handset.
- ② Dial the designated extension access number (i.e. the PBX extension number assigned to the IC-100 exchange).
- ③ Dial the control station number.
- ④ (The called party lifts the station handset.)
- ⑤ Begin conversation.
- ⑥ Press the [#] key and replace the handset to terminate the conversation.

①



②

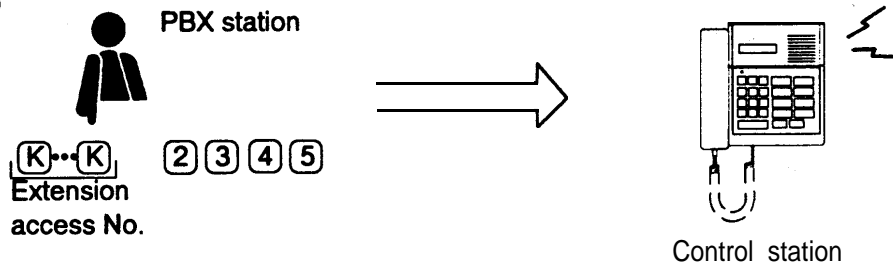

③

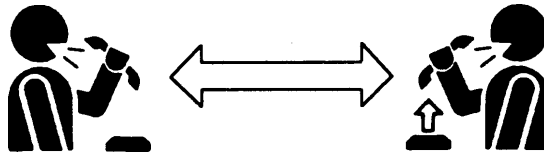

④ -A Termination from the PBX station

④ - B Termination from the control station

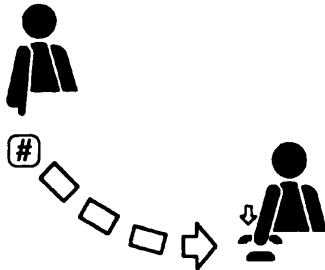

[Note] : Always be sure to press the [#] key before replacing the PBX station handset, regardless of where the call is initiated.

(2.2) PBX station to sub-station calls

- ① Lift the handset.
- ② Dial the designated extension access number (i.e. the PBX extension number assigned to the IC-100 exchange).
- ③ Dial the sub-station number.
- ④ Begin conversation after a brief calling tone stops. Conversation flow is regulated by a voice-actuated switch that permits only one-way transmission when speaking into the PBX station. Sub-station voice transmission is only possible when the PBX station is silent.
- ⑤ Full-duplex (simultaneous two-way) communication is made possible by lifting the sub-station handset.
- ⑥ To terminate the conversation at the PBX station, press the [#] key and then replace the handset regardless of where the call is initiated.

[Caution] : (1) Once the PBX station handset has been replaced without first pressing the [#] key, the conversation can no longer be terminated from the PBX station until the PBX conversation time-out function is operated.

(2) The conversation cannot be terminated from the sub-station unless its handset is used.

①

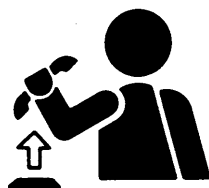

PBX station

②

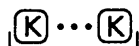

Extension
access No.

2 3 4 5

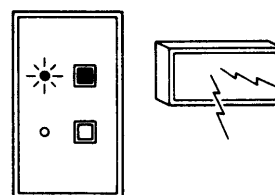
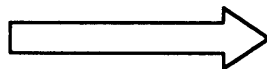

Sub-station

③



PBX station

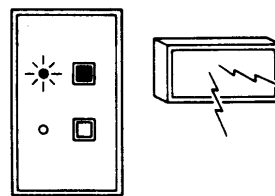
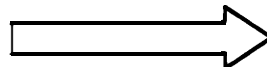

Sub-station



④



PBX station

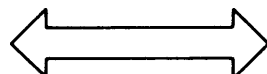

Sub-station

<Combination Zone Paging>

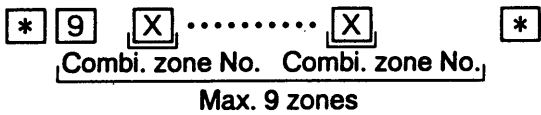

④ Paging may begin following pre-announcement tone output.

⑤ To terminate paging, press the [#] key, then replace the handset.

[Caution]: Once the PBX station handset has been replaced without first pressing the [#] key, the conversation can no longer be terminated from the PBX station until the PBX conversation time-out function is operated.

①



②

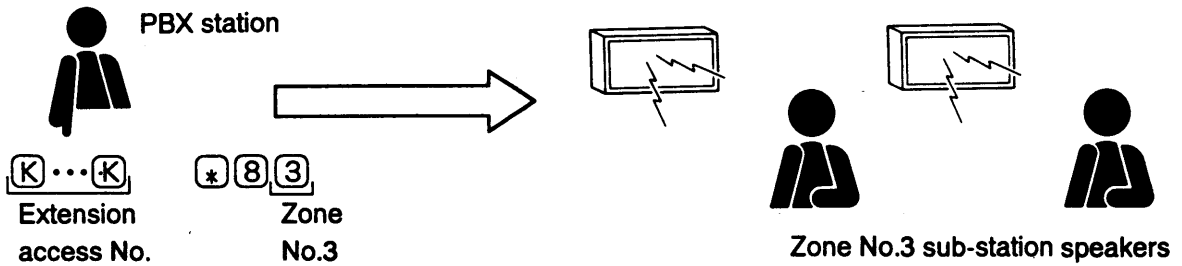

③

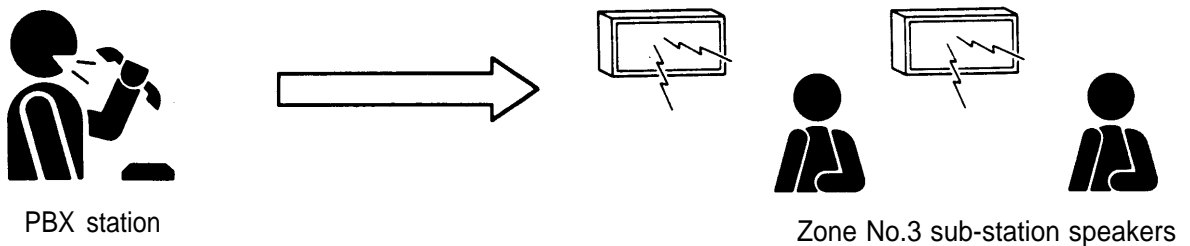

④

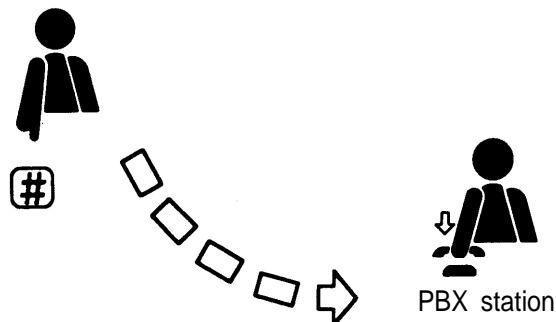

[Note]: Be sure to press the [#] key before replacing the handset.

SECTION 4. AUXILIARY FUNCTIONS AND OPERATING PRECAUTIONS

4.1 Time Setting and Adjustment

(1) Time Setting [Unrestricted Control Station Only]

Current time is set by pressing .

: 00~23 (hour), : 00~59 (minute)
[24-hour mode only]

: Second synchronization

(2) 12-/24-hour Mode Switching

Current time can be displayed in either 12-hour or 24-hour mode. Entering [*] [5] [PUSH TO TALK] automatically toggles between the two modes.

(3) Second Synchronization

[Example]

KEY OPERATION

DISPLAY

① Enter

Time display 13:45:27

② Press the key.

Second display reset to "00".

③ Press the key.

Display returns to original time display mode.

Second count 0-30 : Zero reset to same minute.

Second count 31-59 : Zero reset to next minute.

[Note]: Zero reset can be performed as often as necessary with subsequent depressions of the [PUSH TO TALK] key.

4.2 Station Priority Registration and Calling [Unrestricted control stations only]

As described in "Section 2.2 (6) Sub-station Display Priorities" any one of three priorities ("Alarm", "Normal" and "Staff") can be assigned to each sub-station. Basically these priorities are determined at the time of system programming. However, the higher "Priority" level than "Alarm", "Normal" and "Staff" level can be temporarily registered at the control station assigned to the sub-stations its level is registered to.

(1) Registration

KEY OPERATION

DISPLAY

- ① **PRIORITY** (Enters into Registration Mode)
- ② **1** **2** **3** **4** (Sub-station number entry)
- ③ **PUSH TO TALK** (Determination)

Prio:
Prio: 1234N
Prio: 1234P

"Priority" level is registered.

[Note]: Registration will be completed one second after depression of [PUSH TO TALK] key, whether or not [C/#] key is depressed.

(2) Cancellation

KEY OPERATION

DISPLAY

- ① **PRIORITY** (Enters into Registration Mode)
- ② **1** **2** **3** **4** (Sub-station number entry)
- ③ **PUSH TO TALK** (Determination)

Prio:
Prio: 1234P
Prio: 1234N

Originally designated priority level ("N") is resumed.

(3) Reviewing the Registered Stations and Call to Them

KEY OPERATION

DISPLAY

- ① **PRIORITY**
- ② **DISPLAY CALLS**
- ③ **DISPLAY CALLS**
- ④ **DISPLAY CALLS**
- ⑤ **PUSH TO TALK** (Automatically connected to No.6789)
- ⑥ **C/#** (Conversation termination)

Prio:
Prio: 1234P
Prio: 2345P
Prio: 6789P

4.3 Time Signal [Selectable Function]

This function sounds a time signal either automatically at pre-programmed times determined by one of two preset time schedules, or manually at any desired time.

(1) Time Schedule Selection (Automatic output) [Unrestricted Control Station Only]

Select Schedule A to H, or Output Stop. The system is factory-preset to Output Stop.

- | | | | | | |
|---|---|---|---|--------------|--------------------------|
| ① | * | 3 | 0 | PUSH TO TALK | (Output Stop) |
| ② | * | 3 | 1 | PUSH TO TALK | (Schedule A) |
| ③ | * | 3 | X | PUSH TO TALK | (Schedule A~H Selection) |
- Schedule code 1 : Schedule A, 2 : Schedule B, 3 : Schedule C, 4 : Schedule D
 5 : Schedule E, 6 : Schedule F, 7 : Schedule G, 8 : Schedule H

(2) Manual Output

Time signals can be manually initiated.

(2.1) All-zone output

- ① Press the **TIME FUNCTION** key.
- ② Press the **ALL** key.
- ③ Press the **PUSH TO TALK** key.

Time All ^

All-zone signal output

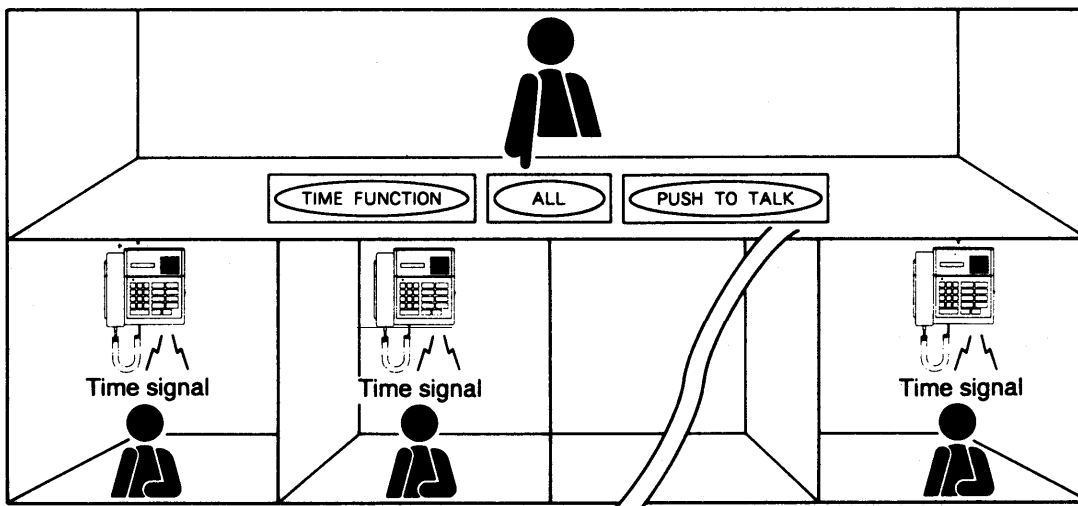

(2.2) Zone output

- ① Press the **TIME FUNCTION** key.
- ② Press the **ZONE** key.
- ③ Enter Zone No. (i.e. **2** **4** **6**) (Max. 9 zones can be selected simultaneously.)
- ④ Press the **PUSH TO TALK** key.

Time Z 2 4 6 ^

Signal output to designated zones 2, 4, and 6.

(2.3) Combination zone output

- ① Press the **TIME FUNCTION** key.
- ② Enter Combination Zone No. (i.e. **1** **2** **3**)
- ③ Press the **PUSH TO TALK** key.

T i m e C 1 2 3 ^

Signal output to designated Combination Zones 1, 2, and 3.

(2.4) Sub-station output

- ① Press the **TIME FUNCTION** key.
- ② Press the ***** key.
- ③ Enter sub-station No. (Max. 10: i.e. **2** **0** **0** **1** **2** **0** **0** **2**)
- ④ Press the **PUSH TO TALK** key.

T i m e S 2 0 0 2 ^

Signal output to designated Sub-stations No. 2001 and No. 2002.

(2.5) Confirmation and re-output of registered programs

- ① Press the **TIME FUNCTION** key.
Designated signal output areas displayed. To check for other undisplayed output areas,
- ② Press the **DISPLAY CALLS** key.
Other designated signal output areas are displayed with subsequent depressions of the **DISPLAY CALLS** key.
- ③ Next,
Press the **PUSH TO TALK** key.
Start signal output to designated areas.

(2.6) Number of zones

Up to nine broadcast zones (No.1-9) can be established for a single-digit system, and up to 60 zones (No.01 -60) can be established for a double-digit system. (Note that zone No.60 is also used for broadcasting time signals to all zones under the "time schedule" and "external time signal trigger" functions, making the virtually available number of broadcast zones 59 for a double-digit system.)

(2.7) Temporary station output disable

Individual stations can be temporarily designated not to receive control station time signal output. This function has three selectable modes;

(2.7.1) Disable mode

- ① **Total output disable**
Totally omits stations from their assigned broadcast zones, with no access to outputs from any control station in the system.
- ② **Limited output disable (Without automatic reset)**
Omits stations from their registered control station output.
Output from other control stations can still be received. (Remains in effect until cancelled by a dialing operation.)
- ③ **Limited output disable (With automatic reset)**
Omits stations from their registered control station output.
Output from other control stations can still be received. (Automatically cancelled with voice or signal tone transmission.)

[Note] : The Station Output Disable function is not operated (designated stations receive output) when any of the following time signal output is made:

- (1) Time signal (Automatic Output)
- (2) External time signal trigger

(2.7.2) Output disable registration

<Registration>

The specified stations can be temporarily omitted from their assigned time signal zones by the following registration.

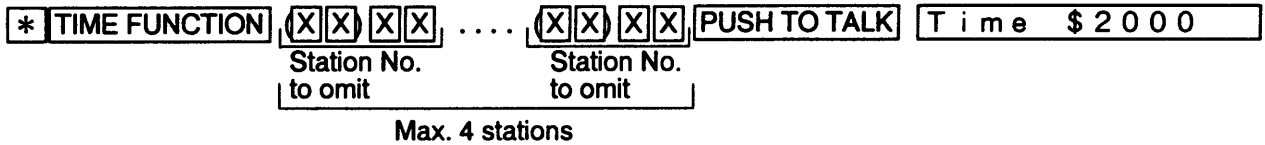

<Cancellation>

The control stations temporarily omitted can be restored to their assigned broadcast zones by the following dial operation.



[Note]: When “Limited Output Disable (With automatic reset)” mode is set, no dial operation of cancellation is required.

<Confirmation of Registered Stations>



To check for other undisplayed stations,



(2.7.3) Output disable indication

When omitting stations from their registered control station output, the “\$” indication is displayed on the control station at the time signal dial operation.

<Example>



(2.8) Changing sound source and external bell control settings

To change the system programming for the sound source and external bell control, press the [TIME FUNCTION] [Y] [Z] keys before pressing the [PUSH TO TALK] key.

- | | |
|------------------------------|-----------------------------|
| Y: 0 (No sound source) | 4 (Trill tone) |
| 1 (Long Westminster chime) | 5 (External sound source 1) |
| 2 (Medium Westminster chime) | 6 (External sound source 2) |
| 3 (Short Westminster chime) | 7 (External sound source 3) |

- Z: 0 (No external bell control)
 1 (External bell control)

Y:0 & Z:0 Invalid

(3) Summary of Time Signal Manual Output Operation

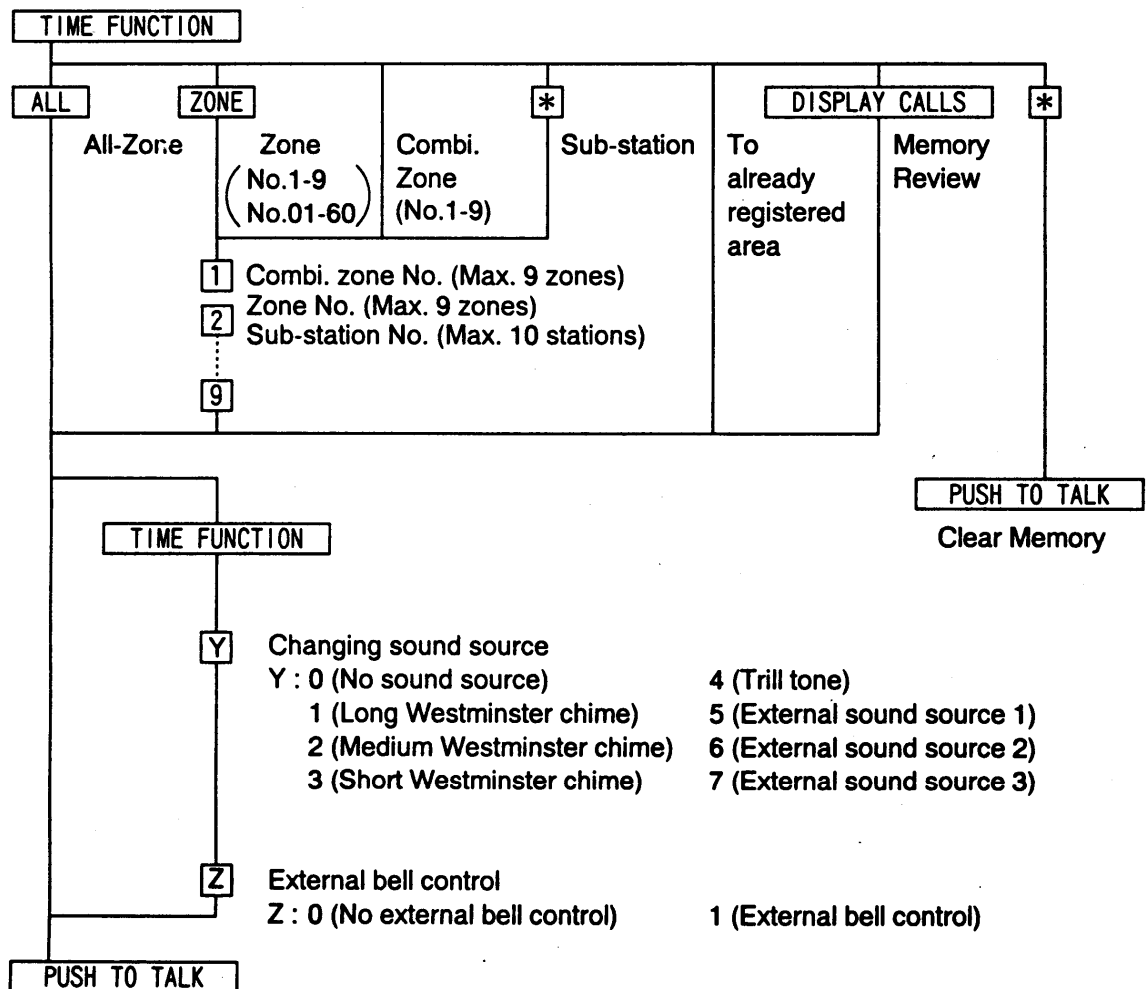

4.4 Program Source Output [Selectable Function]

The IC-100 system can output program source material (such as back-ground music) to selected area.

(1) All-Zone Output

(1.1) To initiate program source output,

- ① Press the **PROGRAM** key.
- ② Press the **ALL** key.
- ③ Press the **PUSH TO TALK** key.

Prog All ^
All-zone program output start.

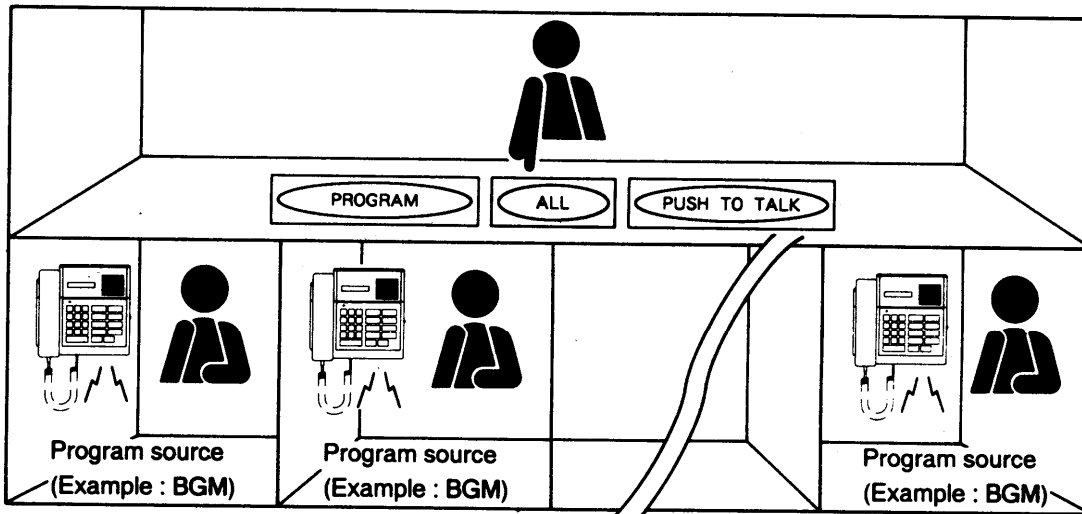

(1.2) To terminate program source output,

- ① Press the **PROGRAM** key.
- ② Press the **C/#** key.

Prog All
Output status display.
Prog All
All-zone program output stop.

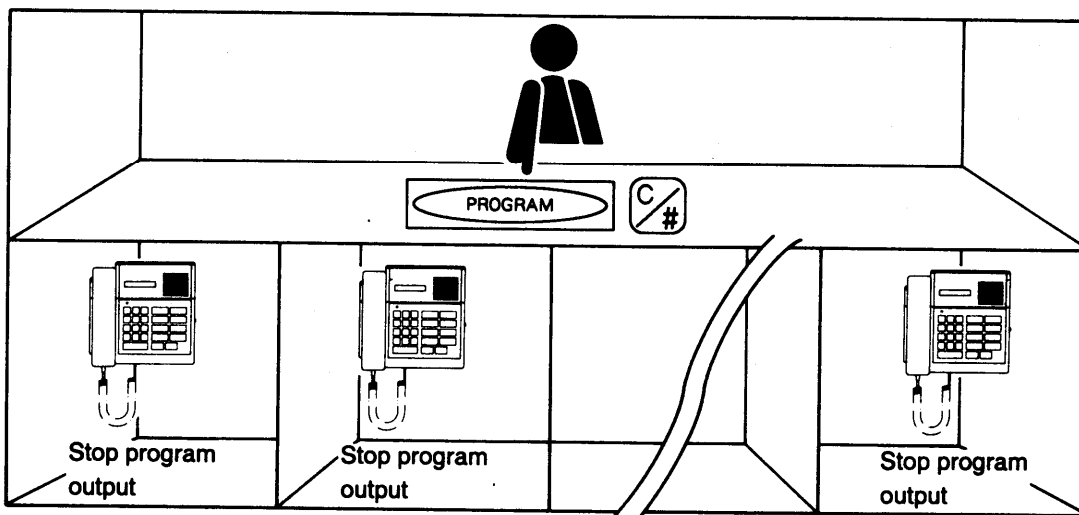

(2) Zone Output

(2.1) To initiate program source output,

- ① Press the **PROGRAM** key.
- ② Press the **ZONE** key.
- ③ Enter Zone No. (i.e. **2** **4** **6**) (Max. 9 zones can be selected simultaneously.)
- ④ Press the **PUSH TO TALK** key.

Prog Z 2 4 6 ^

Start program output to Zones 2, 4, and 6.

(2.2) To terminate program source output,

- ① Press the **PROGRAM** key.
- ② Press the **C/#** key.

Prog Z 2 4 6

Output status display.

Prog Z 2 4 6

Stop program output to Zones 2, 4, and 6.

(3) Combination Zone Output

(3.1) To initiate program source output,

- ① Press the **PROGRAM** key.
- ② Enter Combination Zone No. (i.e. **1** **2** **3**)
- ③ Press the **PUSH TO TALK** key.

Prog C 1 2 3 ^

Start program output to Combination Zones 1, 2, and 3.

(3.2) To terminate program source output,

- ① Press the **PROGRAM** key.
- ② Press the **C/#** key.

Prog C 1 2 3

Output status display.

Prog C 1 2 3

Stop program output to Combination Zones 1, 2, and 3.

(4) Sub-Station Output

(4.1) To initiate program source output,

- ① Press the **PROGRAM** key.
- ② Press the ***** key.
- ③ Enter Sub-station No. (Max. 10: i.e. **2** **0** **0** **1** **2** **0** **0** **2**)
- ④ Press the **PUSH TO TALK** key.

Prog S 2 0 0 2 ^

Start program output to Sub-stations No. 2001 and No. 2002.

(4.2) To terminate program source output,

- ① Press the **PROGRAM** key.
- ② Press the **C/#** key.

Prog S 2 0 0 2

Output status display.

Prog S 2 0 0 2

Stop program output to Sub-Stations No. 2001 and No. 2002.

(5) Confirmation; Re-Output and Output Stop of Registered Programs

Press the **PROGRAM** key.

Prog Z 1 2 3 4

Designated program output areas displayed.

To check for other undisplayed output areas,

press the **DISPLAY CALLS** key.

Prog Z 5 6 7

Next,

press the **PUSH TO TALK** key.

Start program source output to designated areas, or to terminate the program source output,

press **C/#** key.

(6) Program Source Output Indication

In the status of "Program source output" and when the dialed stations are waiting, the indication of "Program ON" is displayed on the control station in a few second interval.

Program ON

(7) Number of Zones

Up to nine broadcast zones (No.1-9) can be established for a single-digit system, and up to 60 zones (No.01-60) can be established for a double-digit system. (Note that zone No.60 is also used for broadcasting time signals to all zones under the "time schedule" and "external time signal trigger" functions, making the virtually available number of broadcast zones 59 for a double-digit system.)

(8) Temporary Station Output Disable

Individual stations can be temporarily designated not to receive control station program source output. This function has three selectable modes;

(8.1) Disable mode

① Total output disable

Totally omits stations from their assigned broadcast zones, with no access to outputs from any control station in the system.

③ Limited output disable (Without automatic reset)

Omits stations from their registered control station output.

Output from other control stations can still be received. (Remains in effect until cancelled by a dialing operation.)

③ Limited output disable (With automatic reset)

Omits stations from their registered control station output.

Output from other control stations can still be received. (Automatically cancelled with voice or signal tone transmission.)

(8.2) Output disable registration

<Registration>

The specified stations can be temporarily omitted from their assigned broadcast zones by the following registration.

*** PROGRAM** **(X)(X)(X)(X)** **(X)(X)(X)(X)** **PUSH TO TALK** **Prog \$ 2000**

Station No. to omit **Station No. to omit**

Max. 4 stations

<Cancellation>

The stations temporarily omitted can be restored to their assigned broadcast zones by the following dial operation.

*** PROGRAM** **PUSH TO TALK** **Prog \$**

[Note] : When "Limited Output Disable (With automatic reset)" mode is set, no dial operation of cancellation is required.

<Confirmation of Registered Stations>

* PROGRAM DISPLAY CALLS

Prog \$ 2000

To check for other undisplayed stations,

DISPLAY CALLS

Prog \$ 2003

(8.3) Output disable indication

When omitting stations from their registered control station output, the "\$" indication is displayed on the control station at the program source output dial operation.

<Example>

- (1) PROGRAM ALL PUSH TO TALK
- (2) PROGRAM ZONE 1 2 3 4 PUSH TO TALK
- (3) PROGRAM 1 2 3 4 PUSH TO TALK

Prog \$	All	A
Prog \$	Z 1234	A
Prog \$	C 1234	A

(9) Summary of Program Source Output Operation

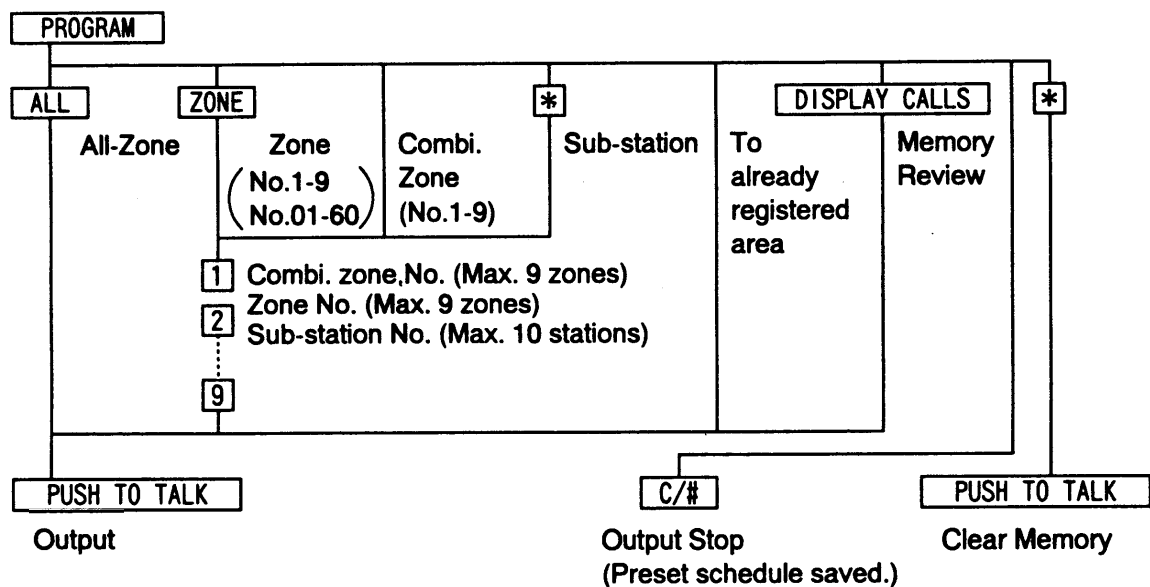

4.5 Computer Connection

Connection of the exchange to a personal computer makes available the following functions. (For details, refer to the separate "IC-100 Control Software" manual.)

- (1) To facilitate system programming, various user-programable functions can be easily registered with a personal computer, and the registered data printed out.
- (2) Records of the most recent exchange operations can be printed out or shown on the computer display.
- (3) Station connections, disconnections, or dialing tests can be performed via the computer keyboard to assist system troubleshooting.
- (4) Messages entered at the computer keyboard can be shown on the connected control station displays or any other external monitors.

SECTION 5. FUNCTION AND OPERATION TABLES

5.1 Dialing Operations

(1) Quick Reference to Dialing Operations

(1.1) Sub-Station

Function		Operation	Remarks
Call Transmission	Call	CALL or lift handset.	
	PBX Station Call *3	CALL or lift handset.	Registered PBX stations only,
	Emergency Call *3	CALL for over 3 seconds	
Privacy	Privacy	Press PRIVACY Press PRIVACY again.	Privacy mode ON Privacy mode OFF

(1.2) Control Station

Function		Operation	Remarks
Calling/Response	Call	X X X X X X X X X	xx :00-99 xxx :000-999 xxxx :0000-9999
	Response to Call	PTT or Lift handset.	
	Selective Response	DISP PTT or DISP Lift handset.	
Conversation Format	Simplex	Press PTT to talk. Release PTT to listen.	
	Voice-Actuated Two-Way Conversation	Sub-station speaker transmission only possible when control station is silent.	(1) With control station (2) With sub-station handset
	Duplex	Lift handset. (Both stations OFF-HOOK)	(1) Control- to sub-station (2) Sub-station to sub-station
		Lift handset. (Either of calling or called Station OFF-HOOK)	Control- to control station
Privacy	Registration	* *	
	Cancellation	* C/#	Operation time Interval : Max. 1 sec.
	Response	Push any key or lift handset.	
Conference	Calling	CONF (X X) X X	Only available to handset stations.
	Last Station Dropout	* (Before the last station lifts handset)	From station that originated conference.

Function		Operation	Remarks	
Conference	Termination	[C/#] or Replace handset	Can only be terminated from a participating control station.	
Station Paging *3	Emergency Paging	[PAGE] [PAGE] [PAGE] [PAGE]	Operation time interval: under 0.5 sec. All-call: All zones (Not all stations)	
	All-Call Paging	[PAGE] [ALL] [PTT] *2	All-call: All zones	
	Zone Paging	[PAGE] [ZONE] [(X)X]...[(X)X] [PTT] *2 Max. 9 zones	X : Zone No.1-9 XX: Zone No.01 -80	
	Combination Zone Paging	[PAGE] [X]...[X] [PTT] *2 Max. 9 zones	X: Combination zone No.1 -9	
	Sub-Station Paging	[PAGE] * [(X)X] [X] [X] ... [(X)X] [X] [X] [PTT] *2 Max. 10 stations	(XX)XX: Sub-station No. (00)00-(99)99	
PA Paging *3		Voice output and zone selection at station station paging key operation	Voice output: 1 zone Selectable external zone outputs: 3 zones	
Microphone All-Call Paging *3		Switch-activated all-call paging from connected external microphone		
Time Signal *3	Manual output	All-Zone	[TIME] [ALL] [(TIME)Y Z] [PTT] *2	(Not all stations)
		Zone	[TIME] [ZONE] [(X)X]...[(X)X] [TIME] [Y Z] [PTT] *2 Max. 9 zones	X : Zone No.1-9 XX: Zone No.01 -60
		Combination Zone	[TIME] [X]...[X] [(TIME)Y Z] [PTT] *2 Max. 9 zones	X: Combination zone No.1 -9
		Sub-Station	[TIME] * [(X)X] [X] [X] ... [(X)X] [X] [X] Max. 10 stations ... [TIME] [Y Z] [PTT] *2	(xx) xx: Sub-station No. (00)00-(99)99
	Sound Source and External Bell Control	<p>To change above program settings, press [TIME] [Y Z] before [PTT].</p> <p>Y: 0 (No sound source) 1 (Long Westminster chime) 2 (Medium Westminster chime) 3 (Short Westminster chime) 4 (Trill tone) 5 (External sound source 1) 6 (External sound source 2) 7 (External sound source 3)</p> <p>Z: 0 (No external bell control) 1 (External bell control)</p> <p>Y: 0 & Z:0 Invalid</p>		
	Schedule Selection *1		x :0 (output stop) 1-8 (A-H)	

Function			Operation	Remarks
Program source output *3	output start	All-Zone	PROG ALL PTT *2	(Not all stations)
		Zone	PROG ZONE (X) X ... (X) X PTT *2 Max. 9 zones	X : Zone No.1 -9 XX: Zone No.01 -80
		Combi. Zone	PROG (X) ... (X) PTT *2 Max. 9 zones	X: Combination zone No.1 -9
		Sub-Station	PROG * ((X) X) X X ... PTT *2 Max. 10 stations	(XX) XX: Sub-station No. (00)00-(99)99
	output stop		PROG C/#	
Individual Output Stop		C/#		
Temporary Station output Disable *3	Registration	* PAGE ((X) X) X X ... PTT * TIME Station No. to omit * PROG (Max. 4 stations)		
	Cancellation	* PAGE PTT * TIME * PROG		
	Confirmation of Registered Stations	* PAGE DISP DISP ... * TIME * PROG		
PBX Station Dial Operation*3	Call	[K]...[K] (X) X X Extension access No.		
	Voice-Actuated Two-Way Conversation	Sub-station speaker transmission only possible when PBX station is silent.	(1) With control station (2) With sub-station handset	
	Full-Duplex Conversation		(1) With control station (2) With sub-station handset	
	All-Call Paging	[K]...[K] * 8 (0) 0 * Extension access No.		
	Zone Paging	[K]...[K] * 8 ((X) X) ... ((X) X) * Extension access No. Max. 9 zones	X,1-9,XX:01-60	
	Combination Zone Paging	[K]...[K] * 9 (X) ... (X) * Extension access No. Max. 9 zones	X: 1-9 (Combination zone)	
	Termination	Press # key before replacing handset.		
PBX Station Access *3	Control Station Call	① TEL X X ... X or ② TEL 1 X X ... X TEL 2 X X ... X	XX...X: PBX station No. Access Nos.1 and 2 distinguish C/O line from PBX.	

Function		Operation	Remarks
PBX Station Access *3	PBX Station Call Transfer	PTT (X X) X X Call hold C/# or Replace handset.	(XX)XX: Station No. to be transferred to Only possible to handset station.
	Call Re-Connection	PTT (X X) X X Call hold * or Replace the third party's handset.	Not transferable to C/O fine and PBX station.
C/O Line *3	Calling	① TEL X X or ② TEL 1 X X TEL 2 X X	x)(: Telephone No. Access No.1 and 2 distinguish C/O line from PBX.
	Receiving	Lift handset.	
	Call Transfer	PTT (X X) X X Call hold C/# or Replace handset.	(XX)XX: Station No. to be transferred to Only possible to handset station.
	Call Re-Connection	PTT (X X) X X Call hold * or Replace the third party's handset.	Not transferable to C/O line and PBX station.
Internal Line	Call Transfer	(X X) X X Call hold C/# or Replace handset.	(XX)XX : Station No. to be transferred to Only possible to handset station.
	Call Re-Connection	PTT (X X) X X Call hold * or Replace the third party's handset.	Not transferable to C/O line and PBX station.
Call Forwarding	Call Forwarding Registration	* 6 (X X) X X (Conf. Tone)	(XX)XX : Control station No. to be transferred to , .
	Auto-Call C/O Transfer Registration *3	* 6 TEL Sub-station calls automatically transferred to pre-programmed C/O line.	Control station calls received without call forwarding.
	Cancellation	* 6 (X X) X X (Conf. Tone)	(XX)XX : Originally assigned station No.
Speed Dialing *3	Single-Digit Dialing	X	X : Designated No.
	2-Digit Dialing	X Y	Y: User programabfe No. (0-9)
	Registration	* 7 X (Y) Z Z PTT (Conf. Tone)	Z: No. to be registered (Max. 32 digits)
Redialing		REDIAL	Max. 24 digits can be redialed. (Except DISP , PRIO , * , C/# keys)
Duress Alarm *3	Operation	Take handset off for over 6 seconds.	
	Cancellation	C/# and Replace handset.	
Time Setting and Adjustment *1	Time Setting	* 4 H H M M PTT (Conf.Tone)	HH :00-23 (Hour) MM :00-59 (Minute)
	12-/24-Hour Mode Switching	* 5 PTT (Conf.Tone)	Toggles between 12-hour and 24-hour modes.

Function		Operation	Remarks
Time Setting and Adjustment *1	Second Synchronization	*4 PTT PTT (Reset to "00") C/# (Initial status display)	1-30 sec : Zero reset to same minute. 31-59 sec: Zero reset to next minute.
Priority	Registration	PRIO (X X) X X PTT (Conf.Tone)	X: Sub-station No. Only possible at control station assigned to "Priority" sub-station. Toggles between "priority" and originally designated priority.
	Confirmation/Call	PRIO DISP (Registration confirmation) PTT or Lift handset (Call).	
Call Display Memory Clear		DISP ALL ALL ALL ALL or *000	
Scan Monitor	Monitoring Start	*2 (X X) (X X) (Y Y) (Y Y) PTT First station No. Last station No.	
	Stop/Restart	PTT (Scanning stop) PTT (Scanning restart)	
	Single Station FORWARD	ALL	
	Single Station BACK	ZONE	
	Scan Interval Registration	*2 TIME X	X:1-9 (sec.) (Preset for 1 sec.)

[Note] : (1) *1 : Only Possible with the "Unrestricted" control or PBX station.

*2 : [PUSH TO TALK] or Lift handset.

(2) Some keys and words are abbreviated in this reference list.

PTT	:	PUSH TO TALK	key	TIME	:	TIME FUNCTION	key
DISP	:	DISPLAY CALLS	key	PRIO	:	PRIORITY	key
CONF	:	CONFERENCE	key	TEL	:	TELEPHONE	key
PROG	:	PROGRAM	key	Conf. Tone : Confirmation Tone			

(3) *3: Selectable function refers to the functions that can be selected by system programming.

(4) For details of dial-free functions (conversation time-out, calling time-out, Alert tones during conversation, etc.), refer to the IC-100 Installation Manual, Chapter 5-1., "Programmable Functions".

(2) Transmission Area Registration

[PAGING] [TIME SIGNAL MANUAL OUTPUT] [PROGRAM SOURCE OUTPUT]

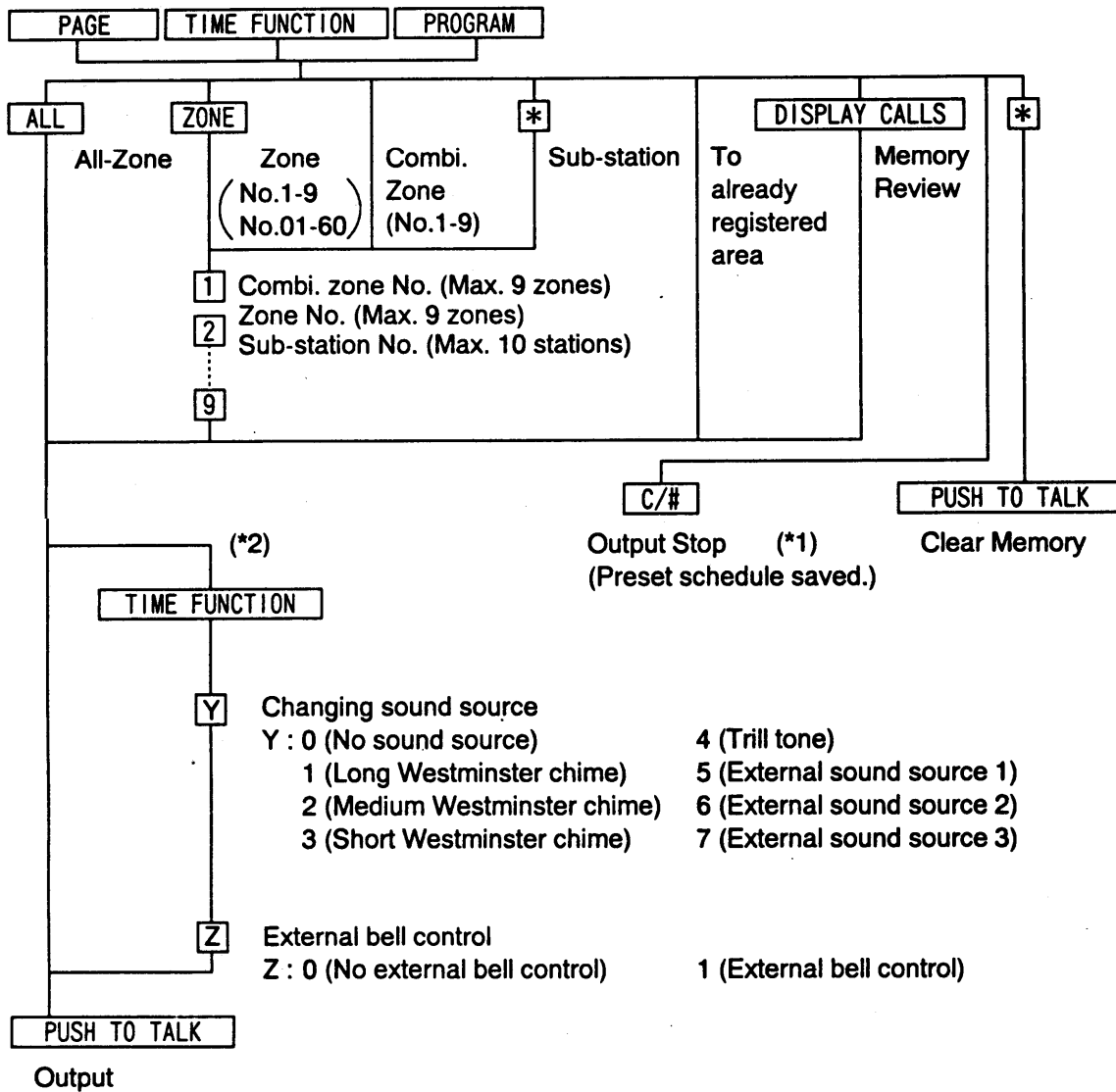

[Note] : (1) Only available for "Program Source Output" function.

(2) Only available for "Time Signal" function.

5.2 Priority Order

The IC-100 system has two separate priority orders: (1) Broadcast/conversation priority and (2) Call display priority.

(1) Broadcast/Conversation Priority

- (1.2) The interrupted broadcast or conversation is resumed upon completion of higher priority function override.
- (1.3) Broadcasts or conversations overridden by Emergency All-Call Paging are not resumed.
- (1.4) Conversation cannot be overridden by regular or emergency calls from a sub-station.
- (1.5) Handsfree call reception from a control station is impossible when a sub-station is calling. Waiting calls are received in the handsfree mode when the current sub-station conversation is terminated.

<Broadcast and Conversation Priority List>

- (1) Current C/O line and PBX extension conversation *4
 - (2) Emergency all-call paging *1
 - (3) Emergency call
 - (4) Duress alarm
 - (5) Time signal *2
 - (6) All-call paging (including PBX station all-call paging)/External microphone all-call paging *2 *3
 - (7) Zone/Combination zone/Sub-station paging *2 *3
 - (8) Conversation (including unanswered calls)
 - (9) Program output
- *1 Overridden lower priority functions not restored, even after function completion.
*2 Overridden lower priority functions restored after function completion.
*3 Paging made when higher priority functions are operating is put in waiting mode.
*4 The current outside C/O line and PBX extension conversation is not interrupted by any function. Emergency all-call paging and time signal are broadcast to the zones except the control station connected to the C/O line and PBX extension.

(2) Call Display Priority

- (2.1) The numbers of all stations calling an unused station are displayed in priority order, with those having the same priority shown on a first-come-first-served basis.
- (2.2) With subsequent depressions of [DI SPLAY CALLS] key, lower priority waiting stations can be displayed.
- (2.3) Current conversations or received broadcasts are not overridden by incoming station calls, which are displayed in priority order. To answer, the conversation must first be terminated. However, calls received while being broadcast can be answered by merely pressing the [PUSH TO TALK] key or lifting the handset.

<Call Display Priority List>

- (1) Emergency all-call paging
- (2) Emergency call
- (3) Duress alarm
- (4) Outside C/O line call
- (5) Priority sub-station call
- (6) Alarm-priority sub-station call
- (7) Normal priority sub-station call
- (8) Staff priority sub-station call
- (9) Control station call
- (10) PBX extension call

Emerg. Page
1234 Emerg.
5678 Duress
C/O Line
1234P
2345A
3456N
4567S
5678
PBX Line

5.3 Signal Tones

Signal Tone		Signal Source and Output Timing
① Dial Confirmation Tone	Brief Single Tone	
② Error Tone	Brief Single Tone	
③ Busy Tone	Intermittent Single Tone	
④ Sub-Station Call Tone	Intermittent Single Tone	
⑤ Sub-Station Call Tone (Priority and Alarm)	Intermittent Single Tone	
⑥ Emergency Call Tone	Intermittent Trill Tone	
⑦ Confirmation Tone	Intermittent Single Tone	
⑧ Call Forwarding Tone	Intermittent Single Tone	
⑨ Sub-Station Privacy Tone	Intermittent Single Tone	
⑩ Control Station Privacy Tone	Intermittent Trill Tone	
⑪ Sub-Station Conversation Start Tone	Brief Single Tone	
⑫ Control Station Conversation Start Tone	Brief Trill Tone	
⑬ Emergency All-Call Paging Tone	Intermittent Trill Tone	
⑭ Paging Pre-Announcement Tone (All-Call/Zone/Combi. Zone)	(1) 4-note Chime	
	(2) Brief Single Tone	
⑮ C/O Line and PBX Extension Hold Tone	Intermittent Single Tone	
⑯ C/O Line Call Tone	Intermittent Trill Tone	
⑰ Duress Alarm Tone	Intermittent Trill Tone	
⑱ Time Signals	(1) Westminster Chime	
	(2) Trill Tone	
	(3) External Bell	

Note: (1) Single Tone
 (2) Trill Tone
 (3) Intermittent Single Tone
 (4) Intermittent Trill Tone

5.4 Operation Display Examples

(1) Reception

- | | | |
|---|---------------|--|
| ① | 1234N | No.1234 calling. |
| ② | 1234N M | Other stations calling. |
| ③ | 1234N | Connect to No.1234. |
| ④ | 1234N : 2345N | No.2345 calling during conversation with No.1 234. |
| ⑤ | 1234N: 2345NM | Other stations besides No.2345 calling during conversation with No.1234. |
| ⑥ | 3456 Emerg. | (1) Emergency call from No.3456. .
(2) Connect to No.3456. |
| ⑦ | 3456 Emerg. E | (3) Emergency call from No.3456 during conversation with No.1234.
(1) Emergency calls from No.3456 and other sub-stations.
(2) Another emergency call made during conversation with No.3456.
(3) Emergency call from No.3456 and duress alarm from other control station. |
| ⑧ | 3456N: 4567E | Emergency call from No.4567 during conversation with No.3456. (*1) |
| ⑨ | 3456N: 5678D | Duress alarm from No.5678 during conversation with No.3456.(*1) |
| ⑩ | 3456N: 4567EE | Emergency call from No.4567 and other station during conversation with No.3456. (*1) |
| ⑪ | C/O Line | (1) Call from C/O line.
(2) Conversation with C/O line. |
| ⑫ | C/O Line M | (3) Call from C/O line during conversation with internal line.
(1) Calls from both C/O and internal lines.
(2) Call from internal line during conversation with C/O line. |
| ⑬ | PBX Line | (1) Call from PBX extension.
(2) Conversation with PBX extension. |
| ⑭ | PBX Line M | (3) Call from PBX extension during conversation with internal line.
(1) Calls from both PBX extension and internal lines.
(2) Call from internal line during conversation with PBX extension. |
| ⑮ | 5678 Duress | Duress alarm from No.5678 control station. |
| ⑯ | 5678DuressE | Duress alarm from No.5678 and other control station. |
| ⑰ | Emerg.Page | (1) Emergency all-call paging during emergency call or duress alarm.
(Emergency call or duress alarm is displayed upon emergency all-call paging completion.)
(2) Emergency call or duress alarm entry during emergency all-call paging.
(Neither emergency calls nor duress alarms can be accepted during emergency all-call paging. In such a case, restart operation.) |

(*1) Initial display after confirming undisplayed waiting stations with the [DISPLAY CALLS] key.

[Note] : (1) The suffix "M" indicates other waiting stations, which can be displayed with subsequent depressions of the [DISPLAY CALLS] key.

(2) The suffix "E" indicates waiting emergency calls or duress alarm, which can be displayed with subsequent depressions of the [DISPLAY CALLS] key.

(2) Transmission

①	E m e r g . P a g e	Emergency all-call paging
②	P a g e A l l	All-call paging
③	P a g e Z 2 4 6	Zone paging
④	P a g e C 1 2 3	Combination zone paging
⑤	P a g e S 1 2 3 4	Sub-station paging
⑥	T i m e Z 2 4 6	Manually activated time signal
⑦	P r o g Z 2 4 6	Program output
⑧	P a g e \$ S 1 2 3 4	Sub-station paging with output disable indication
⑨	T i m e \$ Z 2 4 6	Manually activated time signal with output disable indication
⑩	P r o g \$ Z 2 4 6	Program output with output disable indication
⑪	T e l : 0 7 9 7 7 1 2	Outside C/O line calling
⑫	T e l : 3 4 0 1	PBX station calling
⑬	2 3 4 5 N	Internal calling
⑭	C : 1 2 3 4 : 2 3 4 5	Conference calling
⑮	1 2 3 4 → 2 3 4 5	Call forwarding from No.1234 to No.2345
⑯	O f f - H o o k	Duress alarm

(3) Miscellaneous

“Priority” station registration
Call forwarding registration
Auto-call C/O transfer
Program source output indication

5.5 Note on Operation

(1) Emergency Call

- (1.1) When three or more sub-stations are simultaneously operated while paging is being established in the system, the regular sub-station calls can be converted into emergency calls.
- (1.2) Answering an incoming emergency call to a control station by pressing its [PUSH TO TALK] key or lifting its handset while paging is being established in the system can terminate current conversations and paging, including those at other stations.

(2) Paging

No paging call can be made from any control station when three or more sub-station calls are simultaneously operated.

(3) Number of Storable Waiting Stations

A maximum of 120 waiting station numbers can be stored and displayed per control station. Incoming calls received in excess of this capacity are all ignored, including an Emergency call.

(4) Call Display Memory Clear

Pressing [DISPLAY CALLS] [ALL] [ALL] [ALL] [ALL] keys will delete and disconnect all stored waiting stations.

[Note] : This function cannot be operated while the control station is receiving an Emergency call.

5.6 Restrictions by Tie-Line Systems

Note the following restrictions a tie-line system can cause to the C/O line functions when installing the control stations.

(1) Call Forwarding

- (1.1) All incoming regular station calls can be rerouted to any control stations registered for the Call Forwarding function.
- (1.2) If the registered control station is connected to the other exchange, incoming C/O line calls are connected to the original station without being rerouted.

(2) Access to C/O Line Calls

Only the station whose exchange is connected to the C/O line can make or receive a C/O line call.

(3) C/O Line Conversation

C/O line conversations are not overridden by the Emergency all-call paging. However, they can be interrupted (very seldom, though) so as to allow the Emergency all-call paging to go through when a great number of calls are being "simultaneously made in an entire tie-line system. (The interruption occurs only when the total number of C/O lines of the tie-line system is equal to or greater than that of tie-line links.)



TOA Corporation
KOBE, JAPAN

E3.0

133-06-180-6B