

DA-250F/250FH

Multi-Channel Digital Power Amplifiers



DESCRIPTION

The DA-250F and DA-250FH power amplifiers utilize advanced digital technology to provide multi-channel high power outputs. Featuring high efficiency amplifier topology, the low impedance version DA-250F and high impedance version DA-250FH are ideal for various installed sound applications. The lightweight construction and compact dimensions of the DA Series allows for easy placement in virtually any venue, as well as for use in stacked configurations as required. Each amplifier is designed for ultra-reliable long-term operation with multiple independent power supplies that ensure uninterrupted operation even if a channel fails. Redundant protection circuitry monitors amplifier status and protects the amplifier and system in case of problems.

FEATURES

- High efficiency**
 Extremely high amplification efficiency of 80-90%, resulting in reduction in power consumption by more than 60% compared with Class-AB amplifiers.
- Highly durable**
 Stands up to extended hours of operation. The DA amplifier has undergone a large number of rigorous tests to prove its durability. In addition, TOA has been conducting a “non-stop driving test” of the DA Series.
- High reliability**
 The DA amplifier has a comprehensive protection circuitry for protection against excessive current flow due to overload, short circuit, unusual DC voltage output, and power amplifier heat sink temperature rise (over 110°C/167°F), temperature rise inside the unit (over 80°C/176°F).
- Amplifier with lightweight design**
 Installation has become much easier thanks to the lightweight design.
- Compact design**
 The DA-250 Series is 1-unit size, and they can be efficiently mounted on a rack, so they require only a small installation space. Because the amplifiers do not generate much heat, 5 units can be stacked together in a rack.
- Independent power supply**
 Each of the channels has its own power supply. If the power supply of Channel 1 should fail, this won't affect the operation of Channel 2 – 4. It is also possible to use the either channel as a spare amplifier.

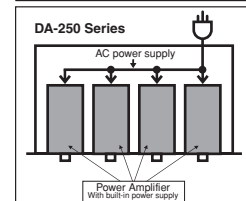
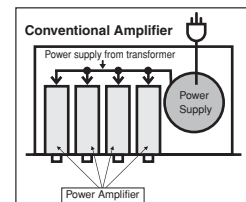
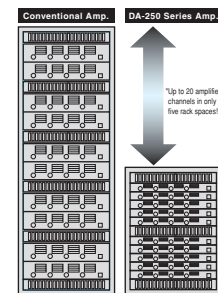
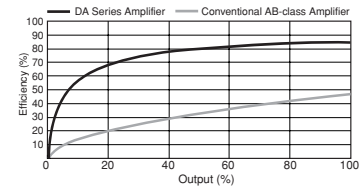

CU Version

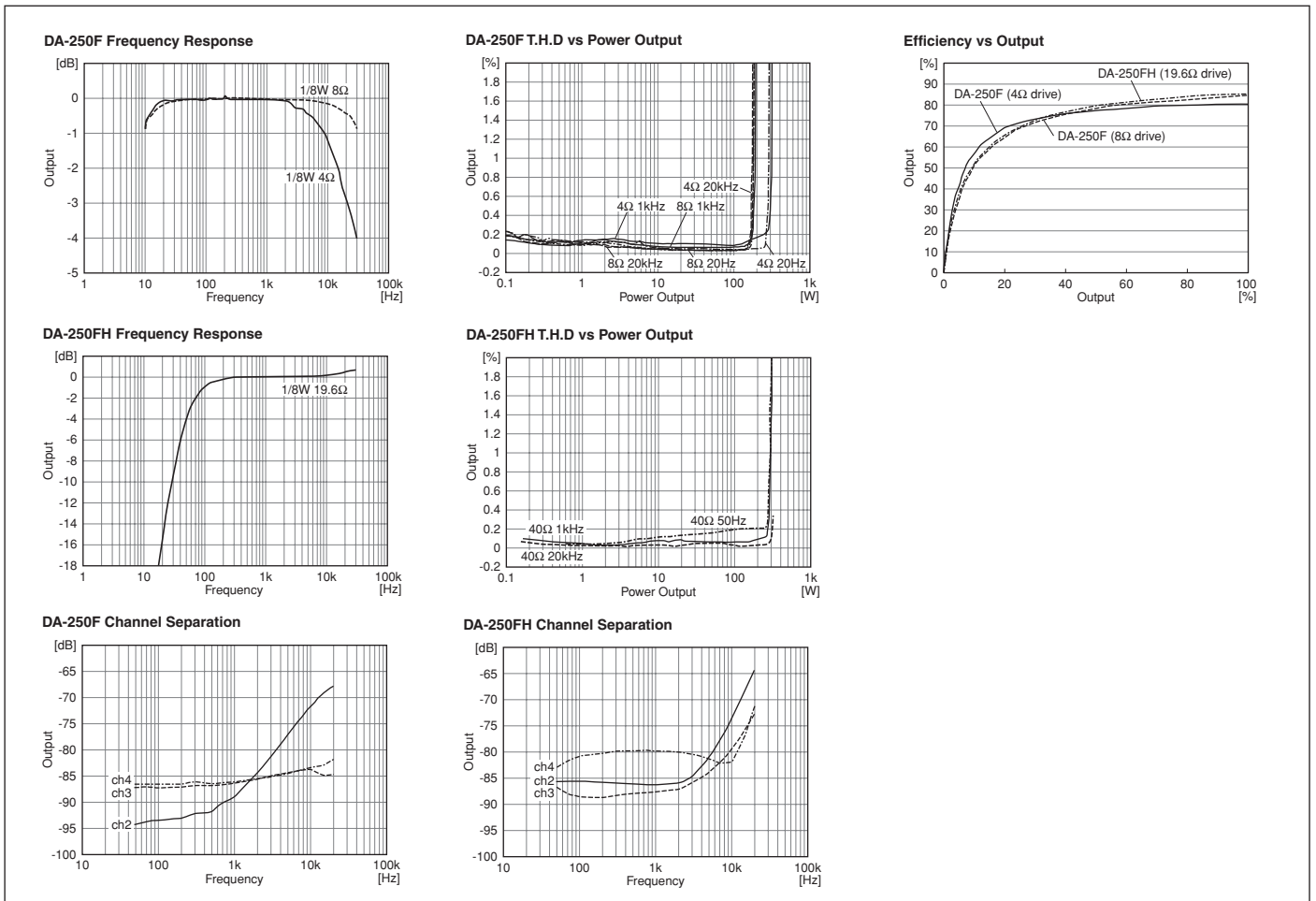

APPEARANCE AND DIMENSIONAL DIAGRAM

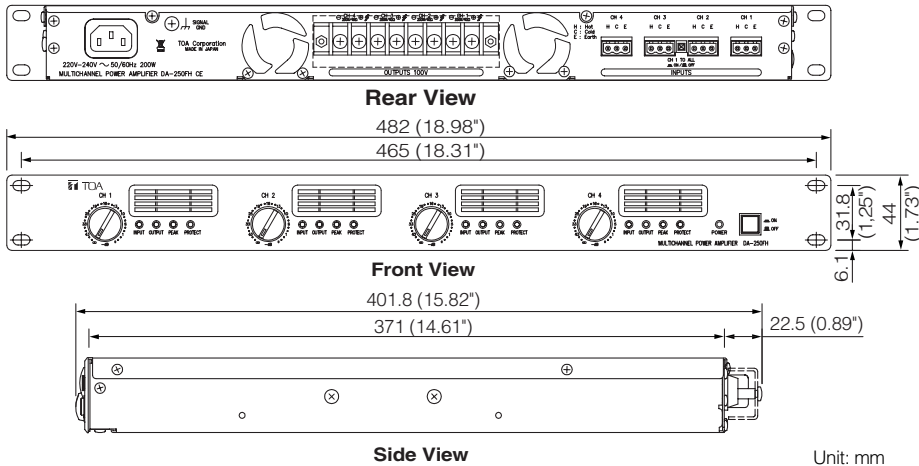

THERMAL LOSS TABLE

Mode	Model No.	Load	Btu/hr	kcal/hr	Efficiency(%)
Idle	DA-250FH	70V × 4ch	199.7	50.3	—
	DA-250F	4 Ω × 4ch	193.6	48.8	—
1/8 Power (pink noise)	DA-250FH	70V × 4ch	446.2	112.4	50.8
	DA-250F	8 Ω × 4ch	317.9	80.1	49.2
		4 Ω × 4ch	385.5	97.1	56.2
	1/3Power (pink noise)	DA-250FH	70V × 4ch	850.1	214.1
DA-250F		8 Ω × 4ch	417.9	105.3	66.2
		4 Ω × 4ch	720.1	181.4	64.7
Full Power (sin)		DA-250FH	70V × 4ch	688.1	173.4
	DA-250F	8 Ω × 4ch	512.7	129.2	84.4
		4 Ω × 4ch	1071.0	269.9	80.4

*Typical data

ARCHITECTURAL AND ENGINEERING SPECIFICATIONS

DA-250F (4 × 250W @ 4 ohms) SPECIFICATIONS

The multi-channel power amplifier shall use digital class-D circuit topology and shall be configurable to allow two, three or four channel operation. Power output in four-channel mode with all channels driven shall be: 250 watts per channel into 4 ohms and 170 watts per channel into 8 ohms. Each pair of channels shall be independently bridgeable to produce 500 watts into 8 ohms. Total harmonic distortion (THD) shall be less than 0.1% at 1 kHz and less than 0.3% from 20 to 20,000 Hz. Frequency response shall be 20 to 20,000 Hz (+/- 1 dB). Hum and noise shall be 100 dB below rated output (A weighted). Crosstalk shall be better than 70 dB (A weighted). Input sensitivity shall be +4 or -10 dBv (jumper selectable) for rated output, where 0 dBv = 0.775 volts RMS. Input impedance shall be 10k ohms for each side of an electronically balanced input circuit. Rear-panel switches shall allow selection of bridged operation for each pair of channels (1-2 and 3-4) independent of the status of the other pair of channels. The amplifier shall operate in 4-channel mode when both switches are deselected, in 3-channel mode when either switch is selected, and 2-channel mode when both switches are selected. A rear-panel input mode switch shall allow the selection of "channel 1 to all" mode, whereby the signal feeding the channel 1 input terminals is simultaneously fed to all other channels. Rear panel input connector shall be a 3-pin removable terminal block for each channel. Rear panel output connector shall be a heavy-gauge M4 screw-terminal barrier strip suitable for spade lugs or up to #12 AWG bare wire. The front-panel attenuators shall be recessed to prevent accidental level changes and may be removed and replaced by included security covers once levels have been properly set. The front panel shall have four sets of four LED indicators to indicate the following conditions for each channel: signal presence at input (greater than -20 dBv), signal presence at output (greater than 1 watt at 8 ohms), peak clipping, and protection circuit activation. The front panel shall also have removable air filters that may be cleaned and reinstalled without removing the amplifier from a rack. Built-in protection circuitry shall monitor Voltage and current levels to minimize potential damage from overloads, and disable output during shorts, DC offset, excessive operating temperature at power amp heat sink over 167°F (110°C) or excessive temperature inside the unit over 176°F (80°C) via a relay for each channel. The relay shall also delay amplifier connection to the load during turn-on for about 2 seconds, so as to prevent any concurrence of noise at turn-on. Power consumption shall be no more than 200 watts when all channels are driven with continuous pink noise at 1/8 full power into 4 ohms (UL/CSA standard), and no more than 1,300 watts when all channels are driven with continuous pink noise at full rated power into 4 ohms. The amplifier shall use only one standard rack-space or 1.75" (44.5 mm) and its dimensions shall be 19" (482 mm) W x 15.8" (401.8 mm) D x 1.7" (44 mm) H. Front panel finish shall be black anodized aluminum and case finish shall be sheet steel. Weight shall be 14.6 lbs. (6.6 kg). The amplifier shall be TOA model DA-250F.

DA-250FH (4 × 250W @ 70V) SPECIFICATIONS

The multi-channel power amplifier shall use digital class-D circuit topology and shall be configurable to allow two, three or four channel operation. Power output in four-channel mode with all channels driven shall be: 250 watts per channel into 19.6 ohms (70.7 volts). Each pair of channels shall be independently bridgeable to produce 500 watts into 39.2 ohms (140 volts). Total harmonic distortion (THD) shall be less than 0.1% at 1 kHz and less than 0.3% from 20 to 20,000 Hz when High-pass filter is off. Frequency response shall be 20 to 20,000 Hz (+/- 1 dB) when High-pass filter is off, 50 to 20,000 Hz (-3 dB, +1 dB) when High-pass filter is on. Hum and noise shall be 100 dB below rated output (A weighted). Crosstalk shall be better than 70 dB (A weighted). Input sensitivity shall be +4 or -10 dBv (jumper selectable) for rated output, where 0 dBv = 0.775 volts RMS. Input impedance shall be 10k ohms for each side of an electronically balanced input circuit. Rear-panel switches shall allow selection of bridged operation for each pair of channels (1-2 and 3-4) independent of the status of the other pair of channels. The amplifier shall operate in 4-channel mode when both switches are deselected, in 3-channel mode when either switch is selected, and 2-channel mode when both switches are selected. A rear-panel input mode switch shall allow the selection of "channel 1 to all" mode, whereby the signal feeding the channel 1 input terminals is simultaneously fed to all other channels. Rear panel input connector shall be a 3-pin removable terminal block for each channel. Rear panel output connector shall be a heavy-gauge M4 screw-terminal barrier strip suitable for spade lugs or up to #12 AWG bare wire. The front-panel attenuators shall be recessed to prevent accidental level changes and may be removed and replaced by included security covers once levels have been properly set. An internal jumper for each channel shall allow independent on/off selection of a 50 Hz high pass filter for protection against excessive low frequency loading and saturation of speaker transformers. The front panel shall have four sets of four LED indicators to indicate the following conditions for each channel: signal presence at input (greater than -20 dBv), signal presence at output (greater than 1 watt at 8 ohms), peak clipping, and protection circuit activation. The front panel shall also have removable air filters that may be cleaned and reinstalled without removing the amplifier from a rack. Built-in protection circuitry shall monitor Voltage and current levels to minimize potential damage from overloads, and disable output during shorts, DC offset, excessive operating temperature at power amp heat sink over 167°F (110°C) via a relay for each channel or excessive temperatures inside the unit over 176°F (80°C). The relay shall also delay amplifier connection to the load during turn-on for about 2 seconds, so as to prevent any concurrence of noise at turn-on. Power consumption shall be no more than 200 watts when all channels are driven with continuous pink noise at 1/8 full power into 19.6 ohms (UL/CSA standard), and no more than 1,200 watts when all channels are driven with continuous pink noise at full rated power into 19.6 ohms. The amplifier shall use only one standard rack-space or 1.75" (44.5 mm) and its dimensions shall be 19" (482 mm) W x 15.8" (401.8 mm) D x 1.7" (44 mm) H. Front panel finish shall be black anodized aluminum and case finish shall be sheet steel. Weight shall be 14.6 lbs. (6.6 kg). The amplifier shall be TOA model DA-250FH. The optional 1:1 line isolation transformer shall be TOA model MT-251H

OPTION

MT-251H

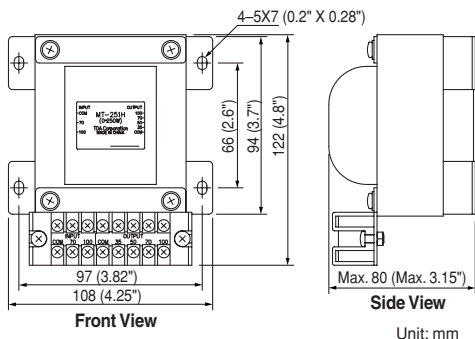

Matching Transformer

Designed for use with the DA-250FH Multi-Channel Amplifier (option), the MT-251H electrically isolates the high-impedance speaker lines from the amplifier.

- **Capacity:** 0W – 250W
- **Primary Side:** 100V line, 70V line
- **Secondary Side:** 100V line, 70V line, 50V line, 35V line
- **Frequency Response:** 30 – 18,000Hz (+0dB, -3dB)
- **Connection Terminal:** M3 screw terminal, distance between barriers: 6.6mm (0.26")
- **Dimensions:** 108 (W) x 80 (H) x 122 (D)mm (4.25" x 3.15" x 4.80")
- **Weight:** 2.4kg (5.29 lbs)

SPECIFICATIONS

Model	DA-250F	DA-250FH
Power Source	120V AC , 50/60Hz	
Number of Channels	4	
Total Output All Channel Driven	1,000W (1kHz, 4Ω) 680W (1kHz, 8Ω)	1,000W (1kHz, 19.6Ω: 70V line)
Output Voltage per Channel	31.6V (1kHz, 4Ω) 36.9V (1kHz, 8Ω)	70V (1kHz, 19.6Ω: 70V line)
Output Current per Channel	7.9A (1kHz, 4Ω) 4.6A (1kHz, 8Ω)	3.6A (1kHz, 19.6Ω: 70V line)
Power Output 8 ohms per channel 4 ohms per channel 16 ohms bridged 8 ohms bridged Hi-Z: 70V per channel Hi-Z: 140V bridged, per channel	170W 250W 340W 500W — —	— — — — 250W 500W
Power Consumption* Idle power consumption	56W, 1.0A	58W, 1.0A
Rated power consumption 8 ohms 1kHz 4 ohms 70 Volts	850W, 11.7A 1,300W, 16.9A —	— — 1,200W, 15.9A
1/8 Power*1 8 ohms Pink noise 4 ohms 70 Volts	183W, 3.0A 257W, 4.2A —	— — 265W, 4.1A
1/3 Power*2 8 ohms 4 ohms 70 Volts	362W, 5.4A 597W, 8.6A —	— — 609W, 8.5A
1/8 Power 8 ohms 1kHz 4 ohms 70 Volts	152W, 2.5A 219W, 3.5A —	— — 224W, 3.6A
1/3 Power 8 ohms 4 ohms 70 Volts	314W, 4.7A 507W, 7.3A —	— — 499W, 7.2A
Frequency Response	20Hz – 20kHz (±1dB)	HPF OFF: 20Hz – 20kHz (±1dB) HPF ON: 50Hz – 20kHz (-3/+1dB)
THD	0.1 % (1kHz) 0.3 % (20Hz – 20kHz)	HPF ON: 0.1 % (1kHz), 0.3% (100Hz – 20kHz) HPF OFF: 0.1 % (1kHz), 0.3% (20Hz – 20kHz)
S/N Ratio (A weighted)	100dB	
Crosstalk at 10kHz (A weighted)	70dB	
DC Offset*	±5mV	
Voltage Gain*	29.5dB	35.1dB
Damping Factor*	100 (1k Hz, 8Ω)	220(1k Hz, 19.6Ω: 70V line)
Inputs Input impedance Input sensitivity Input clipping	10kΩ (unbalanced), 20kΩ (balanced) +4dB (1.23V) 14V (25.1dBu)	
Front Panel Gain controls Indicators per channel: Input Output Peak Protect Power-On	30 position detent Green LED Yellow LED Red LED Red LED Blue LED	
Rear Panel Input connectors Speaker output	Detachable Euro style terminal block (electrically balanced) Screw terminal (M4). Accept AWG14-22	
Protection Circuit Amplifier section Power supply section	DC output, overheat protection, load shorting, overload current, maximum output Overheat protection, AC rush current	
Operating Temperature	-10°C to +40°C (14°F to 140°F)	
Operating Humidity	Under 90% RH (no condensation)	
Dimensions	482 (W) × 44 (H) × 401.8 (D) mm (18.98" × 1.73" × 15.82") (EIA Standard 19-inch rack mount width)	
Weight	6.6kg (14.6 lbs)	
Finish	Panel: Aluminum, alumite process, black Case: Plated steel sheet	
Accessories	Euro style terminal block connector (3-pin) × 4, Tamper-proof cap × 4	
Option	—	Matching transformer: MT-251H

0dB=0.775Vrms

* Typical data

*1/8 power with pink noise represents typical program with occasional clipping.

*2/3 power with pink noise represents severe program with heavy clipping.



TOA Canada
www.toacanada.com