

DIGITAL AUDIO PROCESSOR

DP-K1



DESCRIPTION

The TOA DP-K1 is an easy-to-operate digital audio processor equipped with gain, equalizer, crossover, compressor, noise gate, matrix, delay and Automatic Resonance Control functions. The advanced new Automatic Resonance Control (ARC) function enables the DP-K1 to automatically measure and process the acoustic response characteristics of complex environments and provide compensatory parameter settings to improve speech intelligibility and sound quality. This latest addition to the TOA line of digital audio processors makes it easy to bring optimal sound enhancement even to acoustically challenging venues such as houses of worship, sports facilities, convention centers, airports, and many other venues. The DP-K1's modular design supports up to eight mic/line inputs and eight line outputs with flexible contact-closure remote control.

FEATURES

- Advanced new Automatic Resonance Control (ARC) function improves system intelligibility.
 - The ARC function automatically measures frequency characteristics of the broadcast area and finds resonant frequencies.
 - Automatically creates a filter curve that curbs unwanted resonant frequencies for the measured room response.
 - Improves speech intelligibility and sound quality in facilities with challenging acoustic environments.
 - Unlike earlier, time-consuming manual adjustment methods that required electro-acoustic engineers, operation is quick and easy.
 - Fully comprehensive operating capability means no dedicated device is required.

- Digital audio processor has built-in rack-mount brackets (3 RU, EIA standard 19 inch rack mount width) for commercial sound applications such as houses of worship, sports facilities, convention centers, airports, and many others.
- Cost-effective modular design — up to 8 inputs and 8 outputs
 - Users can choose from among a variety of optional modules.
- Up to 16 different user-created combination configurations are possible.
- Built-in gain, equalizer, crossover, compressor, noise gate, matrix and delay audio processor functions
- Eight bus matrix allows flexible input-to-output signal routing for zoning or room combining.
- PC software for offsite programming and settings
- Network interface for remote programming and maintenance
- Network ports are available on both front and rear panels.
- 8 internal memories for storage and recall of different signal routing and parameter configurations.
- Preset knob-lock function prevents accidental errors during operation.
- Input and output channel indicators
- Cooling fan ensures continuous, reliable operation.



DP-K1

DIGITAL AUDIO PROCESSOR



APPEARANCE AND DIMENSIONAL DIAGRAM

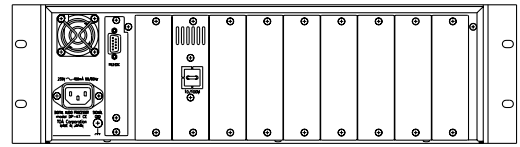

Rear View

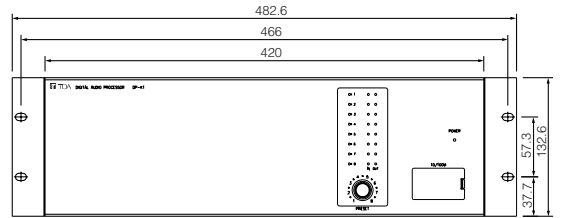

Front View

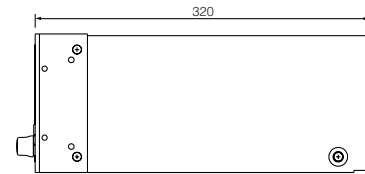

Side View

Modules

Modular design allows you to configure the most cost-effective design for each application.

TOA offers a range of modules to suit a variety of input and output requirements.

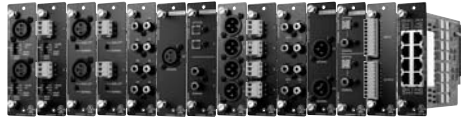

Mic/Line Input Modules

Monaural type

A/D Converter	XLR Connector	Removable Terminal Block Connector
24 bit	D-921F 2-Channel input module for mic and line inputs (selectable) with XLR connectors, adjustable input sensitivity, and phantom power.	D-921E 2-Channel input module for mic and line level inputs (selectable) with removable terminal block connectors, adjustable input sensitivity and phantom power.
	D-922F 2-Channel input module for mic and line inputs (selectable) with XLR connectors and DIP switches for input sensitivity, phantom power and ground lift.	D-922E 2-Channel input module for mic and line level inputs (selectable) with removable terminal block connectors, input sensitivity DIP switches, phantom power and ground lift.

Stereo type

D-936R

4 stereo input module equipped with standard RCA jacks. This module features two stereo transmission mode:

- 1) Selection of one of the four stereo inputs.
- 2) Mixing of all four stereo inputs, transmitting the mixed signal to the D-901 through left/right channel outputs.



Digital Input Modules

Applicable AES/EBU Format

D-923AE

2-Channel digital input module. With the use of this module, digital signals can be input, permitting direct connection of the D-901 to equipment having a digital output. Owing to the built-in sample rate converter, the module can handle signals of various sampling frequencies.



Applicable S/PDIF Format

D-937SP

Single channel stereo digital input module. With the use of this module, digital signals can be input, permitting direct connection of the D-901 to equipment having a digital output. Owing to the built-in sample rate converter, the module can handle signals of various sampling frequencies.



Line Output Modules

XLR Connector

D-971M

4-channel line outputs module equipped with XLR connectors.



Removable Terminal Block Connector

D-971E

4-channel line outputs module equipped with removable terminal block connectors.

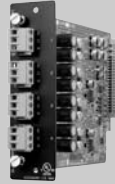

RCA Pin Jack Connector

D-971R

4-channel line outputs module equipped with standard RCA pin jack.



Digital Output Modules

Applicable AES/EBU Format

D-972AE

4-channel digital output module. With the use of this module, digital signals can be output, permitting direct connection of the D-901 to equipment having a digital input.



Applicable S/PDIF Format

D-961SP

2-Channel stereo digital output module. With the use of this module, digital signals can be output, permitting direct connection of the D-901 to equipment having a digital input.



Remote Control Module

8 inputs/8 outputs

D-981

For external remote control of memory presets, gain control, stereo input selection and channel ON/OFF operation plus tally outputs.



24 inputs/16 outputs

D-983

For external remote control of memory presets, gain control, stereo input selection and channel ON/OFF operation plus tally outputs.

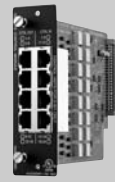

BLOCK DIAGRAM

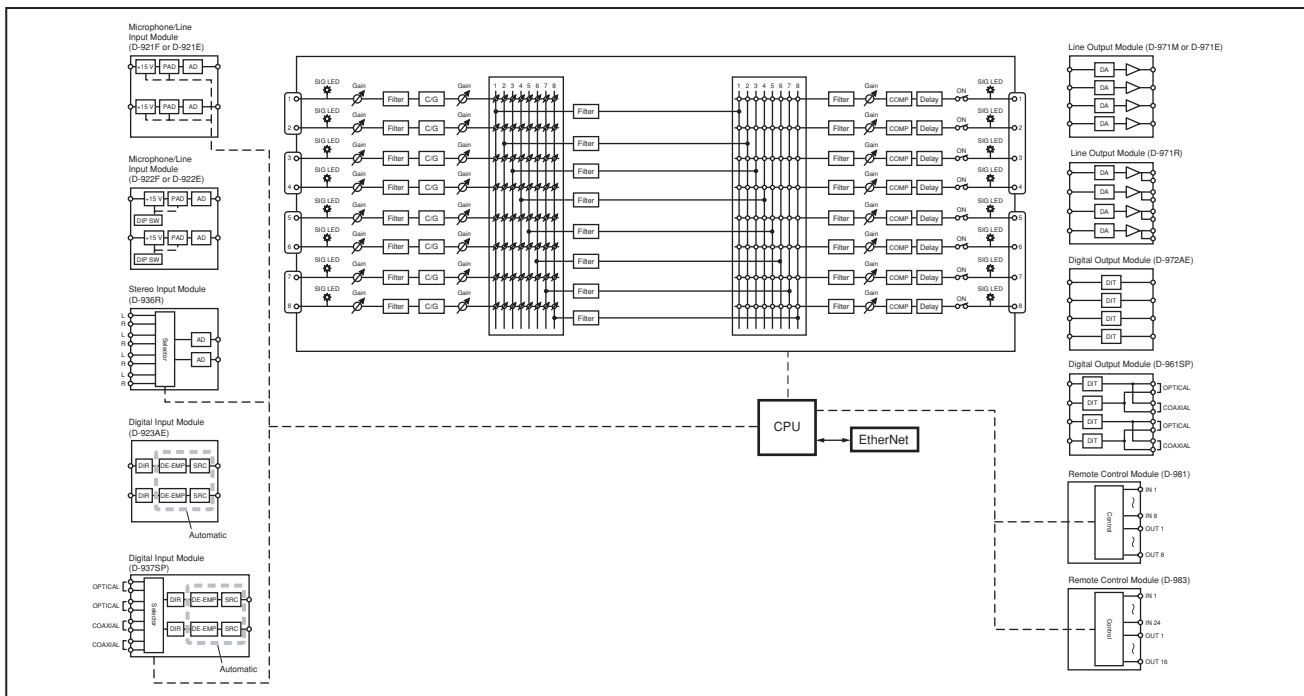

SPECIFICATIONS

Power Source	AC mains, 50/60Hz
Power Consumption	40W
Frequency Response	20 – 20,000Hz, ± 1 dB (+4dB* Input)
Input	Max. 8 channels, modular construction (modules optional)
Output	Max. 8 channels, modular construction (modules optional)
IO Configuration*²	2-IN/4-OUT, 2-IN/8-OUT, 4-IN/4-OUT, 4-IN/8-OUT, 6-IN/4-OUT, 6-IN/8-OUT, 8-IN/8-OUT
Signal Processing	
Automatic Resonance Control Function	Parametric equalizer: 20 – 20,000Hz, ± 12 dB, Q: 0.267 to 69.249
Level Control	$-\infty$ to +12dB (0.5dB steps), with polarity selector
Equalizer/Filter	Parametric equalizer: 20 – 20,000Hz, ± 12 dB, Q: 0.267 to 69.249 Filtering: High-pass filter: 20 – 20,000Hz, 6dB/oct, 12dB/oct Low-pass filter: 20 – 20,000Hz, 6dB/oct, 12dB/oct Notch filter: 20 – 20,000Hz, Q: 8.651 to 69.249 All-pass filter: 20 – 20,000Hz, Q : 0.267 to 69.249 High shelving filter: 6 – 20,000Hz, ± 12 dB Low shelving filter: 20 – 500Hz, ± 12 dB Horn equalizer: 20,000Hz, 0 to +18dB, (0.5dB steps) Crossover filter: 20 – 20,000Hz, 6dB/oct, 12dB/oct, 18dB/oct, 24dB/oct
Compressor	Threshold: -16 to +24dB* (1dB steps) Ratio: 1 : 1, 2 : 1, 3 : 1, 4 : 1, 8 : 1, 12 : 1, 20 : 1, ∞ : 1 Attack time: 0.02 to 100ms Release time: 10ms to 5s
Noise gate	Threshold: $-\infty$ to -26 dB* (1dB steps) Attack time: 0.1 to 100ms Release time: 20ms to 5s
Delay	Delay time: 0 to 682.0ms (0.021ms steps)
Matrix	8 \times 8 Level control: $-\infty$ to 0dB (1dB steps), with polarity selector
Preset memory	8
Auxiliary Function	Key lock function
Setting Software	OS: Windows* ³ 2000/XP Control system: 10 BASE-T/100 BASE-TX, Auto-negotiation, RJ45 connector
Front Panel Section	Preset memory recall knob: 1 Input indicator: Green LED Output indicator: Green LED
Module Slot (Rear Panel)	Input module slots: 4 Output module slots: 2 Remote control module slot: 1
Operating Temperature	+5°C to +40°C
Finish	Panel: Aluminum, hair-line finish, black Others: Pre-coated steel plate, black, 30% gloss
Dimensions	482.6 (W) \times 132.6 (H) \times 320 (D)mm (excluding projection)
Weight	7.4kg
Accessory	Power cord (2m) \times 1, Rack mounting bracket (preinstalled on the unit) \times 2, Rack mounting screw \times 4, Blank panel (preinstalled on the unit) \times 8, Module mounting screw (spare) \times 4, CD (software) \times 1
Option	Mic/Line input modules: D-921E, D-921F, D-922E, D-922F Stereo input module: D-936R Digital input modules: D-923AE, D-937SP Line output modules: D-971E, D-971M, D-971R Digital output modules: D-972AE, D-961SP Remote control modules: D-981, D-983

* 0 dB = 0.775 V

*² It is not possible to use 8-IN/4-OUT setting.

*³ Windows is a trademark of Microsoft Corporation.

Note: When installing the unit, never block the intake vents provided in the unit's bottom near the rear.