

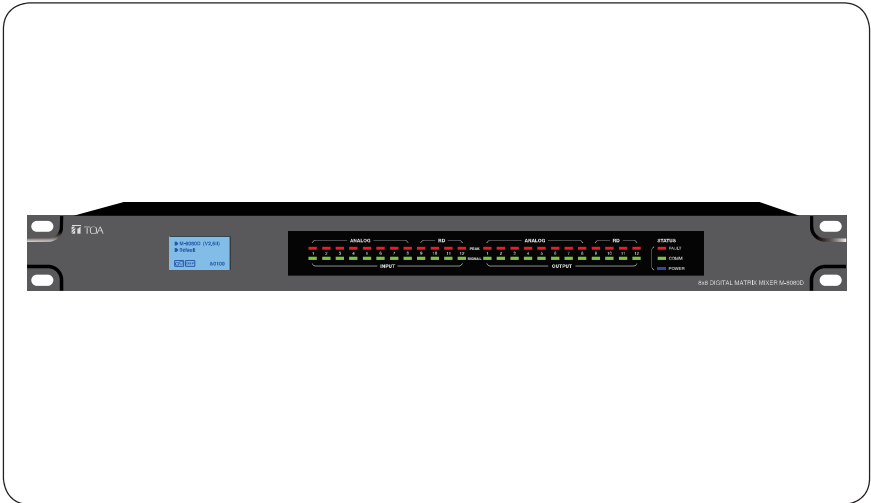

OPERATING INSTRUCTIONS

DIGITAL MATRIX MIXER SYSTEM M-8080D SERIES



Thank you for purchasing TOA's Digital Matrix Mixer System.
Please carefully follow the instructions in this manual to ensure long, trouble-free use of your equipment.

TOA Corporation

TABLE OF CONTENTS

1. IMPORTANT SAFETY INSTRUCTIONS	3
2. INTRODUCTION	6
3. MAIN FEATURES	6
3.1. DIGITAL MATRIX	6
3.2. DSP FUNCTIONS	7
3.3. NETWORKS	7
4. FRONT PANEL DESCRIPTION	9
5. REAR PANEL DESCRIPTION	10
6. M-8080D CONNECTION	12
7. SOFTWARE EDITOR	15
7.1. INPUT DSP CHANNEL	15
7.2. MATRIX	17
7.3. OUTPUT DSP CHANNEL	18
7.4. DUCKER	19
7.5. FBC (FEEDBACK COMPRESSION)	20
7.6. AUTO MIXER	22
7.7. SAVE / LOAD / COPY	23
7.8. SYSTEM	25
8. REMOTE DEVICES	28
8.1. M-800RM	28
8.2. M-800RC	31
8.3. M-802RC	33
8.4. M-822IO	35
8.5. M-800RCT	36
8.6. M-804EX	40
9. APPLICATION EXAMPLES	41
10. APPENDIX	44
11. SPECIFICATIONS	45
11.1. 8x8 DIGITAL MATRIX MIXER M-8080D	45
11.2. REMOTE MICROPHONE M-800RM	46
11.3. REMOTE AUDIO CONTROL PANEL M-800RC	46
11.4. REMOTE AUDIO CONTROL PANEL WITH AUDIO OUT M-802RC	47
11.5. REMOTE AUDIO INPUT OUTPUT PANEL M-822IO	47
11.6. REMOTE AUDIO CONTROL PANEL WITH TOUCH DISPLAY M-800RCT	48
11.7. EXTENSION MODULE 4 PORTS M-804EX	48

IMPORTANT SAFETY INSTRUCTIONS

- Read these instructions.
 - Keep these instructions.
 - Heed all warnings.
 - Follow all instructions.
 - Do not use this apparatus near water.
 - Clean only with dry cloth.
 - Do not block any ventilation openings. Install in accordance with the manufacturer's instructions.
 - Do not install near any heat sources such as radiators, heat registers, stoves, or other apparatus (including amplifiers) that produce heat.
 - Do not defeat the safety purpose of the polarized or grounding-type plug. A grounding type plug has two blades and a third grounding prong. If the provided plug does not fit into your outlet, consult an electrician for replacement of the obsolete outlet.
 - Protect the power cord from being walked on or pinched particularly at plugs, convenience receptacles, and the point where they exit from the apparatus.
 - Only use attachments/accessories specified by the manufacturer.
 - Use only with the cart, stand, tripod, bracket, or table specified by the manufacturer, or sold with the apparatus. When a cart is used, use caution when moving the cart/apparatus combination to avoid injury from tip-over.
- 
- Unplug this apparatus during lightning storms or when unused for long periods of time.
 - Refer all servicing to qualified service personnel. Servicing is required when the apparatus has been damaged in any way, such as power-supply cord or plug is damaged, liquid has been spilled or objects have fallen into the apparatus, the apparatus has been exposed to rain or moisture, does not operate normally, or has been dropped.

INSTRUCTIONS ESSENTIELLES POUR LA SÉCURITÉ

- Lire ces instructions.
 - Conserver ces instructions pour référence ultérieure.
 - Respecter tous les avertissements.
 - Suivre toutes les instructions.
 - Ne pas utiliser cet appareil à proximité d'eau.
 - Nettoyer uniquement à l'aide d'un chiffon sec.
 - Ne pas obstruer les orifices de ventilation. Installer conformément aux instructions du fabricant.
 - Ne pas installer à proximité de sources de chaleur telles que des radiateurs, des registres thermiques, des chaudières ou d'autres appareils (notamment des amplificateurs) produisant de la chaleur.
 - Ne pas contourner la fonction de sécurité de la fiche polarisée ou de mise à la terre. Une fiche de mise à la terre est équipée de deux broches et d'une troisième pour la mise à la terre. Si la fiche fournie ne peut être insérée dans la prise électrique souhaitée, consulter un électricien pour faire remplacer cette dernière.
 - Protéger le cordon d'alimentation pour éviter qu'il ne soit piétiné ou pincé, notamment au niveau des fiches, des prises de courant ou de son point de sortie de l'appareil.
 - Utiliser uniquement les accessoires spécifiés par le fabricant.
 - Utiliser uniquement avec le chariot, support, trépied, la patte de montage ou la table spécifiés par le fabricant ou vendus avec l'appareil. En cas d'utilisation d'un chariot, manipuler la combinaison chariot/appareil pour éviter les blessures dues à un renversement.
- 
- Débrancher cet appareil pendant les orages ainsi que lorsqu'il reste inutilisé pendant une période prolongée.
 - La maintenance de l'appareil doit être confiée à un technicien après-vente qualifié. Une maintenance s'avère nécessaire si l'appareil est endommagé (au niveau du cordon d'alimentation ou de la fiche), a été mouillé par un liquide, un objet est tombé à l'intérieur, s'il a été exposé à la pluie ou l'humidité, s'il ne fonctionne pas normalement ou s'il est tombé.

SAFETY PRECAUTIONS

- Before installation or use, be sure to carefully read all the instructions in this section for correct and safe operation.
- Be sure to follow all the precautionary instructions in this section, which contain important warnings and/or cautions regarding safety.
- After reading, keep this manual handy for future reference.

Safety Symbol and Message Conventions

Safety symbols and messages described below are used in this manual to prevent bodily injury and property damage which could result from mishandling. Before operating your product, read this manual first and understand the safety symbols and messages so you are thoroughly aware of the potential safety hazards.



The exclamation point within an equilateral triangle is intended to alert the user to the presence of important operation and maintenance (servicing) instruction in the literature accompanying the appliance.



Le point d'exclamation à l'intérieur d'un triangle équilatéral avertit l'utilisateur de l'existence d'instructions d'utilisation et d'entretien (réparation) dans la documentation fournie avec l'appareil.



WARNING

Indicates a potentially hazardous situation which, if mishandled, could result in death or serious personal injury.

When Installing the Unit

- **WARNING:** Do not expose the unit to rain or an environment where it may be splashed by water or other liquids, as doing so may result in fire or electric shock.
- Use the unit only with the voltage specified on the unit. Using a voltage higher than that which is specified may result in fire or electric shock.
- Do not cut, kink, otherwise damage nor modify the power supply cord. In addition, avoid using the power cord in close proximity to heaters, and never place heavy objects -- including the unit itself -- on the power cord, as doing so may result in fire or electric shock.
- Avoid installing or mounting the unit in unstable locations, such as on a rickety table or a slanted surface. Doing so may result in the unit falling down and causing personal injury and/or property damage.
- External wiring connected to the terminals marked with  requires installation by an instructed person.
- The apparatus shall be connected to a mains socket outlet with a protective earthing connection.
- L'appareil doit être branché à une prise d'alimentation avec mise à la terre de protection.
- The socket-outlet shall be installed near the equipment and the plug (disconnecting device) shall be easily accessible.
- The unit is not suitable for use in locations where children are likely to be present.

When the Unit is in Use

- Should the following irregularity be found during use, immediately switch off the power, disconnect the power supply plug from the AC outlet and contact your nearest TOA dealer. Make no further attempt to operate the unit in this condition as this may cause fire or electric shock.
 - If you detect smoke or a strange smell coming from the unit
 - If water or any metallic object gets into the unit
 - If the unit falls, or the unit case breaks
 - If the power supply cord is damaged (exposure of the core, disconnection, etc.)
 - If it is malfunctioning (no tone sounds.)
- To prevent a fire or electric shock, never open nor remove the unit case as there are high voltage components inside the unit. Refer all servicing to your nearest TOA dealer.
- Do not place cups, bowls, or other containers of liquid or metallic objects on top of the unit. If they accidentally spill into the unit, this may cause a fire or electric shock.
- Do not insert nor drop metallic objects or flammable materials in the ventilation slots of the unit's cover, as this may result in fire or electric shock.



CAUTION

Indicates a potentially hazardous situation which, if mishandled, could result in moderate or minor personal injury, and/or property damage.

When Installing the Unit

- Never plug in nor remove the power supply plug with wet hands, as doing so may cause electric shock.
- When unplugging the power supply cord, be sure to grasp the power supply plug; never pull on the cord itself. Operating the unit with a damaged power supply cord may cause a fire or electric shock.
- When moving the unit, be sure to remove its power supply cord from the wall outlet. Moving the unit with the power cord connected to the outlet may cause damage to the power cord, resulting in fire or electric shock. When removing the power cord, be sure to hold its plug to pull.
- Do not block the ventilation slots in the unit's cover. Doing so may cause heat to build up inside the unit and result in fire.
- Avoid installing the unit in humid or dusty locations, in locations exposed to the direct sunlight, near the heaters, or in locations generating sooty smoke or steam as doing otherwise may result in fire or electric shock.
- To avoid electric shocks, be sure to unplug the unit's power supply cord when connecting speakers.
- Be sure to follow the instructions below when rack-mounting the unit. Failure to do so may cause a fire or personal injury.
 - Install the equipment rack on a stable, hard floor. Fix it with anchor bolts or take other arrangements to prevent it from falling down.
 - When connecting the unit's power cord to an AC outlet, use the AC outlet with current capacity allowable to the unit.
 - No rack-mounting screws are supplied with the unit. Separately prepare the appropriate screws for the rack.

When the Unit is in Use

- Do not place heavy objects on the unit as this may cause it to fall or break which may result in personal injury and/or property damage. In addition, the object itself may fall off and cause injury and/or damage.
- Make sure that the volume control is set to minimum position before power is switched on. Loud noise produced at high volume when power is switched on can impair hearing.
- Do not operate the unit for an extended period of time with the sound distorting. This is an indication of a malfunction, which in turn can cause heat to generate and result in a fire.
- If dust accumulates on the power supply plug or in the wall AC outlet, a fire may result. Clean it periodically. In addition, insert the plug in the wall outlet securely.
- Switch off the power, and unplug the power supply plug from the AC outlet for safety purposes when cleaning or leaving the unit unused for 10 days or more. Doing otherwise may cause a fire or electric shock.



The lighting flash with arrowhead symbol, within an equilateral triangle, is intended to alert the user to the presence of uninsulated "dangerous voltage" within the product's enclosure that may be of sufficient magnitude to constitute a risk of electric shock to persons.



L'éclair accompagné d'un symbole représentant une pointe de flèche à l'intérieur d'un triangle équilatéral avertit l'utilisateur de la présence d'une "tension dangereuse" à l'intérieur de l'enceinte du téléviseur, dont la magnitude peut être suffisante pour constituer un risque de choc électrique pour les personnes.



ATTENTION

L'appareil ne doit pas être exposé aux éclaboussures ou écoulements et tous objets remplis de liquide, tels que vases, ne doivent pas être sur l'appareil.

2. INTRODUCTION

Thank you for purchasing the M-8080D series Digital Matrix Mixer System. This device is dedicated to music, paging, discussion and zone management solutions for Commercial Audio applications.

Easy to use and to implement, M-8080D offers state-of-the-art signal processing in a cost effective package.



M-8080D is a DIGITAL AUDIO PLATFORM for professional use. It can be used in following electromagnetic environment: residential, commercial and light industrial, urban outdoors. It is the apparatus intended for rack mounting.

3. MAIN FEATURES

3.1. DIGITAL MATRIX

Projects using DSP platforms usually require a minimum number of inputs and outputs.

This determines the choice of dedicated matrix models. M-8080D offers a large choice of I/O options in order to cover most of applications:

Audio I/O:

- Standard: 8 analogue IN / 8 analogue OUT on rear panel ports of **M-8080D**.
- Optional: 4 digital IN / 4 digital OUT via remote devices analog I/O.
- Max. System I/O: 12 x 12.

Optional remote devices with Audio I/O. Consumption on Audio I/O from devices in regards to additional available 4 digital IN / 4 digital OUT per **M-8080D**.

Remote devices	Audio IN	Audio OUT
M-800RM	2x	--
M-802RC	--	2x
M-822IO	2x	2x

Note:

- Only 2x devices of the above mentioned controllers can be connected physically to 1x **M-8080D** (available ports).
- 12x12 can be realized by using 2x **M-822IO**.
- Internal A/D conversion sampling rate 48kHz, Bit rate 24 bits.

3.2. DSP FUNCTIONS

M-8080D is intended for non-experts. The system used fix architecture for quick and easy operation. The intuitive GUI utilizes a familiar hardware-like layout to enable a short programming timeline and rapid hardware implementation.

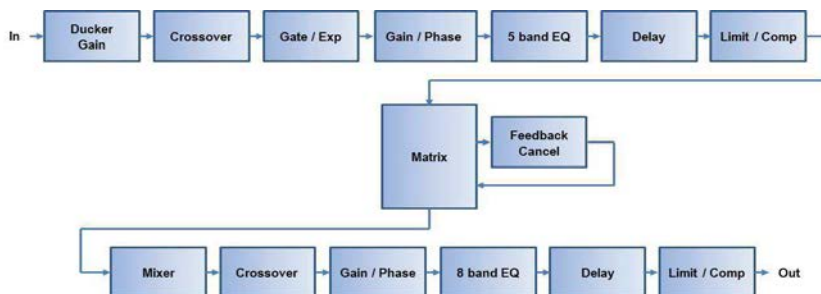

All functions can be configured with the PC Editor Software. Settings can be memorized for easy duplication or modification:

3.3. NETWORKS

M-8080D uses two types of network connections:

- **RD**, based on RS-485 for panel control and AES3 for digital audio transport.
- **TCP/IP** for LAN control.

Cable connections for Remote Controllers (RD ports)

Use shielded CAT 5e (or better) cable to connect the remote controllers to the RD ports. The maximum transmission distance is **100 meters**. If in wall-mounted controllers can be connected to the ground (except the Paging Station), the distance can be increased up to 150 meters.



CAUTION: Never connect a RD port to the router; this can cause damage to the devices.

The port can transmit and receive AES3 plus control signal, the following graphic illustrates the termination and also shows function of each wire pair on the network:

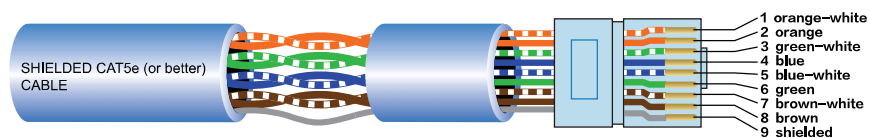

The green pair is reserved for data communications between **M-8080D** and remote device. Data communication is needed to send configuration information, software update and status information from **M-8080D** to remote device.

Note: Configuration information of remote device (such LED illuminate status, microphone sensitivity, channel name, etc.) is stored in **M-8080D**, not in the remote devices. This makes easy to swap for a new remote device without losing the configured information.

The orange and blue pairs carry two channels each of balanced differential AES3 digital audio. **TX** refers to audio that the remote device sends to **M-8080D**, **RX** refers to audio that remote device receives from **M-8080D**.

The brown pair provides 24VDC power and ground for the remote device.

Pins meaning of RD port:

- | | |
|-------------|-------------|
| 1- AES TX + | 5- RS485 RX |
| 2- AES TX- | 6- AES RX- |
| 3- AES RX+ | 7- DC24V |
| 4- RS485 TX | 8- GND |

Environment:

The M-8080D can be programmed by using the software editor available with the device. It works with Windows7 above.

Attention:

- a. In order to use the software. M-8080D and the PC must be in a LAN environment.
- b. At the moment, all must be connected to a network router by CAT5 cable.

Connection Example:

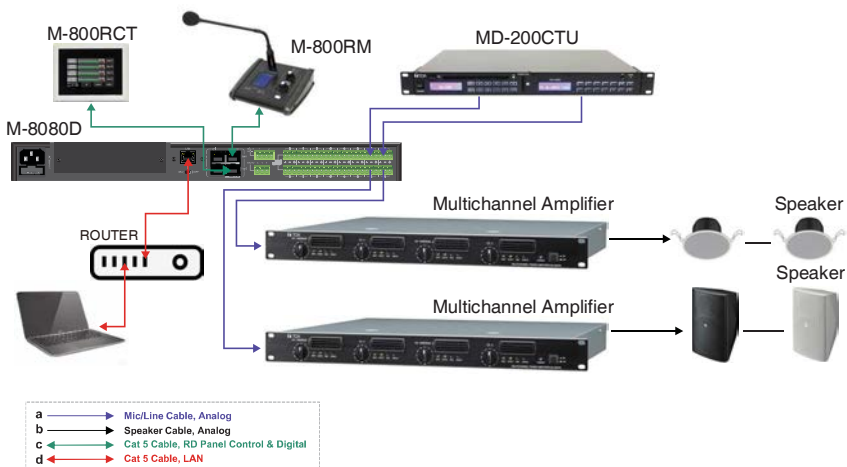

4. FRONT PANEL DESCRIPTION

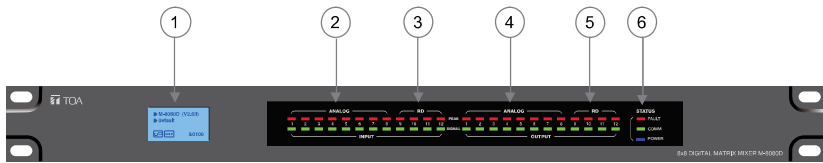

1. LC-Display

It displays device information. Such as name, firmware and ID. And communication status.

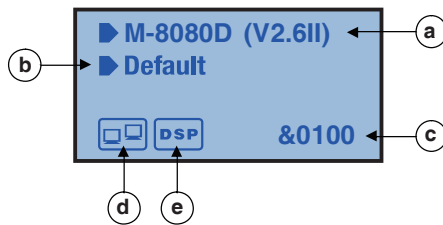

- Displays device name and the firmware version.
- It displays the current preset.
- Current ID. The ID is automatically obtained when the device is correctly connected. ID&0100
- Connection indicator between the PC and the device. If the connection is Okay. Both icons in the box will flash alternately.
- DSP connection indicator. In case of problem "DSP!" will be displayed.

2. ANALOG

Analog input indicators. The Green LED indicates presence of signal, the Red LED indicates signal clipping of the corresponding input.

3. RD

RD digital input indicators. The Green LED indicates presence of signal, the Red LED indicates signal clipping of the corresponding input.

4. ANALOG

Analog output indicators. The Green LED indicates presence of signal, the Red LED indicates signal clipping of the corresponding output.

5. RD

RD digital output indicators. The Green LED indicates presence of signal, the Red LED indicates signal clipping of the corresponding output.

6. STATUS

• FAULT

Red LED indicating a malfunction of the DSP. The information is relayed on the LC-Display.

• COMM

Green LED indicating the communication status between the PC and the device. The LED blinks during data transfer. It remains off in case of problems.

• POWER

Blue LED indicating that the unit is powered.

5. REAR PANEL DESCRIPTION

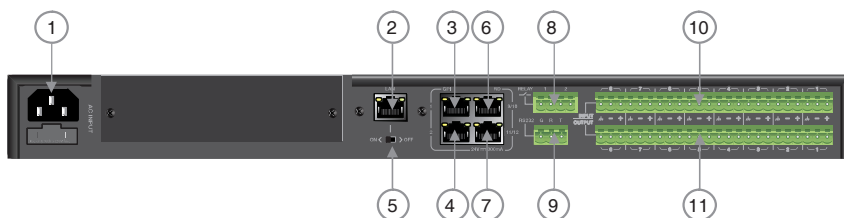

1. Power Socket

The power socket must be used with accessory cord.

The supply voltage is between 100 V and 240 VAC, 50-60 Hz, depending on countries.

The socket includes the fuse compartment. When changing it, make sure to replace it with a model of the same characteristics.

2. LAN

Port for the Ethernet connection, 10/100M adaptive, with DHCP function. The plug includes two LEDs, a green one indicating the good connection to the network and a yellow one indicating the good data transmission.

- If the yellow LED turns Off, there is a transmission problem. If On, with Green LED Off, the device has detected the network, but there is no connection.
- If the Green LED is on, the network connection is correct.

3. GPI 1 Port

This function is used to control the input / output priority / mute all outputs of channels 1-8, The details please see the Page 26.

4. GPI 2 Port

The function of this port is the same as that of GPI 1, The details please see the Page 26.

Note: The open voltage of GPI is 1.5V, and the open resistance is 200Ω. It is only used for relay or switch control.

5. ON/OFF SW

Switch on assign Ethernet to the LAN port .

6. RD 9/10

RD Port to connect remote device accessory such as **M-822IO**, **M-802RC**, **M-800RM**, **M-800RC**, **M-800RCT** and **M-804EX**.

This port transmits and receives AES3 digital audio plus control data.

M-822IO for instance, includes A/D and D/A converters for two I/O assigned to channels 9 and 10.

7. RD 11/12

Similar to port RD 9/10 (6) but assigned to channels 11 and 12.

About M-8080D RD port expansion:

Can use **M-804EX** / **M-800RCT** / **M-800RC** to expand the RD port of M-8080D.

Each **M-8080D** RD port can support up to 1pc **M-804EX** or 4pcs **M-800RCT** / **M-800RC**.

Note: 1x **M-804EX** can be added exclusively.

Application Examples

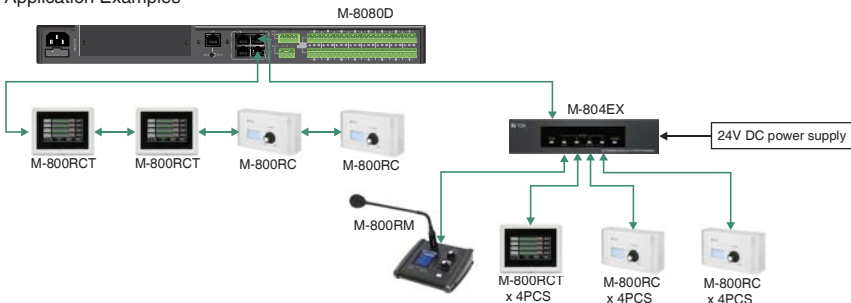

8. RELAY

Dry contacts where ON/OFF status can be individually controlled in the System menu (Please refer to page 23).

They are generally used as switches for third party electrical equipment.

Attention: withstand voltage: 24V DC, control current: Under 500mA.

9. RS232

This interface is used to remotely control **M-8080D** parameters, such as a Preset change or a modification of the gain for one channel.

Please refer to Appendix page 40 to consult the code table.

RS232 wire connection diagram



10. INPUT

Euroblock connector including 8 balanced analog inputs.

11. OUTPUT

Euroblock connector including 8 balanced analog outputs.

6. M-8080D CONNECTION

Software Function Introduction

Once the connection is completed. Open the **M-8080D** System Controller. The initial page shows as below:



Click Enter to open the software.

Attention:

- 1) After firmware is updated, the machine will automatically restart. After temporarily changing the router, it is recommended to restart the PC control software.
- 2) Regarding the IP address connection, it should use the internal LAN of the router, the router + PC should work with DHCP function.

1. System Introduction



Open: Load local preset files.

Save As: Save current preset to local, Press this button to save all current presets (except the preset list data).

Config Device ID: Customize device ID. The ID shall be always "0100" .

Offline Load: Only for TOA technicians to offline analyze whether the user preset files are correct.

Offline Save: Only for TOA technicians after offline editing, save preset to local.

Note: M-800RM (only) cannot save offline.

Exit: Quit the software.

Note: The Preset which was active before power off will be reloaded when power on the device.

2. Add Device Introduction

Click Add Device and select Add Online device. The system will automatically search for all online devices and appear in the list.



There are 7 kinds of machine in the Matrix system. You can select any device to input ID to view this device parameter (like Demo).

Attention:

M-8080D: The device can only enter 4 digits (ID with last two digits 0 and less than 8100).

M-800RM / M-822IO / M-802RC: The device can only enter 4 digits (The last two digits are 50, 60, 90, A0, B0, C0, D0, E0, and less than 81E0).

M-800RC / M-800RCT: The device can only enter 4 digits (Only the penultimate second digit is 5, 6, 9, A, B, C, D, E. The penultimate digit is less than 9 and less than 81E9).

Press Refresh to scan the devices.

After adding to the device list, enter the following page:

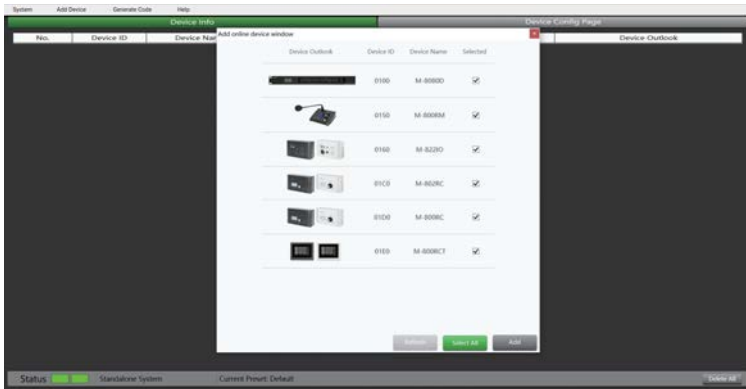

Refresh: Refresh the current online status of the device.

Select All: Select all current online devices

Add: Add the selected device to the device information list.

Selecting the device to add to the information list and enter the following page:

Device Info can clearly and intuitively see Device ID / Device Name / Status / Position Info / Device Outlook of all devices.

1) If you want to delete one of the device. First select the left button, then click the right button, the word Delete will appear. Then left click on Delete to delete easily.



2) If you want to delete all online devices at once, please click Delete All in the lower right corner of the software.

3. Generate Code

The screenshot shows the 'Generate Code' software interface. At the top, there are tabs for 'System', 'Add Device', 'Generate Code', and 'Help'. Below the tabs is a 'Device Listing Page' table with the following data:

No.	Device ID	Device Name	Status	Position Info	Device Outlook
1	0100	M-8080D	Common Fault		
2	0150	M-8080M	Common	Connected to the RD1(N/10) port of M-8080D 0100	
3	0160	M-8220C	Common	Connected to the RD2(1/1/2) port of M-8080D 0100	
4	01C0	M-802RC	Common	Connected to the RD2(1/1/2) port of M-8080D 0100	
5	01D0	M-808RC	Common	Connected to the RD2(1/1/2) port of M-8080D 0100	
6	01E0	M-808RC1	Common	Connected to the RD2(1/1/2) port of M-8080D 0100	

At the bottom of the interface, there is a status bar with a 'Status' indicator (green), 'Standard System', 'Current Preset: Default', a numeric keypad (01-99), and a 'Generate' button.

When performing any function operation, press this button and the corresponding command will be displayed below the software.

4. Help

The screenshot shows the 'Help' software interface. At the top, there are tabs for 'System', 'Add Device', 'Generate Code', and 'Help'. Below the tabs is a 'Device Listing Page' table with the same data as in the previous screenshot:

No.	Device ID	Device Name	Status	Position Info	Device Outlook
1	0100	M-8080D	Common Fault		
2	0150	M-8080M	Common	Connected to the RD1(N/10) port of M-8080D 0100	
3	0160	M-8220C	Common	Connected to the RD2(1/1/2) port of M-8080D 0100	
4	01C0	M-802RC	Common	Connected to the RD2(1/1/2) port of M-8080D 0100	
5	01D0	M-808RC	Common	Connected to the RD2(1/1/2) port of M-8080D 0100	
6	01E0	M-808RC1	Common	Connected to the RD2(1/1/2) port of M-8080D 0100	

Click the Help , a pop-up window will display the information of the current software.

7. SOFTWARE EDITOR

7.1. INPUT DSP CHANNEL

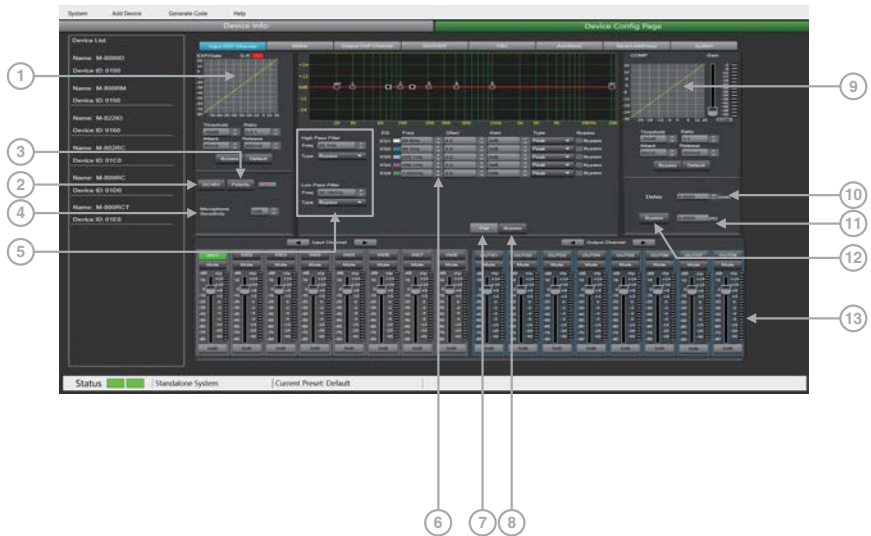

1. EXP/Gate: The gate attenuates signals below the threshold value, and allows signals above the threshold value to pass. When the signal is beyond the threshold, the output signal remains identical to the input signal. By adjusting the value of the ratio to its maximum, the Expander is transformed into a Noise Gate.

Threshold: -80dB to +20dB.

Click this button to set the noise gate trigger level of the selected channel.

Ratio: Gain ratio between the input signal and the amplified signal, from 1:1 to 10:1

Attack: reaction time when the signal is above the specified threshold, from 10 to 150 ms.

The attack time is how long it takes the gate to fully open once this threshold has been reached.

Release: reaction time of the Expander when the signal passes below the specified threshold from 10ms to 1000 ms.

Bypass: Press this button, the function of this area is invalid.

Default: Restore this area to default settings.

2. DC48V: Note this button is only used for external condenser microphone, otherwise it may damage your device, 48V phantom power for electric microphone.

3. Polarity: inverts the phase of the signal by 180°.

4. Microphone Sensitivity: Input sensitivity for a microphone, from -48dB to 0dB.

5. EQ: High Pass Filter and Low Pass Filter: Those filters are used to eliminate non necessary frequencies above and below the signal spectrum, in order to avoid any background noise generation due to multi-processing. For instance, a voice microphone will be set to 100Hz for the High Pass and 4kHz for the Low Pass.

Freq: Cut-off frequency

Type: Filter type

6. Parametric EQ

The equalizer is used to compensate or alter the spectral characteristics of the signal in order to obtain the flattest possible frequency response. The module here is a parametric 5 bands EQ.

a) Freq: central frequency of the filter between 19.7Hz and 20.16kHz.

b) Qfact: selectivity of the filter(Q). Greater is the value, thinner is the processed part of the spectrum. Can be adjusted from 0.4 to 128.

c) Gain: Gain or attenuation of the center frequency, from -18dB to +18dB.

d) Type: Filter type, Peak / Low / High.

e) Bypass 1~5: temporarily cancels the individual processing of filters 1~5 without having to use the general 'Bypass'.

7. Flat: All parameters are reset to the factory settings.

8. Bypass: the signal is not processed and skips to the next processing module.

Filters can be set manually by entering alphanumeric values, or graphically by clicking directly on the frequency response diagram and moving the mouse while holding the button pressed.

9. Comp:

A compressor can limit the dynamics of a signal beyond a certain level. When the signal exceeds the Threshold it is compressed in a ratio greater than 1. Below the Threshold, input and output signals remain the same. By adjusting the ratio to its maximum value, the compressor is transformed into a limiter.

a) Threshold: Threshold from which the signal is compressed, from -30dB to +20dB.

b) Ratio: Compression ratio. For instance, a 4:1 ratio means that the input level is 4dB above the threshold, the output signal will be 1dB above this threshold. The ratio value can be set from 10:1 to 1:1.

c) Attack: Reaction time of the compressor when the signal is beyond the specified threshold. From 10 to 150ms.

d) Release: Reaction time of the Compressor when the signal is below the specified threshold, from 10ms to 1000ms.

e) Bypass: Press this button, this area function is invalid.

f) Default: Restore Compressor parameters to default.

g) Gain: Adjust the volume level after passing the compressor.

10. Delay: A delay can be set for each input up to 1361.2916ms. It can be used for sound/video synchrono applications or phase adjustment.

11. m means step: It adjust the delay distance according to the actual location of multiple audio sets.

12. Bypass: The signal is not processed and skips to the next processing module.

13. Input / Output channel

a) Activation (IN/OUT): Activate the Input/Output to edit the functions.

You will be automatically routed to Input/Output DSP Channel.

b) Mute: Mute the signal.

c) Fader: Adjust the volume of this channel.

d) How to modify the channel's name.

- Double click the channel's name.

- Input the individual name you want to modified.

- Press "Enter" button on the keyboard.

Attention: In case of **M-800RCT**, the individual name setting is not transmitted automatically to the device. Use the separate Setting page of **M-800RCT** for setting individual names to be transmitted and indicated on **M-800RCT**.

Function Example:



Adjusting the high-pass filter to 32.7Hz. Type is adjusted to BW24. Drag EQ1 to 54.4Hz and adjust the Q value to 2.0. Gain up to 8dB. Drag EQ2 to 315Hz. Q value is adjusted to 2.5. Gain to 2.5dB. EQ3 type to 1.45kHz The Q value is unchanged. The gain is attenuated to -2.5dB. The EQ4 type is adjusted to 406.1Hz. The Q value / gain is unchanged, and the EQ5 type is adjusted to 8.38KHz. The Q value does not change and the gain reaches 4dB.

7.2. MATRIX



This part of the software is used to route inputs through a graphical representation as a matrix. By clicking on the gray boxes several inputs can be assigned to several outputs. If the connection is active the box turns green, otherwise it remains gray.

The matrix can route 12 input signals to 12 separate outputs. One talks about a 12x12 matrix.

IN(OUT) 01 to IN(OUT) 08 are analog I/O available on the rear panel.
 In(OUT) 09 to IN(OUT) 12 are digital I/O (RD ports) and are converted to analog signals.

Attention:

After the M-800RM is connected, the corresponding output is automatically turned off . The purpose is to avoid: no broadcast but also has output.

Function Example:



Assign input 1 to output 1, when the sound is adjusted to -29dB, press OK. The sound of channel 1 will be adjusted to -29dB.

7.3. OUTPUT DSP CHANNEL



Same menu as the Input DSP Channel ,without the Expander/Gate section. The parametric EQ features 8 bands here, instead of 5 bands for the inputs. Please refer to the introduction of **Input DSP Channel**.

Function Example:



Adjust the high-pass filter / EQ point to the corresponding parameter, which is the same as Input DSP. The waveform in the EQ diagram will also change accordingly.

7.4. DUCKER

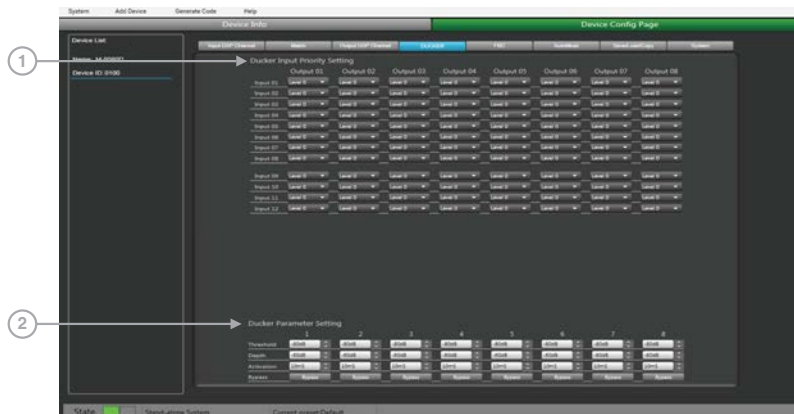

The principle of the Ducker is to attenuate one or several channels when priority signals are activated. The main applications are automatic speech for conference or priority messages. E.g. Use the host microphone signal to control the background music volume. The host automatically reduces the background music volume when speaking. After the speech, the volume of BGM music is automatically restored.

1. Ducker Input Priority Setting

Each input corresponds to each output. This area is used to set the priority of input audio 0 - 15. Higher level (higher number) has higher priority. The highest level is 15.

2. Ducker Parameter Setting

Threshold: threshold of attenuation. From 0dB to -80dB.

Depth: depth of attenuation.

Activation Time: Velocity of gain change to attenuate inputs.

BYPASS: The signal is not processed and skips to the next processing module.

Function Example:

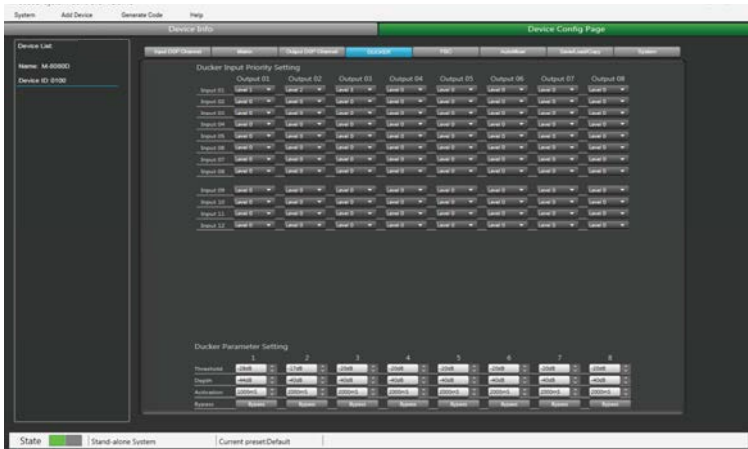

The current setting sets channel 1 to level 1, channel 2 to level 2, and channel 3 to level 3. At the same time, the Threshold, depth, and Active time are set at the bottom of the page. The audio source will be output according to the previously set priority and other parameters.

7.5. FBC (FEEDBACK COMPRESSION)



FBC (Feedback compression) function can effectively suppress howling expansion volume, ensure voice transmission quality, high fidelity, and clear sound.

The dynamic filter and the static filter function the same. Used to remove devices above or below a certain frequency.

To increase or decrease a range of frequencies in sound by passing them through. The differences between them are:

1. Static filters do not clear filters like dynamic filters. The frequency points that have been captured are fixed in position.
2. The dynamic filter will be automatically eliminated, and the captured frequency is not fixed.

Even in poor environments, it can greatly suppress the howling and can effectively prevent burn out audio equipment and speakers.

1. FBC input Select

There are 12 inputs to choose from. When the corresponding input is lit, the filter of this channel will work. The default is a dynamic filter. The 1-24 light will turn green.

2. FBC Output Assign

There are 12 outputs to choose from. When the corresponding output is lit, the filter of this channel will work. The default is a dynamic filter. The 1-24 light will turn green.

FBC Setting:

3. FBC Mode: Speech & Music is suitable for meetings and music occasions, howling and clearing are automatically captured.

4. Filter Release: Fast / Mid / Low. Click here to determine the speed of dynamic filter elimination. Fast / Mid / Slow.

FBC Setup:

5. Static Filters Setup: The default is a dynamic filter (the indicator is green). Click Static Filter Setup to switch to static filter (the indicator light is red).

6. Clear Dynamic Filters: Initialize all dynamic filters.

The automatic elimination time of dynamic filter has time limit of 2s-3s.

At this time, you can press this button to remove immediately.

7. Clear All Filters: Initialize all dynamic and static filters.

8. Bypass: Bypass this area function.

9. 1 - 24 indicators: Once the system detects the frequency for processing, if it is set as a static filter, the indicator boxes 1 to 24 turn red, and the filtering effect is reflected on the graph. For dynamic filters, attenuation will also appear in the graph and indicator box lit in green.

Attention: Because the **M-800RM** are used for broadcast, The input RD9/10 of FBC page would cancel automatically when **M-800RM** insert to RD9/10. The FBC function has no effect at this point.

After the M-800RM is connected, the corresponding output is automatically turned off . The purpose is to avoid: no broadcast but also has output.

Function Example:



Turn on local input / output 1. The corresponding input signal is sent to the FBC module for processing, and the corresponding button is lit to output the signal after FBC processing to the corresponding output channel. Click "Static Filter Setting" to enter the static filter setting mode.

Set the volume of all input channels to the required level and turn on the microphone. Manually gain FBC until howling occurs, in this mode the FBC module will automatically use a static filter. (Static filter indicator is red)

7.6. AUTO MIXER



The Auto mixer automatically controls the gains of multiple microphones in real time, dramatically reducing feedback, noise and comb-filtering from adjacent microphones. It maintains a consistent system gain, even when multiple speakers are talking simultaneously, and makes perfectly matched crossfades, without any signal compression.

Source Select

Local Input: selection of input channels (1-12) to be processed.

Activation Time

Set the start mixing time of the signal of the selected input channel.

Push ON to activate the time setting, and use the horizontal fader to set the time value.

Function Example:



Add the local input CH 1 and CH2 open setting to the automatic mixing function. Input the audio source from two channels. Click the ON button of Active Time and push the fader to set the start mixing time of the CH 1 and CH2 signal. For example, drag the fader to 900ms, the sound source of channel 1 will be at 900ms, and the mixing function is added.

7.7. SAVE / LOAD / COPY



This menu is used to manage the backup parameters. These data can be stored directly in the internal memory of host as a preset. Its memory contains a total of 16 presets.

1. Import All Preset: Import all preset types from device to computer file.

2. Export All Preset: Export all preset types from computer to device.

3. Preset List: The preset list shows all saved presets. The status below shows the current operating status.

4. Device / Local PC

Note: 1. System save (save all parameters except preset list) and ROM (M-8080D stand-alone preset saving), it need to be saved separately.

2. After the system preset is exported, it will be overwritten when reloaded.

a) If Device is selected

-**Load:** First to select a preset, click OK to load, wait a few seconds until finished.

-**Save:** Select a preset in the preset list, then customize the name, Click Save button, and the modification will be successful.

-**Delete:** Select a preset and click Delete, the preset will be deleted.

b) When Local PC is selected

-**Load:** Select Local PC and click Load, indicating that the preset will be loaded locally from the computer.

-**Save:** When Local PC is selected, click Save to save the current preset to the computer.

5. Channel Copy

Input / output channels (1~12) can be selected and copied to any channel (1~8) in the check box.

Select All: Click this button, all CH1~CH8 will be selected

Copy: After selecting the input / output channel to any other channel, click Copy, and the parameter copy is successful.

Function Example:



Save current preset to device

- 1) Select Device and click Save button.
- 2) Enter the preset name in the pop-up window.
- 3) Click Submit button to save the preset.

Note:The preset list are saved separately and are not included in the system saving.

Function Example 2:



Select the input channel Input1 to copy to CH03. Click the COPY button, the parameters of input channel 1 will be copied to CH03.

7.8. SYSTEM

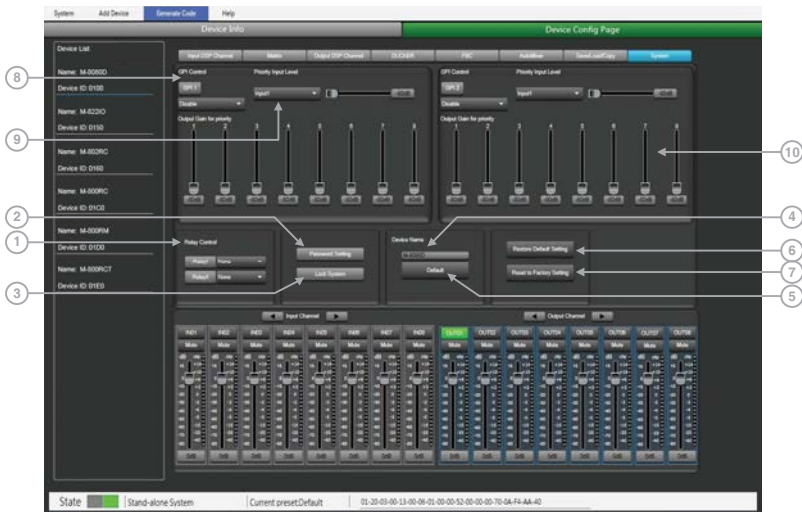

1. **Relay Control:** It is used to control external devices. Allow end users to control their actions.
2. **Password Setting:** Press this button to modify the password.
3. **Lock System:** Press this button to lock the system. It is locked at this time, you need to enter the password to unlock, if you forget the password, you can use the super password MA88 to unlock.
4. **Device Name:** You can customize the device name here. After modification, press the Enter key to easily set.
5. **Default:** Change device name to default setting **M-8080D**.
6. **Restore Default Setting:** Restore all setting to default settings.
7. **Reset to Factory Setting:** Clear all settings, include default settings.

8. GPI Control:

For easy control of I/O priority (GPI function is top priority) and the volume of the selected I/O.

Note: The open voltage of GPI is 1.5V, and the open resistance is 200Ω. It is only used for relay or switch control.

Wire drawing (GPI 1 short)

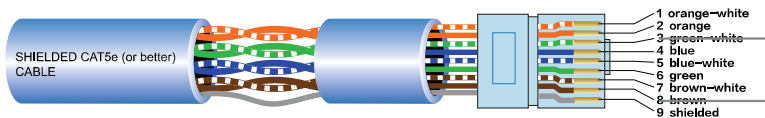

- 1) Put the cable insert to the GPI 1 port in the back plate.
- 2) The other end connects the green-white wire and the brown wire in the network cable to form a short circuit.
- 3) The GPI light on the software will automatically light up(green), which means that it is enabled.
- 4) Set priority type according to demand.

Wire drawing(GPI 2 short)

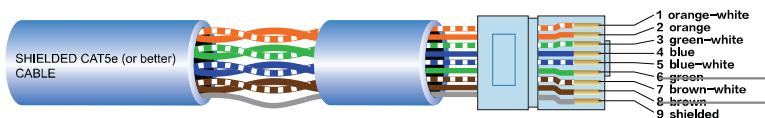

- 1) Put the cable insert to the GPI 2 port in the back plate.
- 2) The other end connects the green wire and the brown wire in the network cable to form a short circuit.
- 3) The GPI light on the software will automatically light up(green), which means that it is enabled.
- 4) Set priority type according to demand.

9. **Priority Input Level:** Select input 1-8 for priority control.

10. **Output gain for priority:** It used to control the output gain of the priority channel.

Function Example 1:



Click Password Setting, enter the current password and the password you want to modify, click Confirm, the password will be successfully modified.

Function Example 2:



- 1) According to the method described earlier, insert one end of the network cable into the GPI 1 port on the rear panel of the machine, and the other end is short-circuited.
- 2) The GPI 1 port on the PC software lights up to indicate that this function is enabled.
- 3) According to the set input priority and the selected input 1. At this point, only the input 1 input signal has output.

8. REMOTE DEVICES

M-8080D offers a large choice of devices for volume adjustment, paging management, routing and I/O modules.

8.1. M-800RM



The **M-800RM** is a Paging Microphone and can address 1 to 12 different zones (outputs). Moreover, a total of 2 x **M-800RM** can be used in a system, which makes a lot of possibilities for message paging.

M-800RM requires/consumes 2x digital input channels of in total 4 available digital Input Channels of **M-8080D**.

a. LC-Display

It displays the selected zones, the volume and ID number.

b. Signal status indicators

The green LED indicates the presence of signal when the microphone is ON. The red LED indicates the limit of clipping.

c. Communication status indicators

When the communication with the **M-8080D** is correct, the green LED blinks. In case of problem, the BUSY red LED lights up.

d. Volume control and all zone selector

It controls the volume of the microphone for each selected zones. By pushing on the button, it selects all zones.

e. Zone selector

It selects one or several zones by turning the button left or right and pushing on it to validate.

f. Push-to-talk switch

When the button is pushed, the chime sounds and the red ring on the microphone lights up indicating that one can talk.



g. XLR connector

Female 3 pin XLR connector for the gooseneck electret microphone. It uses a phantom power controlled by software.

h. USB port

This port is used to load WAV / MP3 files for chimes sound. The maximum time for the chimes is 4 seconds.

WAV vs. MP3

Available Bit Rates: 8 ~ 128 kbps, sampling rates: 8 ~ 44.1 kHz.

About How to transfer chimes to the M-800RM

1. Using a USB cable to connect the USB port on the rear panel of the machine to the computer.
2. Open My computer will display a removable storage disk.
3. Drag the chimes you want into the Removable disk to complete the USB audio import

Caution: The maximum storage space of the device is 1MB.

i. RD port

Connection to the **M-8080D**. The maximum CAT 5e cable length is 100 meters.

Attention:

- 1) **M-800RM / M-822IO / M-802RC** (with audio transmission) can only be connected to the RD port of the **M-8080D** or the RD EXP port 1 of **M-804EX**.
- 2) **M-800RC / M-800RCT** (with control function) can link each other.

Note:

- 1) No hot plugging, The connection must be made when the system power is off.
- 2) **M-800RM / M-822IO / M-802RC** (with audio transmission) can only be connected to the RD port of the **M-8080D** or the RD EXP port 1 of **M-804EX**.
- 3) **M-800RC/M-800RCT** (with control function) can link each other.

M-800RM Editor



This function is a partition setting, with audio routing function, can control up to 12 partitions. Distribute audio to different partitions, and easily manage partitions by adjusting the sending time / volume / priority.

1. Connect Status: When the signal light shows green, it means the communication status is normal. If it shows gray, it means no communication.

2. Screensaver: When this box is checked, the machine will enter the sleep state if there is no operation for one minute.

Note: The factory setting is ON. In order to prolong the life of the LC-Display, it is recommended that the user set it to ON.

3. Clear All: Clear all output areas at once.

4. Select All: Select all output areas at once.

5. Device Name: The default name is displayed in the box. click to modify the device name, click Save To Device to modify successfully.

6. Chime Time: Chime playing time. The interval is: 0.1S~12S.

7. Master Volume: Audio master volume adjustment. The volume level is: 0~32dB.

8. Chime Volume: Control the playback volume of audio files, the volume level is 0~32dB.

9. Mic Volume: Microphone volume adjustment. The volume level is 0~32dB.

10. Priority: Priority setting. The priority level is: 1-16. Higher level (higher number) has higher priority.

11. Load from Device: Load presets from device to PC.

12. Save To Device: Save current preset to the device.

13. Default: Initialize preset parameters.

14. Load from PC: Load selected preset from PC.

15. Save to PC: Save current preset to PC.

16. Lock System: Enter numbers and letters as password and click lock. If he forgets the password and is locked, he can use the factory password 0000 to unlock it.

Note: After unlocking, no other password can be set. You must first lock and then unlock with 0000 to set a new lock password.

17. Max Zone Setting: Maximum 64 partitions can be set and managed.

18. Zone Setting: Users can set up and manage 1-64 partitions, select 1-12 outputs.

8.2. M-800RC



This volume controller can be assigned to any output of the **M-8080D**. It can also route any input to any output like in the Matrix menu of the Editor Software.

a. LC-Display

It displays the volume level and the signal level for a dedicated output.

b. Volume and routing control

Turn the button left or right to adjust the volume.

Push the button to access to the inputs and outputs routing menu.

c. RD IN

Connection to **M-8080D** or **M-804EX**.

The maximum CAT 5e cable length is **100 meters**.

d. RD EXP

Daisy connection for additional remote controller (4 controllers max).

The maximum CAT 5e cable length for daisy chain **100 meters** in total from **M-8080D** RD port to last controller.

Attention:

- 1) **M-800RM / M-822IO / M-802RC** (with audio transmission) can only be connected to the RD port of the **M-8080D** or the RD EXP port 1 of **M-804EX**.
- 2) **M-800RC / M-800RCT** (with control function) can link each other.

Wall installation instructions:

1. First unscrew the screw on the bottom of the device with a screwdriver.
2. Fix the back plate to the wall. Screw both ends to the wall. Check for firmness or crooked nails.
3. Insert the distributed network cable into the RD IN port, and snap the device to the back plate. Tighten the bottom with screws.
4. Cover the decorative panel.

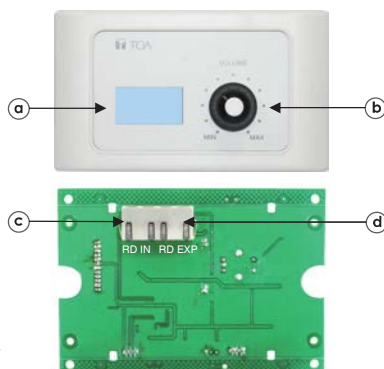

M-800RC Editor

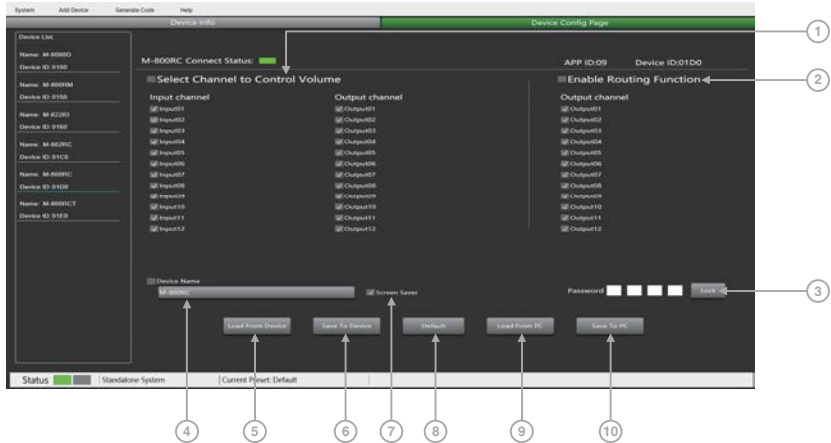

1. Select Channel to Control Volume

- Input Channel 1 - 12: Check the box to control the input of multiple channels at once.
- Output Channel 1 - 12: Check the box to control the output of multiple channels at once.

2. Enable Routing Function:

- Output Channel 1 - 12: Check the box to control the routing of output channels 1-12.

3. Lock System: The user can enter numbers and letters as password and click lock. If he forget the password that can use factory password: 0000.

Note: After unlocking, no other password can be set. You must first lock and then unlock with 0000 to set a new lock password.

4. Device Name Setting: Click the box to modify it, and click Save To Device to save successfully.

5. Load From Device: Load presets from device.

6. Save To Device: Save the current parameters to the device.

7. Screen Saver: After checking this box, the machine will sleep after one minute of inactivity.

Note: The factory setting is ON. In order to prolong the life of the LC-Display, it is recommended that the user set it to ON.

8. Default: Restore the default preset.

9. Load From PC: Load presets from PC.

10. Save To PC: Save current preset.

Attention: The volume can only be switched on the terminal after the PC software is set, and the volume cannot be adjusted on the terminal.

8.3. M-802RC



The **M-802RC** has the same functionality as the **M-800RC** volume control, but it includes 2 additional analog outputs. The device includes a built-in D/A converter processing digital audio AES3 signals from **M-8080D**.

M-802RC requires/consumes 2x digital output channels of in total 4 available digital output channels of **M-8080D**.

a. LC-Display

It displays the volume level and the signal level for a dedicated output.

b. Volume and routing control

Turn the button left or right to adjust the volume.

Push the button to access to the inputs and outputs routing function.

c. RD IN

Connection to **M-8080D** or **M-804EX**. The maximum CAT 5e cable length is **100 meters**.

Attention:

- 1) **M-800RM / M-822IO / M-802RC** (with audio transmission) can only be connected to the RD port of the **M-8080D** or the RD EXP port 1 of **M-804EX**.
- 2) **M-800RC / M-800RCT** (with control function) can link each other.

d. Analog OUT

2 channel analog line Outputs assigned to RD port 9 / 10 or 11 / 12 of **M-8080D**.

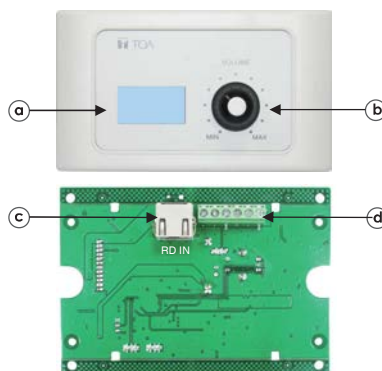

Wall installation instructions:

1. First unscrew the screw on the bottom of the device with a screwdriver.
2. Fix the back plate to the wall. Screw both ends to the wall. Check for firmness or crooked nails.
3. Insert the distributed network cable into the RD IN port, Connect the analog output cable, and snap the device to the back plate. Tighten the bottom with screws.
4. Cover the decorative panel.

M-802RC Editor

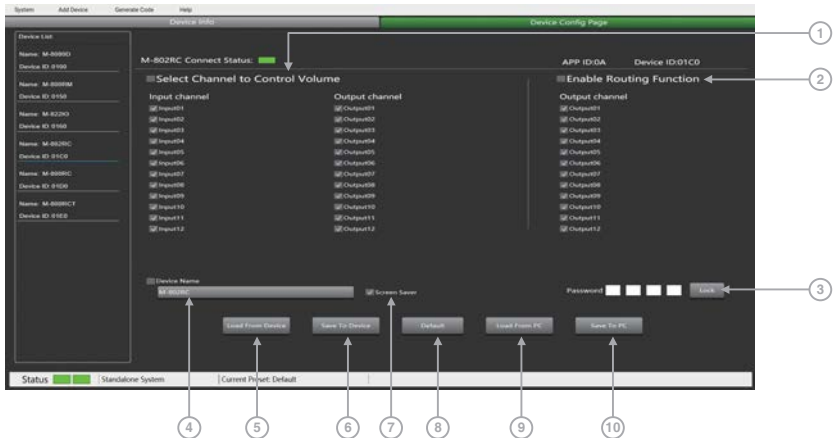

1. Select Channel to Control Volume:

-**Input Channel:** Check the box to control the input of multiple channels at once.

-**Output Channel:** Check the box to control the input of multiple channels at once.

2. Enable Routing Function

-**Output Channel 1 - 12:** Check the box to control the routing of multiple output channels at once.

3. Lock System: The user can enter numbers and letters as password and click lock. If he forget the password that can use factory password: 0000.

Note: No other password can be set after unlocking, you must first lock and then unlock with 0000 to set a new lock password.

4. Device Name Setting: Click to modify the device name, after modification, click Save To Device to save.

5. Load From Device: Load presets from device.

6. Save to Device: Save preset parameters to the device.

7. Screen Saver: After checking this box, the machine will sleep after one minute of inactivity.

Note: The factory setting is ON. In order to prolong the life of the LC-Display, it is recommended that the user set it to ON.

8. Default: Initialization parameter setting.

9. Load From PC: Load presets from PC.

10. Save To PC: Save current preset.

Attention: The volume can only be switched on the terminal after the PC software is set, and the volume cannot be adjusted on the terminal

8.4. M-822IO



The **M-822IO** is a remote audio input and output module providing 2 x analog channels IN and 2 x analog channels OUT. The device includes built-in A/D and D/A converters processing digital audio AES3 signals from and to the **M-8080D**.

M-822IO requires/consumes 2x digital input + 2x digital output channels. In total 4 available Inputs and 4 available output channels can be occupied.

a. 2 Channel Inputs

A & B analog line Inputs assigned to channels 9/10 or 11/12 of **M-8080D**.

b. Microphone Input

XLR connector for MIC. If connected, it replaces the A channel input.

c. Microphone volume

Button to adjust the MIC input level.

d. Phantom power

48V switchable phantom power for electret MIC.

e. Signal indicators for the Inputs

Channel A (MIC) and B input signal status indicators for signal presence and clip.

f. Signal indicators for the Outputs

RD port 9 / 10 or 11 / 12 output input signal status indicators.

g. RD IN

Connection to **M-8080D** or **M-804EX**. The maximum CAT 5e cable length is **100 meters**.

Attention:

- 1) **M-800RM / M-822IO / M-802RC** (with audio transmission) can only be connected to the RD port of the **M-8080D** or the RD EXP port 1 of **M-804EX**.
- 2) **M-800RC / M-800RCT** (with control function) can link each other.

h. 2 Channel Outputs

2 channel analog line Outputs assigned to RD port 9 / 10 or 11 / 12 of **M-8080D**.

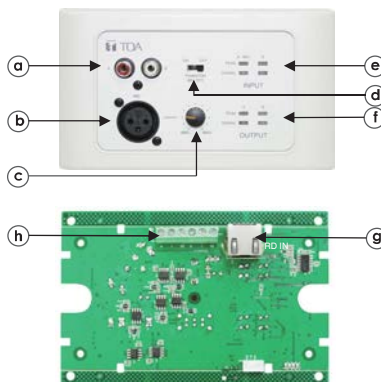

Wall installation instructions:

1. First unscrew the screw on the bottom of the device with a screwdriver.
2. Fix the back plate to the wall. Screw both ends to the wall. Check for firmness or crooked nails.
3. Insert the distributed network cable into the RD IN port, Connect the analog output cable, and snap the device to the back plate. Tighten the bottom with screws.
4. Cover the decorative panel.

M-822IO Editor



Device Name Setting: Click to start modifying the name, and click Save to modify the name successfully.

Save: Save preset parameters.

Default: Initialization parameter preset.

8.5. M-800RCT



The **M-800RCT** is a wall mount 4.3" touch LC-Display volume controller.

The volume control can be assigned to any output of the **M-8080D**. It can also route any input to any output like in Matrix menu of the Editor Software.

a. RD IN

Connection to **M-8080D** or **M-804EX**.

The maximum CAT 5e cable length is **100 meters**.

b. RD EXP

Daisy connection for additional remote controller (4 controllers max).

The maximum CAT 5e cable length for daisy chain **100 meters** in total from **M-8080D** RD port to last controller.



Attention:

- 1) **M-800RM / M-822IO / M-802RC** (with audio transmission) can only be connected to the RD port of the **M-8080D** or the RD EXP port 1 of **M-804EX**.
- 2) **M-800RC / M-800RCT** (with control function) can link each other.

Wall installation instructions:

1. First unscrew the screw on the bottom of the device with a screwdriver.
2. Fix the rear panel to the wall. Screw both ends to the wall. Check for firmness or crooked nails.
3. Insert the distributed network cable into the RD IN port, and snap the device to the rear panel. Tighten the bottom with screws.

The installation diagram is as follows:

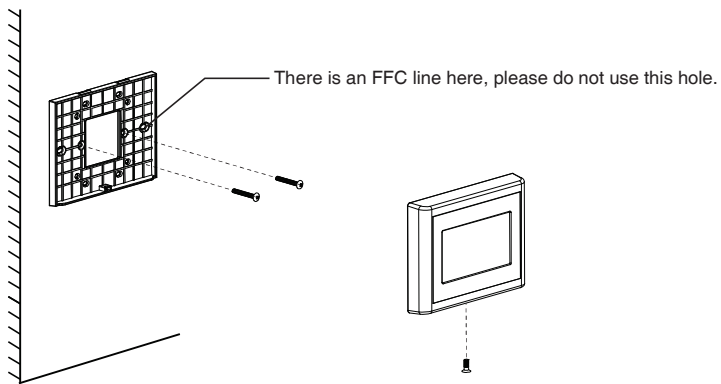

The device can set up four different sub menu pages, like **Input**, **Output**, **Preset** and **System**.

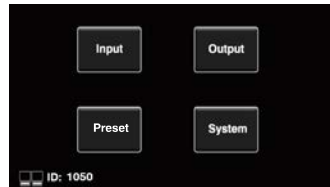

In the **Input** section, volume and mute can be adjusted and visually monitored.

- 1) CH 01 - CH 12: Select input channel 01 - 12. Adjustable input volume.
- 2) Fader: Slide the lever to adjust the input volume.
- 3) MUTE: Mute the current channel volume.
- 4) Flashing here means that the communication is normal,
- 5) UP: Page up.
- 6) DOWN: Page down.
- 7) MENU: Click this function to return to the menu bar.



In the **Output** section, the routing function can assign any input to any output. Volume and mute can be adjusted and visually monitored.

- 1) Mute: Click this button, the selected current output channel will be muted.
- 2) Output 01 - Output 12: Switch the setting interface of OUT 01 - OUT 12.
- 3) Input 01 - Input 12: Turn on / off input channels 01 - 12.
- 4) Output Volume: Push the fader to adjust the output volume.
- 5) Flashing here means normal communication.
- 6) UP: Page up.
- 7) DOWN: Page down.
- 8) MENU: Click this function to return to the menu bar.

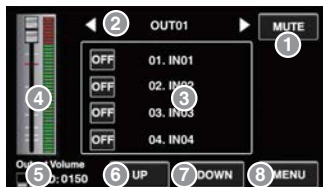

The **Preset** menu can call up setting presets memorized in the **M-8080D**.

- 1) Preset List: All the presets on the main unit are displayed here.
- 2) UP: Page up.
- 3) DOWN: Page down.
- 4) LOAD: Select a preset and click LOAD to load as current preset.
- 5) Flashing here means normal communication.
- 6) MENU: Click this function to return to the menu bar.



The **System** section displays the firmware version, address and device name. It also switches the language option.

- 1) The device name, address, firmware version, language are displayed here
- 2) Blinking here indicates normal communication.
- 3) Click LOCK to lock immediately, you need to enter the set password to unlock. The password can be set on the software. If you accidentally forget the password, you can enter 0000 to unlock.
- 4) It displays the current system language.
- 5) MENU: Click this function to return to the menu bar.



M-800RCT Editor

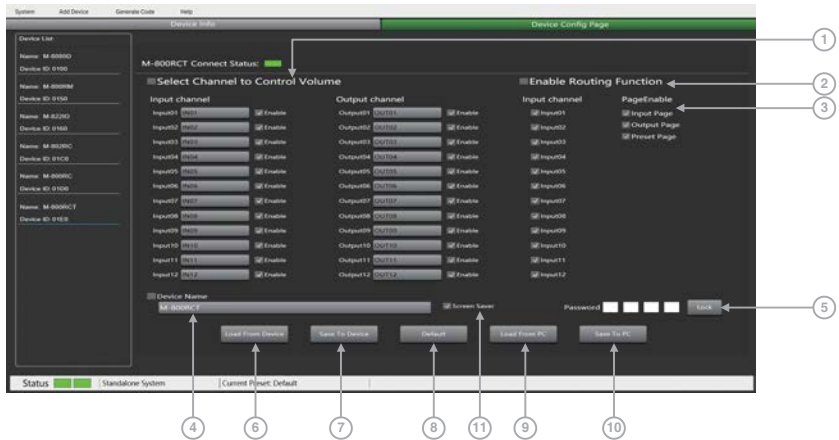

1. Select Channel to control volume:

-**Input Channel 1 - 12:** Check the box to control the input of multiple channels at once.

-**Output Channel 1 - 12:** Check the box to control the output of multiple channels at once.

2. Enable Routing Function:

-**Input Channel 1 - 12:** Check the box to control the routing of multiple output channels at once.

3. Page Enable: By default, all pages are enabled. When unchecked, this page is disabled and cannot be accessed.

-**Input page:** After unchecking this box, the display interface is disabled and the input interface cannot be entered.

-**Output page:** After unchecking this box, the display interface is disabled and the output interface cannot be entered.

-**Preset page:** After unchecking this box, the display interface is disabled and you cannot enter the preset list interface.

4. Device Name Setting: Click to customize the device name, and then click Save To Device to save successfully.

5. Lock System: The user can enter numbers and letters as password and click lock. If he forgets the password that can use factory password: 0000.

Note: After unlocking, no other password can be set. You must first lock and then unlock with 0000 to set a new lock password.

6. Load From Device: Load preset parameters from the device.

7. **Save to Device:** Save the current parameters to the device.

8. **Default:** Restore initialization parameters.

9. **Load From PC:** Load presets from local PC.

10. **Save To PC:** Save the current preset parameters to the local PC.

11. **Screen Saver:** After checking this box, the machine will sleep after one minute of inactivity.

Note: The factory setting is ON. In order to prolong the life of the LC-Display, it is recommended that the user set it to ON.

8.6. M-804EX



The **M-804EX** is a port expander featuring a star connection of the controllers. This interface is particularly useful when daisy chain between devices is not possible or when the controllers are far away from the **M-8080D**.

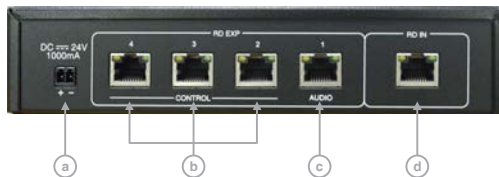

a. 24V DC power supply

When there are too many devices connected to the RD EXP port of **M-804EX** and the POWER LED on the front panel of **M-804EX** is off, please connect an DC24V external power supply. Note that the power connection polarity.

b. RD connections for **M-800RC / M-800RCT** (control data remote devices only).

c. RD connection for **M-802RC / M-822IO / M-800RM** (control and audio transport data remote devices) or **M-800RC / M-800RCT** (control data remote devices).

d. RD connection with **M-8080D**.

Note:

- Each **M-8080D** RD port can support up to 1pc **M-804EX**, cannot connect another **M-804EX** through the RD EXP port.
- Each RD EXP port can support up to 4pcs **M-800RC / M-800RCT**.
- The maximum CAT 5e cable length for daisy chain **100 meters** in total from **M-8080D** RD port to last controller.

9. APPLICATION EXAMPLES

RETAIL STORE

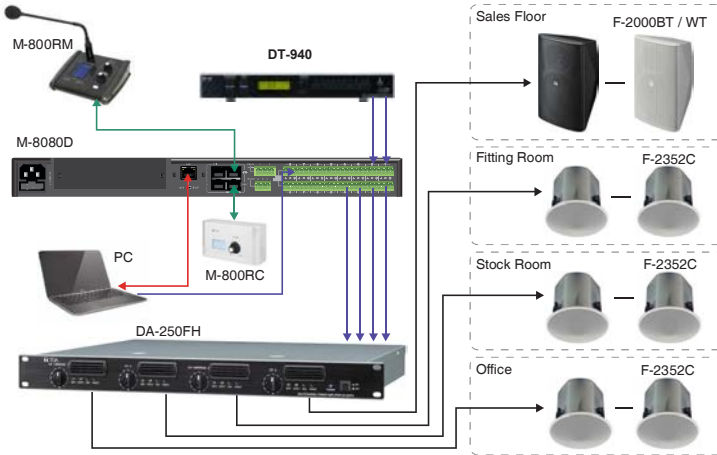

Simple installation with
ambiance control

The 4 zone volumes are
individually controlled from
the office or from the counter
with stereo or mono signals.

A free Soundcard Output of
PC can be connected to
M-8080D to broadcast
Music/Messages/
Advertisement.

The computer can be used
to edit the M-8080D as well.

GYM

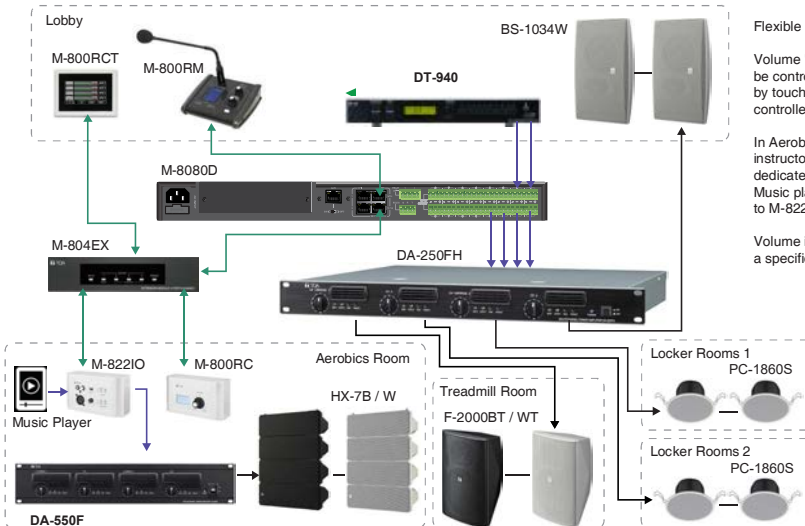

Flexible sound control

Volume "and presets" can
be controlled from the lobby
by touch panel remote
controller M-800RCT.

In Aerobics Rooms,
instructors can play
dedicated music via
Music player connected
to M-822IO input/output.

Volume is controlled with
a specific M-800RC device.

MALL

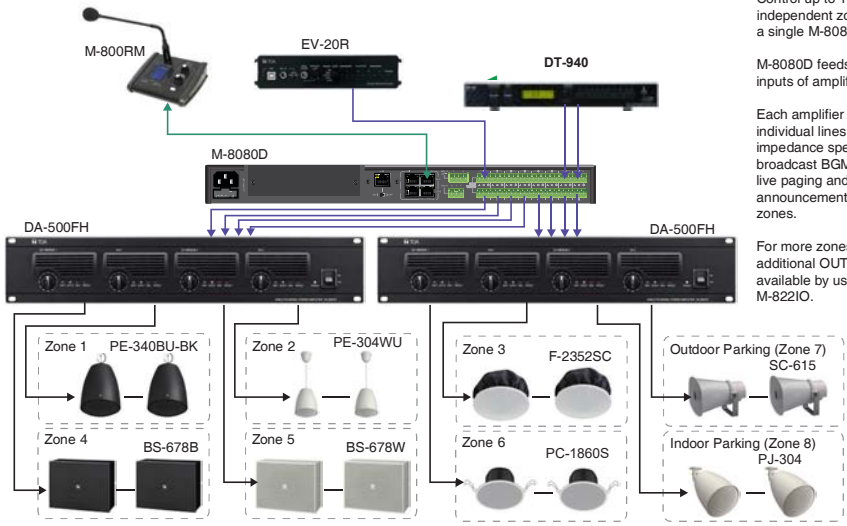

Control up to 12 independent zones with a single M-8080D

M-8080D feeds 2 x 4 analog inputs of amplifiers.

Each amplifier offers 4 individual lines of high impedance speakers to broadcast BGM program, live paging and pre-recorded announcement in separate zones.

For more zones, 2 x additional OUT are available by using a M-822IO.

HOTEL

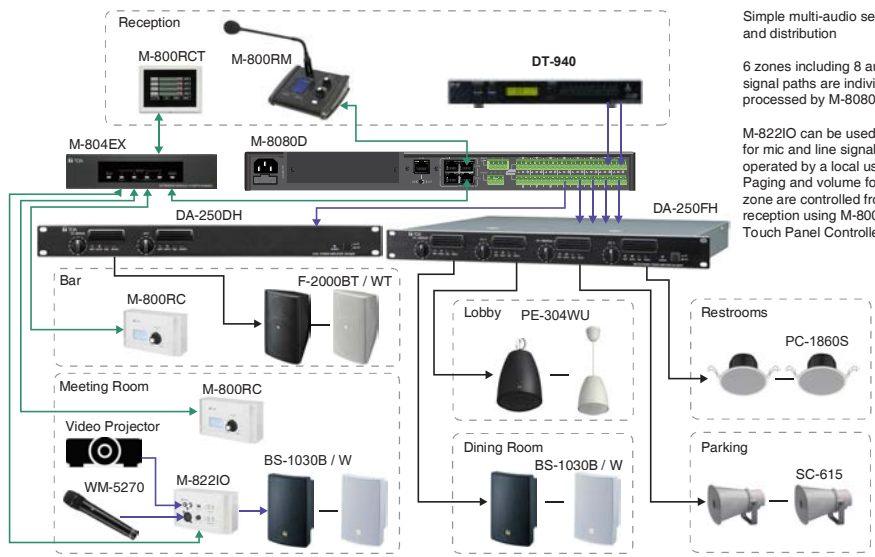

Simple multi-audio service and distribution

6 zones including 8 audio signal paths are individually processed by M-8080D.

M-822IO can be used locally for mic and line signal directly operated by a local user. Paging and volume for every zone are controlled from the reception using M-800RCT Touch Panel Controller.

RESTAURANT / BAR

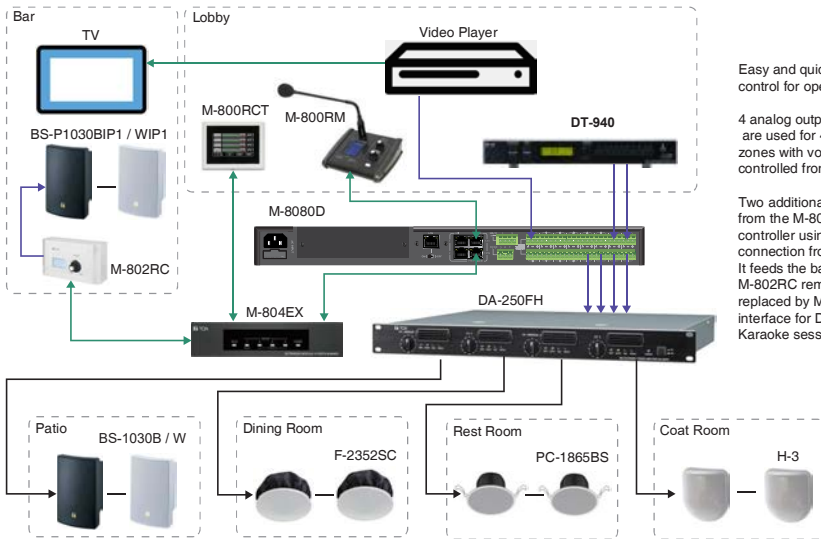

Easy and quick volume control for operators

4 analog outputs of M-8080D are used for 4 separate zones with volume controlled from the lobby.

Two additional line out come from the M-802RC remote controller using digital connection from the M-8080D. It feeds the bar area where M-802RC remote can be replaced by M-822IO In/Out interface for DJ show or Karaoke session.

SCHOOL

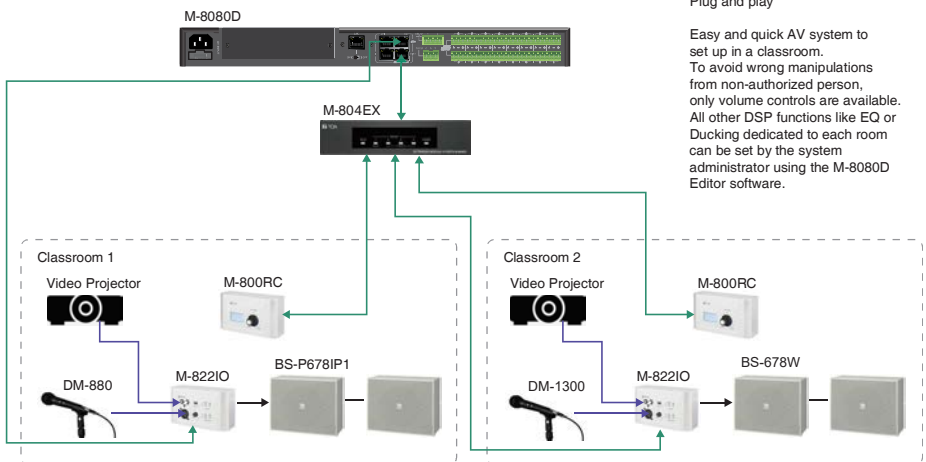

Plug and play

Easy and quick AV system to set up in a classroom. To avoid wrong manipulations from non-authorized person, only volume controls are available. All other DSP functions like EQ or Ducking dedicated to each room can be set by the system administrator using the M-8080D Editor software.

10. APPENDIX

RS232 Codes

No.	Start Byte0 (1Byte)	Start Byte1 (1Byte)	Start Byte2 (1Byte)	Length (2 byte)	Device (2Byte)	D Address (High Byte)	ID Address (Low Byte)	Type (2Byte)	Command (2Byte)	Channel Local Channel: 0x01 - 0x0C (n Byte) Network Channel: 0x0D - 0x14	Value (n Byte)	End Byte (1Byte)	Function
1	0x01	0x20	0x03	0x00 0x10	0x00 0x06	0x01 (High Byte of ID address)	0x00 (Low Byte of ID address)	0xA5 0xE8	0x00 0x01	Channel 1-12 : 0x01-0x0C (1 Byte)	Volume: 0x00-0xBE (1 Byte)	0x40	Input Gain
2	0x01	0x20	0x03	0x00 0x10	0x00 0x06	0x01 (High Byte of ID address)	0x00 (Low Byte of ID address)	0xA5 0xE8	0x00 0x02	Channel 1-12 : 0x01-0x0C (1 Byte)	Phase: 0x00-Normal, 0x01-Invert (1Byte)	0x40	Input Phase
3	0x01	0x20	0x03	0x00 0x10	0x00 0x06	0x01 (High Byte of ID address)	0x00 (Low Byte of ID address)	0xA5 0xE8	0x00 0x03	Channel 1-12 : 0x01-0x0C (1 Byte)	Mute: 0x00-Off, 0x01-On (1Byte)	0x40	Input Mute
4	0x01	0x20	0x03	0x00 0x10	0x00 0x06	0x01 (High Byte of ID address)	0x00 (Low Byte of ID address)	0xA5 0xE8	0x00 0x04	Channel 1-12 : 0x01-0x0C (1 Byte)	Invalid:0x00 (1Byte)	0x40	Get Input Status
5	0x01	0x20	0x03	0x00 0x13	0x00 0x06	0x01 (High Byte of ID address)	0x00 (Low Byte of ID address)	0xA5 0xE8	0x00 0x04	Channel 1-12 : 0x01-0x0C (1 Byte)	Volume: 0x00-0xBE (1 Byte) Phase: 0x00-Normal, 0x01-Invert (1Byte) Mute: 0x00-Off, 0x01-On (1Byte) DC48V: 0x00-Off, 0x01-On (1Byte)	0x40	Receive Input Status
6	0x01	0x20	0x03	0x00 0x10	0x00 0x06	0x01 (High Byte of ID address)	0x00 (Low Byte of ID address)	0xA5 0xE8	0x00 0x05	Channel 1-12 : 0x01-0x0C (1 Byte)	Volume: 0x00-0xBE (1 Byte)	0x40	Output Gain
7	0x01	0x20	0x03	0x00 0x10	0x00 0x06	0x01 (High Byte of ID address)	0x00 (Low Byte of ID address)	0xA5 0xE8	0x00 0x06	Channel 1-12 : 0x01-0x0C (1 Byte)	Phase: 0x00-Normal, 0x01-Invert (1Byte)	0x40	Output Phase
8	0x01	0x20	0x03	0x00 0x10	0x00 0x06	0x01 (High Byte of ID address)	0x00 (Low Byte of ID address)	0xA5 0xE8	0x00 0x07	Channel 1-12 : 0x01-0x0C (1 Byte)	Mute: 0x00-Off, 0x01-On (1Byte)	0x40	Output Mute
9	0x01	0x20	0x03	0x00 0x10	0x00 0x06	0x01 (High Byte of ID address)	0x00 (Low Byte of ID address)	0xA5 0xE8	0x00 0x08	Channel 1-12 : 0x01-0x0C (1 Byte)	Invalid:0x00 (1Byte)	0x40	Get Output Status
10	0x01	0x20	0x03	0x00 0x13	0x00 0x06	0x01 (High Byte of ID address)	0x00 (Low Byte of ID address)	0xA5 0xE8	0x00 0x08	Channel 1-12 : 0x01-0x0C (1 Byte)	Volume: 0x00-0xBE (1 Byte) Phase: 0x00-Normal, 0x01-Invert (1Byte) Mute: 0x00-Off, 0x01-On (1Byte) Invalid:0x00 (1Byte)	0x40	Receive Output Status
11	0x01	0x20	0x03	0x00 0x11	0x00 0x06	0x01 (High Byte of ID address)	0x00 (Low Byte of ID address)	0xA5 0xE8	0x00 0x09	Matrix Output Channel: 0x01-0x14 (1Byte) Matrix Input Channel: 0x01-0x14 (1Byte)	Routing: 0x00-Off, 0x01-On (1Byte)	0x40	Matrix Mixer
12	0x01	0x20	0x03	0x00 0x10	0x00 0x06	0x01 (High Byte of ID address)	0x00 (Low Byte of ID address)	0xA5 0xE8	0x00 0x0A	Matrix Output Channel: 0x01-0x14 (1Byte)	Invalid:0x00 (1Byte)	0x40	Get Matrix Mixer Status

No.	Start Byte0 (1Byte)	Start Byte1 (1Byte)	Start Byte2 (1Byte)	Length (2 byte)	Device (2Byte)	D Address (high Byte)	ID Address (Low Byte)	Type (2Byte)	Command (2Byte)	Channel Local Channel: 0x01 - 0x0C (n Byte) Network Channel: 0x0D - 0x14	Value (n Byte)	End Byte (1Byte)	Function
13	0x01	0x20	0x03	0x00 0x23	0x00 0x06	0x01 (High Byte of ID address)	0x00 (Low Byte of ID address)	0xA5 0xE8	0x00 0x0A	Matrix Output Channel: 0x01-0x14 (1Byte)	Matrix Local Input 1: 0x00-Off, 0x01-On (1Byte) Matrix Local Input 2: 0x00-Off, 0x01-On (1Byte) Matrix Local Input 3: 0x00-Off, 0x01-On (1Byte) Matrix Local Input 4: 0x00-Off, 0x01-On (1Byte) Matrix Local Input 5: 0x00-Off, 0x01-On (1Byte) Matrix Local Input 6: 0x00-Off, 0x01-On (1Byte) Matrix Local Input 7: 0x00-Off, 0x01-On (1Byte) Matrix Local Input 8: 0x00-Off, 0x01-On (1Byte) Matrix Local Input 9: 0x00-Off, 0x01-On (1Byte) Matrix Local Input 10: 0x00-Off, 0x01-On (1Byte) Matrix Local Input 11: 0x00-Off, 0x01-On (1Byte) Matrix Local Input 12: 0x00-Off, 0x01-On (1Byte) Matrix Network Input 1: 0x00-Off, 0x01-On (1Byte) Matrix Network Input 2: 0x00-Off, 0x01-On (1Byte) Matrix Network Input 3: 0x00-Off, 0x01-On (1Byte) Matrix Network Input 4: 0x00-Off, 0x01-On (1Byte) Matrix Network Input 5: 0x00-Off, 0x01-On (1Byte) Matrix Network Input 6: 0x00-Off, 0x01-On (1Byte) Matrix Network Input 7: 0x00-Off, 0x01-On (1Byte)	0x40	Receive Matrix Mixer Status
14	0x01	0x20	0x03	0x00 0x10	0x00 0x06	0x01 (High Byte of ID address)	0x00 (Low Byte of ID address)	0xA5 0xE8	0x00 0x0B	Channel 1-12 : 0x01-0x0C (1 Byte)	Invalid: 0x00 (1Byte)	0x40	Input Gain Up, Step=1dB
15	0x01	0x20	0x03	0x00 0x10	0x00 0x06	0x01 (High Byte of ID address)	0x00 (Low Byte of ID address)	0xA5 0xE8	0x00 0x0C	Channel 1-12 : 0x01-0x0C (1 Byte)	Invalid: 0x00 (1Byte)	0x40	Input Gain Down, Step=1dB
16	0x01	0x20	0x03	0x00 0x10	0x00 0x06	0x01 (High Byte of ID address)	0x00 (Low Byte of ID address)	0xA5 0xE8	0x00 0x0D	Channel 1-12 : 0x01-0x0C (1 Byte)	Invalid: 0x00 (1Byte)	0x40	Output Gain Up, Step=1dB
17	0x01	0x20	0x03	0x00 0x10	0x00 0x06	0x01 (High Byte of ID address)	0x00 (Low Byte of ID address)	0xA5 0xE8	0x00 0x0E	Channel 1-12 : 0x01-0x0C (1 Byte)	Invalid: 0x00 (1Byte)	0x40	output Gain Down, Step=1dB
18	0x01	0x20	0x03	0x00 0x10	0x00 0x06	0x01 (High Byte of ID address)	0x00 (Low Byte of ID address)	0xA5 0xE8	0x00 0x0F	Channel 1-12 : 0x01-0x0C (1 Byte)	DC-48V: 0x00-Off, 0x01-On (1Byte)	0x40	Input DC-48V
19	0x01	0x20	0x03	0x00 0x10	0x00 0x06	0x01 (High Byte of ID address)	0x00 (Low Byte of ID address)	0xA5 0xE8	0x00 0x10	Relay 1 / Relay 2: 0x01/0x02 (1Byte)	Relay Channel 1-None: 0x00-0x09	0x40	Relay Control
20	0x01	0x20	0x03	0x00 0x10	0x00 0x06	0x01 (High Byte of ID address)	0x00 (Low Byte of ID address)	0xA5 0xE8	0x00 0x11	Invalid: 0x00 (1Byte)	Invalid: 0x00 (1Byte)	0x40	Get Relay Status
21	0x01	0x20	0x03	0x00 0x10	0x00 0x06	0x01 (High Byte of ID address)	0x00 (Low Byte of ID address)	0xA5 0xE8	0x00 0x11	Relay 01 Channel 1-None: 0x00-0x09 (1Byte)	Relay 02 Channel 1-None: 0x00-0x09	0x40	Receive Relay Status
22	0x01	0x20	0x03	0x00 0x1F	0x00 0x06	0x01 (High Byte of ID address)	0x00 (Low Byte of ID address)	0xA5 0xE8	0x00 0x12	16 Chars Device Name -ASCILL Code (16Byte)	Invalid: 0x00 (1Byte)	0x40	Modify Device Name
23	0x01	0x20	0x03	0x00 0x10	0x00 0x06	0x01 (High Byte of ID address)	0x00 (Low Byte of ID address)	0xA5 0xE8	0x00 0x13	Invalid: 0x00 (1Byte)	Invalid: 0x00 (1Byte)	0x40	Get Devie Information
24	0x01	0x20	0x03	0x00 0x1F	0x00 0x06	0x01 (High Byte of ID address)	0x00 (Low Byte of ID address)	0xA5 0xE8	0x00 0x13	16 Chars Device Name -ASCILL Code (16Byte)	Firmware Version: 0x10-0x99	0x40	Receive Device Information
25	0x01	0x20	0x03	0x00 0x10	0x00 0x06	0x01 (High Byte of ID address)	0x00 (Low Byte of ID address)	0xA5 0xE8	0x00 0x14	Preset number: 0x01-0x18 (1Byte)	Invalid: 0x00 (1Byte)	0x40	Recall Preset

NOTE: RS232 Baudrate == 9600

ID address, example: If ID==0x100 then High Byte of ID address=0x01 and Low Byte of ID address=0x00

11. SPECIFICATIONS

11.1. 8x8 DIGITAL MATRIX MIXER M-8080D

Power Source	100-240 V AC, 50/60 Hz
Power Consumption	40 W
Audio Input	Input 1 - 8 : -48 to 0 dBV, 6.8 kΩ, electronic balanced, removable terminal block (3 pins x 8)
Audio Output	Output 1 - 8 : 0 dBV, 1.8 kΩ, Maximum output 20 dBu(7.75V), electronic balanced, removable terminal block (3 pins x 8)
Frequency Response	20 - 20,000 Hz, ±3 dB
Total Harmonic Distortion	0.01 %
S/N Ratio	Over 105 dB (A weighted)
Crosstalk	Over 79 dB (A weighted)
Phantom Power	+48 VDC, switchable, Inputs 1 - 8
Control input	GPI 1 - 2 : no-voltage contact input, open voltage:1.5V DC, short-circuit current: under 3 mA, RJ45 Connector x 2
Control output	Relay 1 - 2 : withstand voltage: 24V DC, control current: Under 500 mA, removable terminal block(4 pins)
RD port	RD 9 - 12 : transmits and receives AES3 digital audio plus control data connect remote devices such as M-822IO, M-800RC, M-802RC, M-800RCT and M-800RM, maximum cable length is 100 meters, RJ45 Connector x 2
Equalizer/Filter	5 band EQ (LPF and HPF) for IN and 8 band EQ (LPF and HPF) for OUT Parametric Equalizer: 19.7 - 20,160 Hz, range: ±18 dB, Q: 0.4 - 128, Type: peak/low/high Filter: High-pass Filter: 19.7 - 20,160 Hz, Type: Butterworth 6, 12, 18, 24, 30, 36, 42, 48 dB; Bessel 6, 12, 18, 24, 30, 36, 42, 48 dB; Linkwitz 12, 24, 36, 48 dB Low-pass Filter: 19.7 - 20,160 Hz, Type: Butterworth 6, 12, 18, 24, 30, 36, 42, 48 dB; Bessel 6, 12, 18, 24, 30, 36, 42, 48 dB; Linkwitz 12, 24, 36, 48 dB
Gate	Threshold: -80 to +20 dB in 1 dB steps Ratio: 1:1, 1.2:1, 1.3:1, 1.5:1, 1.7:1, 2.0:1, 2.2:1, 2.3:1, 2.5:1, 3.0:1, 3.5:1, 4.0:1, 4.5:1, 5.0:1, 5.5:1, 6.0:1, 6.5:1, 7.0:1, 7.5:1, 8.0:1, 8.5:1, 9.0:1, 9.5:1, 10.0:1, gate Attack: 10 - 150 ms Release: 10 ms - 1 s
Compressor	Threshold: -30 to +20 dB in 1 dB steps Ratio: 1:1, 1.2:1, 1.3:1, 1.5:1, 1.7:1, 2.0:1, 2.2:1, 2.3:1, 2.5:1, 3.0:1, 3.5:1, 4.0:1, 4.5:1, 5.0:1, 5.5:1, 6.0:1, 6.5:1, 7.0:1, 7.5:1, 8.0:1, 8.5:1, 9.0:1, 9.5:1, 10.0:1, limit Attack: 10 - 150 ms Release: 10 ms - 1 s
Ducker	Level: 0-15 Threshold: -80 to 0 dB in 1 dB steps Depth: -60 to 0 dB in 1 dB steps Activation: 10 ms - 6 s
Feedback compression (FBC)	Mode: Speech / Music Filter release: fast / mid / low FBC type: dynamic Filters / static Filters
Auto mixer	Activation: 10 ms - 6 s
Delay	Delay time: 0 - 1361.2916 ms
A/D Converter	24 bit
Sampling Frequency	48 kHz
Display	LC-Display Displays device information: name, firmware version, ID, communication status
Indicators	Input: Analog Signal(Green)x8, Analog Peak(Red)x8, RD Signal(Green)x4, RD Peak(Red)x4 Output: Analog Signal(Green)x8, Analog Peak(Red)x8, RD Signal(Green)x4, RD Peak(Red)x4 Status: Fault(Red)x1, Comm(Green)x1, Power(Blue)x1
Operating Temperature	0 °C to +40 °C (32 °F to 104 °F)
Operating Humidity	90 % RH or less (no condensation)
Finish	Panel: Aluminum, black Case: Surface-treated steel plate, black, paint
Dimensions	483 (W) x 44.2 (H) x 259 (D) mm (19.02" x 1.74" x 10.18")
Weight	4.58 kg
Accessory	Power cord (2 m)...2, CAT5 cable (2 m)...1, Removable terminal block(4 pins)...1, Removable terminal block(3 pins)...17
Option	M-804EX, M-822IO, M-800RC, M-802RC, M-800RCT, M-800RM

11.2. REMOTE MICROPHONE M-800RM

Power Source	24V DC (Powered by M-8080D or M-804EX)
Audio Output	0 dBV, electronic balanced, RJ45 Connector
Gooseneck Microphone	Unidirectional electret condenser microphone
Frequency Response	20 - 20,000 Hz, ± 3 dB
Total Harmonic Distortion	0.01 %
RD port	Transmits and receives AES3 digital audio plus control data Connect to M-8080D or M-804EX, RJ45 Connector
USB port	Load WAV / MP3 files for chimes sound
Volume Control	Microphone volume control and all zone selector
Zone selector	Can address 1 to 64 different zones
Display	LC-display Displays device information: ID, volume, zone selector
Indicators	Input Signal (Green) x 1, Input Peak (Red) x 1, Busy (Red) x 1, Comm (Green) x 1
Operating Temperature	0°C to +40°C (32°F to 104°F)
Operating Humidity	90% RH or less (no condensation)
Finish	Case: Surface-treated steel plate, black, paint
Dimensions	176 (W) x 61.8 (H) x 162.4 (D) mm (6.93" x 2.43" x 6.40") (gooseneck microphone excluded)
Weight	0.8 kg

11.3. REMOTE AUDIO CONTROL PANEL M-800RC

Model no.	M-800RC	M-800RCB
Power Source	24V DC (Powered by M-8080D or M-804EX)	
RD IN	Transmits and receives AES3 digital audio plus control data Connect to M-8080D, M-804EX or M-800RC, M-800RCT for daisy chain, RJ45 Connector	
RD EXP	Transmits and receives control data Connect to M-800RC or M-800RCT, RJ45 Connector	
Control	Volume / routing	
Display	LC-Display Displays device information : ID, Volume, communication status	
Operating Temperature	0°C to +40°C (32°F to 104°F)	
Operating Humidity	90% RH or less (no condensation)	
Finish	Panel: Polycarbonate + ABS, white (RAL9016 or equivalent)	Panel: Polycarbonate + ABS, black
Dimensions	147 (W) x 86 (H) x 65 (D) mm (5.79" x 3.39" x 2.56")	
Weight	0.3 kg	
Accessory	Front cover...1, Wall mounting screw (4 x 30)...4, Box mounting screw (4 x 20)...4, Plastic anchor...4	

11.4. REMOTE AUDIO CONTROL PANEL WITH AUDIO OUT M-802RC

Model no.	M-802RC	M-802RCB
Power Source	24V DC (Powered by M-8080D or M-804EX)	
Audio Output	Line output 1 - 2 : 0 dBV, 1.8 kΩ, Maximum output 20 dBu (7.75 V) , electronic balanced, screw terminal (3 pins x 2)	
RD IN	Transmits and receives AES3 digital audio plus control data Connect to M-8080D or M-804EX, RJ45 connector	
Frequency Response	20 - 20,000 Hz, ±3 dB	
Total Harmonic Distortion	0.01 %	
S/N Ratio	Over 105 dB (A weighted)	
Crosstalk	Over 79 dB (A weighted)	
Control	Volume / routing	
Display	LC-Display Displays device information : ID, Volume, communication status	
Operating Temperature	0 °C to +40 °C (32 °F to 104 °F)	
Operating Humidity	90% RH or less (no condensation)	
Finish	Panel: Polycarbonate + ABS, white (RAL9016 or equivalent)	Panel: Polycarbonate + ABS, black
Dimensions	147 (W) x 86 (H) x 65 (D) mm (5.79" x 3.39" x 2.56")	
Weight	0.3 kg	
Accessory	Front cover...1, Wall mounting screw (4 x 30)...4, Box mounting screw (4 x 20)...4, Plastic anchor...4	

11.5. REMOTE AUDIO INPUT OUTPUT PANEL M-822IO

Model no.	M-822IO	M-822IOB
Power Source	24V DC (Powered by M-8080D or M-804EX)	
Audio Input	MIC input : -48 dBV, 5.1 kΩ, electronic balanced, XLR connector Line input A - B : 0 dBV, 5.1 kΩ, unbalanced, RCA pin jack	
Audio Output	Line output 1 - 2 : 0 dBV, 1.8 k , maximum output 20 dBu (7.75 V) , electronic balanced, screw terminal (3 pins x 2)	
Frequency Response	20 - 20,000 Hz, ±3 dB	
Total Harmonic Distortion	0.01 %	
S/N Ratio	Over 105 dB (A weighted)	
Crosstalk	Over 79 dB (A weighted)	
Phantom Power	+48 VDC, switchable, MIC input	
RD IN	Transmits and receives AES3 digital audio plus control data connect to M-8080D or M-804EX, RJ45 connector	
A/D Converter	24 bit	
Sampling Frequency	48 kHz	
Indicators	Input: Signal (Green) x 2, Peak (Red) x 2 Output: Signal (Green) x 2, Peak (Red) x 2	
Operating Temperature	0 °C to +40 °C (32 °F to 104 °F)	
Operating Humidity	90 % RH or less (no condensation)	
Finish	Panel: Polycarbonate + ABS, white (RAL9016 or equivalent)	Panel: Polycarbonate + ABS, black
Dimensions	147 (W) x 86 (H) x 52 (D) mm (5.79" x 3.39" x 2.05")	
Weight	0.3 kg	
Accessory	Front cover...1, Wall mounting screw (4 x 30)...4, Box mounting screw (4 x 20)...4, Plastic anchor...4	

11.6. REMOTE AUDIO CONTROL PANEL WITH TOUCH DISPLAY M-800RCT

Model no.	M-800RCT	M-800RCTB
Power Source	24V DC (Powered by M-8080D or M-804EX)	
RD IN	Transmits and receives AES3 digital audio plus control data Connect to M-8080D, M-804EX or M-800RC, M-800RCT for daisy chain, RJ45 Connector	
RD EXP	Transmits and receives control data Connect to M-800RC or M-800RCT, RJ45 Connector	
Display	LC-Display Displays device information : ID, Volume, preset, communication status, system, etc.	
Operating Temperature	0° C to +40 °C (32 °F to 104 °F)	
Operating Humidity	90% RH or less (no condensation)	
Finish	Panel: Polycarbonate + ABS, white (RAL9016 or equivalent)	Panel: Polycarbonate + ABS, black
Dimensions	150 (W) x 115 (H) x 28 (D) mm (5.90" x 4.53" x 1.10")	
Weight	0.28 kg	
Accessory	Wall mounting screw (4 x 30)...4, Box mounting screw (4 x 20)...4, Plastic anchor...4	

11.7. EXTENSION MODULE 4 PORTS M-804EX

Power Source	24V DC (Powered by M-8080D or DC24V external power supply)
RD IN	Transmits and receives AES3 digital audio plus control data Connect to M-8080D, RJ45 Connector
RD EXP	Port 1: transmits and receives AES3 digital audio plus control data connect to M-822IO, M-800RC, M-802RC, M-800RCT or M-800RM, RJ45 Connector maximum cable length 100 meters in total from M-8080D RD port to last controller Port 2-4: transmits and receives control data connect to M-800RC or M-800RCT, RJ45 Connector maximum cable length 100 meters in total from M-8080D RD port to last controller
Indicators	RD in(Green) x 1, RD exp audio(Green) x 1, RD exp control(Green) x 3, Power(Red) x 1
Operating Temperature	0 °C to +40 °C (32 °F to 104 °F)
Operating Humidity	90 % RH or less (no condensation)
Finish	Panel: Aluminum, black Case: Surface-treated steel plate, black, paint
Dimensions	196.2 (W) x 44.2 (H) x 133 (D) mm (7.72" x 1.74" x 5.24")
Weight	0.92 kg
Accessory	Removable terminal plug(2p)...1, CAT.5e cable(2m)...1, Plastic foot pad...4

EMC PRECAUTIONS

Warning: Operation of this equipment in a residential environment could cause radio interference.

Note: This equipment has been tested and found to comply with the limits for a Class B digital device, pursuant to part 15 of the FCC Rules. These limits are designed to provide reasonable protection against harmful interference in a residential installation. This equipment generates, uses and can radiate radio frequency energy and, if not installed and used in accordance with the instructions, may cause harmful interference to radio communications. However, there is no guarantee that interference will not occur in a particular installation.

If this equipment does cause harmful interference to radio or television reception, which can be determined by turning the equipment off and on, the user is encouraged to try correct the interference by one or more of the following measures:

- Reorient or relocate the receiving antenna.
- Increase the separation between the equipment and receiver
- Connect the equipment into an outlet on a circuit different from that to which the receiver is connected.
- Consult the dealer to an experienced radio/TV technician for help.

Manufacturer:
TOA Corporation
7-2-1, Minatojima-Nakamachi, Chuo-ku, Kobe, Hyogo, Japan

Traceability Information for Europe

Authorized representative:
TOA Electronics Europe GmbH
Suederstrasse 282, 20537 Hamburg,
Germany

Traceability Information for Americas

Authorized representative:
TOA Electronics, Inc.
1 Harmon Plaza, Suite 700 Secaucus,
New Jersey 07094, USA
TEL: +1 650 452 1200