

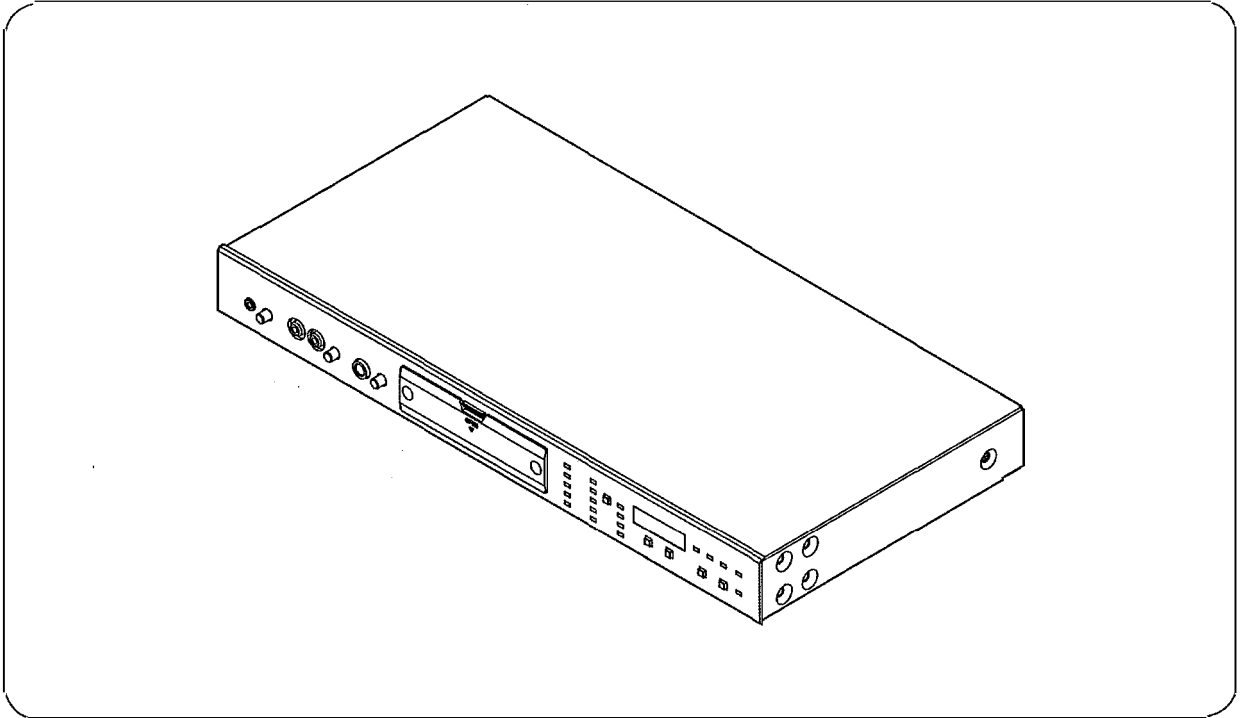

INSTRUCTION MANUAL

**DIGITAL ANNOUNCER**

**EV-700**



Thank you for purchasing TOA's Digital Announcer.  
Please carefully follow the instructions in this manual to ensure long, trouble-free use of your equipment.

**TOA Canada Corporation**

# TABLE OF CONTENTS

<b>1. IMPORTANT SAFETY INSTRUCTIONS</b> .....	5
<b>2. SAFETY PRECAUTIONS</b> .....	6
<b>3. GENERAL DESCRIPTION</b> .....	8
<b>4. FEATURES</b> .....	8
<b>5. HANDLING PRECAUTIONS</b> .....	8

## ***BASIC USAGE***

<b>6. HANDLING OF MEMORY CARD</b> .....	9
6.1. Usable Memory Card .....	9
6.2. Memory Card Handling Precautions .....	9
6.3. Memory Card Removal and Insertion .....	9
<b>7. NOMENCLATURE AND FUNCTIONS</b> .....	10
Front .....	10
Rear .....	12
<b>8. WORKFLOW</b> .....	13
<b>9. TRY TO USE FIRST</b> .....	14
9.1. Connections .....	14
9.2. Broadcasting (Playing) .....	15
<b>10. PHRASE AND PROGRAM</b> .....	16
10.1. What is phrase? .....	16
10.2. What is Program? .....	16
10.3. Playing a Program .....	17
10.4. Factory-Preset Program .....	18
<b>11. OPERATION</b> .....	19
11.1. Playing a Program .....	19
11.2. Stopping Program Playback .....	21
11.3. Recording to Phrase .....	22
11.4. Deleting Phrase .....	25
11.5. Confirming the Recorded Contents on Memory Card .....	27
11.6. Disabling Each Key Operation on the Front Panel (Lock Mode) .....	27
<b>12. ACTIVATING OPERATION BY WAY OF EXTERNAL CONTROL</b> .....	28
12.1. Setting the Control Method .....	28
12.2. Inputting Control Signals .....	28
12.3. Details of the Setting Items .....	30
12.4. Details of the Activation Signals and Operations .....	38
<b>13. TYPES OF EMERGENCY BROADCASTS</b> .....	51

<b>14. EMERGENCY PLAYBACK (FRONT KEY OPERATION)</b>	52
14.1. Recording Audio Sources	52
14.2. Making Emergency Playback	55
14.3. Stopping Emergency Playback	57
14.4. Confirming Audio Source Contents	58
14.5. Deleting the Recorded Audio Sources	59
<b>15. EMERGENCY PLAYBACK (USING THE CONTROL INPUT TERMINALS)</b>	61
15.1. Making Emergency Playback	61
15.2. Stopping Emergency Playback	62
<b>16. R.E.M. PLAYBACK</b>	63
16.1. Repetitive Operation of R.E.M. Playback	63
16.2. Operation and Setting at the Time of Emergency Broadcast	65

<b>DETAILED USAGE</b>
-----------------------

<b>17. PLAYBACK SYSTEMS</b>	66
<b>18. MAINTENANCE FUNCTION</b>	71
18.1. Performing All-program Playback (Use Switch 1.)	72
18.2. Adjusting the Whole Sound Volume (Use Switch 1.)	73
18.3. Playing, Recording, or Deleting Emergency Playback Audio Source (Use Switch 2.)	73
18.4. Uploading/Downloading Unit Setting File (Use Switch 3.)	74
18.5. Returning the Network Setting to the Default Value Temporarily (Use Switch 3.)	75
18.6. Copying the Memory Card (Use Switch 4.)	75
18.7. Updating the Firmware (Use Switches 5 and 8.)	76
18.8. Initializing the Unit Settings (Use Switches 6 and 8.)	77
<b>19. CONFIRMING THE FIRMWARE VERSION</b>	78
<b>20. ACQUIRING OPERATION LOG</b>	79
<b>21. PRIORITY LEVEL SETTINGS</b>	80
<b>22. EXTERNAL INPUT BROADCAST</b>	81
22.1. Outline	81
22.2. Broadcast Priority Level	81
22.3. Making External Input Broadcast	82
<b>23. BROADCAST SOUND VOLUME</b>	84
23.1. Sound Volume of Normal Broadcast and Emergency Broadcast	84
23.2. Sound Volume of the Microphone Broadcast and the Line Input Broadcast	85
<b>24. DELAY TIME</b>	85
<b>25. CONTROL OUTPUT (BUSY SIGNAL)</b>	85
25.1. What is Busy Signal?	85
25.2. Setting a Busy Signal	86

<b>26. ERROR OUTPUT</b> .....	87
<b>27. BACKUP FUNCTION</b> .....	88
27.1. Enabling the Backup function .....	88
27.2. Operation of the Unit When the Backup Function Is Enabled .....	89
27.3. Returning the Operation Using the Memory card B to That Using the Memory card A .....	89

## **INSTALLATION AND CONNECTIONS**

<b>28. INSTALLATION</b> .....	90
28.1. Mounting the Unit in an Equipment Rack .....	90
28.2. Installing the Unit on the Desk .....	90
<b>29. CONNECTIONS</b> .....	91
29.1. Front Panel Connections .....	91
29.2. Rear Panel Connections .....	92
29.3. Removable Terminal Plug Connection .....	94

## **REFERENCE**

<b>30. IF YOU HAVE ANY PROBLEMS</b> .....	95
30.1. Troubleshooting .....	95
30.2. Error List .....	98
<b>31. ABOUT THE EV-700'S STATE AND INPUT/OUTPUT</b> .....	101
<b>32. PRERECORDED AUDIO FILE LIST</b> .....	102
<b>33. SPECIFICATIONS</b> .....	103
Accessories .....	104
Optional products .....	104

# 1. IMPORTANT SAFETY INSTRUCTIONS

- Read these instructions.
- Keep these instructions.
- Heed all warnings.
- Follow all instructions.
- Do not use this apparatus near water.
- Clean only with dry cloth.
- Do not install near any heat sources such as radiators, heat registers, stoves, or other apparatus (including amplifiers) that produce heat.
- Do not defeat the safety purpose of the polarized or grounding-type plug.  
A polarized plug has two blades with one wider than the other. A grounding type plug has two blades and a third grounding prong. The wide blade or the third prong are provided for your safety.  
If the provided plug does not fit into your outlet, consult an electrician for replacement of the obsolete outlet.
- Protect the power cord from being walked on or pinched particularly at plugs, convenience receptacles, and the point where they exit from the apparatus.
- Only use attachments/accessories specified by the manufacturer.
- Use only with the cart, stand, tripod, bracket, or table specified by the manufacturer, or sold with the apparatus. When a cart is used, use caution when moving the cart/ apparatus combination to avoid injury from tip-over.
- Unplug this apparatus during lightning storms or when unused for long periods of time.
- Refer all servicing to qualified service personnel. Servicing is required when the apparatus has been damaged in any way, such as power-supply cord or plug is damaged, liquid has been spilled or objects have fallen into the apparatus, the apparatus has been exposed to rain or moisture, does not operate normally, or has been dropped.



## 2. SAFETY PRECAUTIONS

- Before installation or use, be sure to carefully read all the instructions in this section for correct and safe operation.
- Be sure to follow all the precautionary instructions in this section, which contain important warnings and/or cautions regarding safety.
- After reading, keep this manual handy for future reference.

### Safety Symbol and Message Conventions

Safety symbols and messages described below are used in this manual to prevent bodily injury and property damage which could result from mishandling. Before operating your product, read this manual first and understand the safety symbols and messages so you are thoroughly aware of the potential safety hazards.



### **WARNING**

Indicates a potentially hazardous situation which, if mishandled, could result in death or serious personal injury.



### **CAUTION**

Indicates a potentially hazardous situation which, if mishandled, could result in moderate or minor personal injury, and/or property damage.



### **WARNING**

#### When Installing the Unit

- Do not expose the unit to rain or an environment where it may be splashed by water or other liquids, as doing so may result in fire or electric shock.
- Use the unit only with the voltage specified on the unit. Using a voltage higher than that which is specified may result in fire or electric shock.
- Do not cut, kink, otherwise damage nor modify the power supply cord. In addition, avoid using the power cord in close proximity to heaters, and never place heavy objects -- including the unit itself -- on the power cord, as doing so may result in fire or electric shock.
- Avoid installing or mounting the unit in unstable locations, such as on a rickety table or a slanted surface. Doing so may result in the unit falling down and causing personal injury and/or property damage.
- Since the unit is designed for indoor use, do not install it outdoors. If used outdoors, there is a danger of electric shock when it gets wet with rain.
- Use the specified rack mounting bracket in combination.  
Doing otherwise may cause the unit to fall off, resulting in personal injury.

#### When the Unit is in Use

- Should the following irregularity be found during use, immediately stop the power supply to the unit and contact your nearest TOA dealer. Make no

further attempt to operate the unit in this condition as this may cause fire or electric shock.

- If you detect smoke or a strange smell coming from the unit.
- If water or any metallic object gets into the unit
- If the unit falls, or the unit case breaks
- If the power supply cord is damaged (exposure of the core, disconnection, etc.)
- If it is malfunctioning (no tone sounds.)
- To prevent a fire or electric shock, never open nor remove the unit case as there are high voltage components inside the unit. Refer all servicing to qualified service personnel.
- Do not place cups, bowls, or other containers of liquid or metallic objects on top of the unit. If they accidentally spill into the unit, this may cause a fire or electric shock.
- Do not insert nor drop metallic objects or flammable materials in the CF card slots on the unit's front panel, as this may result in fire or electric shock.
- (When the AC adapter is used)  
Do not touch the AC adapter's power plug during thunder and lightning, as this may result in electric shock.



### **CAUTION**

#### When Installing the Unit

- (When the AC adapter is used)  
Never plug in nor remove the AC adapter's power plug with wet hands, as doing so may cause electric shock.

- (When the AC adapter is used)

When unplugging the AC adapter's power plug, be sure to grasp the power plug; never pull on the cord itself. Operating the unit with a damaged power supply cord may cause a fire or electric shock.

- (When the AC adapter is used)

When moving the unit, be sure to remove the AC adapter's power plug from the wall outlet. Moving the unit with the power cord connected to the outlet may cause damage to the power cord, resulting in fire or electric shock. When removing the power cord, be sure to hold its plug to pull.

- Avoid installing the unit in humid or dusty locations, in locations exposed to the direct sunlight, near the heaters, or in locations generating sooty smoke or steam as doing otherwise may result in fire or electric shock.

- Be sure to follow the instructions below when rack-mounting the unit. Failure to do so may cause a fire or personal injury.

- Install the equipment rack on a stable, hard floor. Fix it with anchor bolts or take other arrangements to prevent it from falling down.

- When connecting the unit's power cord to an AC outlet, use the AC outlet with current capacity allowable to the unit.

- The supplied rack-mounting screws can be used for the TOA equipment rack only. Do not use them for other racks.

## When the Unit is in Use

- Make sure that the volume control is set to minimum position before power is switched on. Loud noise produced at high volume when power is switched on can impair hearing.

- Do not operate the unit for an extended period of time with the sound distorting. Doing so may cause the connected speakers to heat, resulting in a fire.

- (When the AC adapter is used)

Use the specified AC adapter for the unit. Note that the use of other adapter may cause a fire.

- (When the AC adapter is used)

If dust accumulates on the AC adapter's power plug or in the wall AC outlet, a fire may result. Clean it periodically. In addition, insert the plug in the wall outlet securely.

- Disconnect the power cord from the unit for safety purposes when cleaning or leaving the unit unused for 10 days or more. Doing otherwise may cause a fire or electric shock.

### 3. GENERAL DESCRIPTION

The EV-700 is a digital announcing machine capable of recording and playing sound. It plays the recorded contents made by connecting a microphone or player to the EV-700 and the sound source data prepared separately.

It is ideal for periodical, attention calling, and guide broadcast uses in commercial and public facilities.

Other feature includes the dedicated EV-700 Setting software program\*<sup>1</sup> that performs settings and the data transfer of audio files.

\*<sup>1</sup> Recorded on the supplied CD.

### 4. FEATURES

- Settings and control of the EV-700, and sound source rewriting via the network connection to a PC.
- Simple operation for recording and repeat play in case of an emergency situation.
- Quick start of chime broadcast using Prerecorded audio files\*<sup>2</sup> contained in the supplied memory card.
- Another memory card automatically takes over broadcast operation without interruption even if the memory card in use fails.
- Plays recorded phrases combined as a program.
- User assignable priority level to the programs.

\*<sup>2</sup> Audio files written to the memory card supplied with the unit.

### 5. HANDLING PRECAUTIONS

- **Warning:** This is a class A product. In a domestic environment this product may cause radio interference in which case the user may be required to take adequate measures.
- Make a backup copy of the prerecorded audio files before using them. To make a copy, use the unit's copy function (See p. 75.) or a PC. Prerecorded audio files cannot be restored once deleted. Redistribution is fee-based.
- Before using the EV-700 unit, insert a usable memory card into it. (See p. 9.) Otherwise, the EV-700 unit cannot be used.
- Keep the EV-700 and AC adapter (optional) as far as possible from the devices such as radio and wireless tuner. Failure to do so may cause radio interference.
- Duplication or diversion of commercially available music and sound source data is prohibited by law without permission of the right holder except when exempted from the Copyright Act.  
We recommend that you will consult an expert on Copyright when using such music or data.
- Prerecorded audio files on the supplied memory card can only be used with the EV-700. Never use them with other products.
- When cleaning the unit, be sure to turn the power switch to OFF. Wipe with a soft dry cloth. If it gets very dirty, use the soft cloth slightly moistened in neutral cleanser. Never use thinner, benzene, chemically processed towels, or alcohol as the unit's plastic or other parts may be deformed or discolored.
- TOA Corporation accepts no responsibility for the data lost or damaged.



## 6. HANDLING OF MEMORY CARD

### 6.1. Usable Memory Card

Only the supplied memory card can be used for the unit. When optional cards are needed, purchase them from your nearest TOA dealer.

We cannot guarantee the operation if other cards are used.

- The maximum recordable time is about 3 hours when a sampling frequency of audio sources is 44.1 kHz and about 4 hours when it is 32 kHz.
- A memory card for the EV-350P or EV-350R cannot be used.
- The memory card format is FAT16 and FAT32.

### 6.2. Memory Card Handling Precautions

- Do not use the supplied memory card for equipment other than the EV-700, as this could lead to data damage or loss.
- Never touch the terminal pins on the memory card, as this could lead to data damage or loss from static electricity.
- Ensure no foreign objects such as dust or dirt get into the connector section to prevent poor contact.
- Do not store the unit in the following locations.
  - Locations exposed to both high temperatures and high humidity
  - Locations with a large temperature difference
  - Locations with dust and dirt
  - Locations where a shock or vibration is given
- Never give the unit a shock or vibration nor remove the card from the card slot during data writing or reading, as this could lead to data damage or loss.

### 6.3. Memory Card Removal and Insertion

Detach the front cover, then insert or remove the memory card.

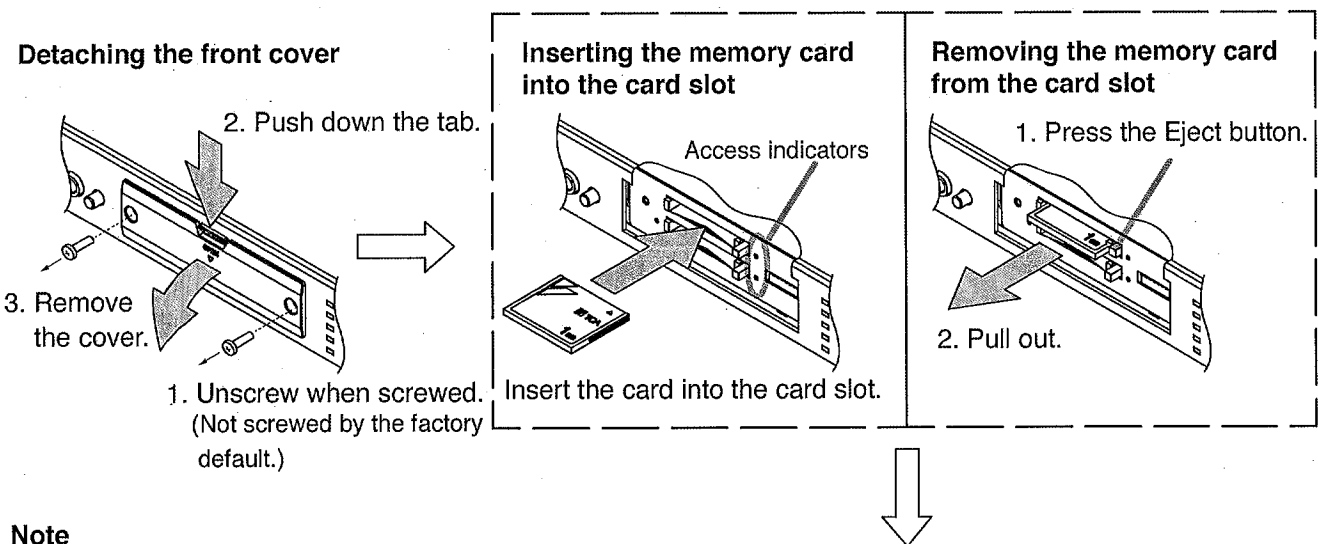

#### Note

The unit has 2 memory card slots. Do not remove each card from or insert it into the slot while either or both Access indicators are lighting or flashing. Data on the card may be lost.

**Replace the front cover.**  
(Fix it with the supplied machine screws M3 x 12 as needed.)

# 7. NOMENCLATURE AND FUNCTIONS

[Front]

[Inside the Front cover (9)]

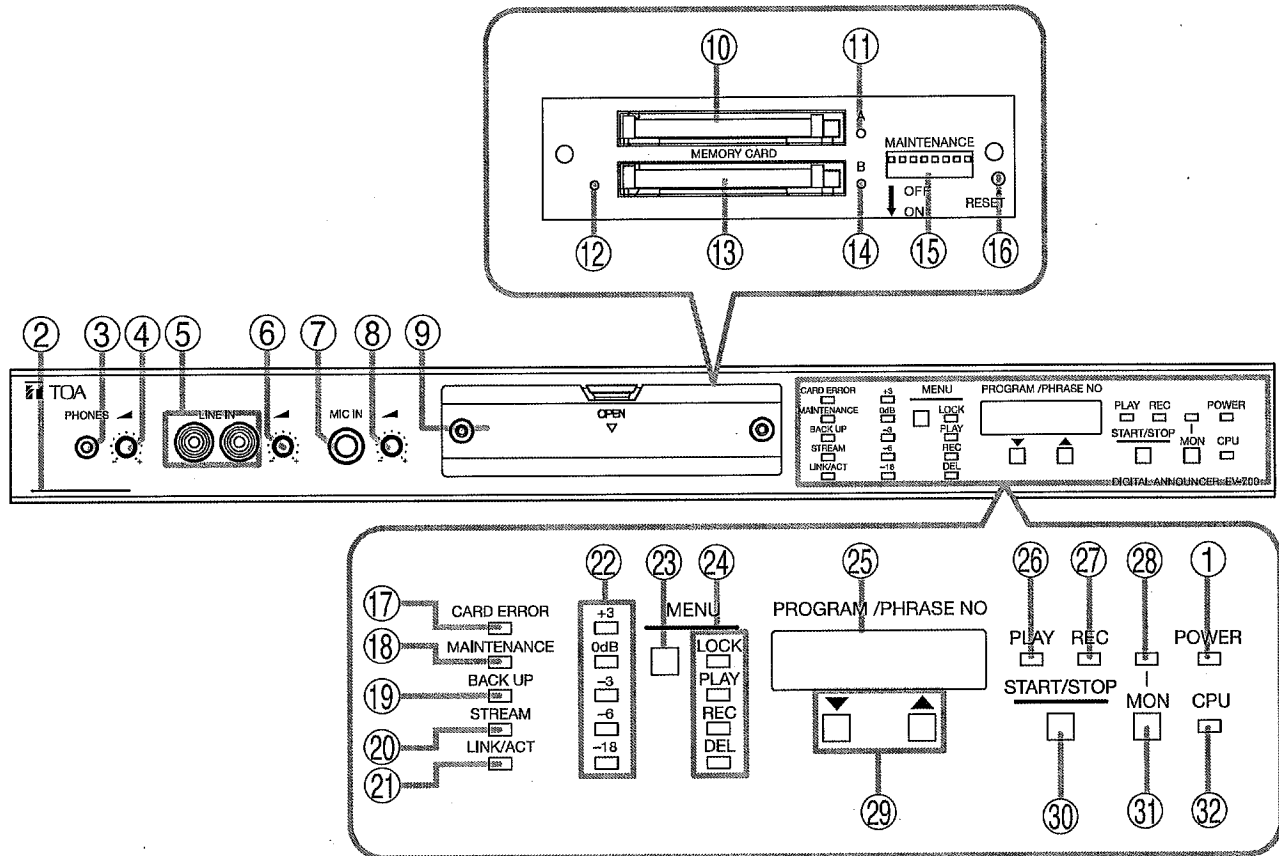

**1. Power indicator (Green)**

Lights when the power is supplied to the unit.

**2. MAC address**

Indicates the unit's MAC address\*1.

\*1 A 12-digit hexadecimal address inherently assigned to and unique to a networking device.

**3. Headphone output jack**

0 dB\*2, 100 Ω, monaural, 3.5 mm mini jack (3P)  
Connect headphones to this terminal.

**4. Headphone output volume control**

Adjusts the sound volume of the Headphone output jack (3).

**5. Line input jack**

-20 dB\*2, 10 kΩ, RCA jack  
Connect an external player for recording and broadcast to this terminal.

**Note**

Stereo input signals, if entered, are converted into monaural signals after stereo left and right channel signals are internally mixed.

Signals entered to this terminal and those entered to the rear-mounted Line input terminals (40) are internally mixed.

**6. Line input volume control**

Adjusts the sound volume of both the Line input jack (5) and the Line input terminals of the rear-mounted Input/Output terminals (40).

**7. Microphone input jack**

-55 dB\*2, 600 Ω, unbalanced, 6.3 mm phone jack (2P)

Connect a microphone for recording or announcement use to this jack.

**Note**

Phantom power is not supplied from this input.

**8. Microphone input volume control**

Adjusts the sound volume of the Microphone input jack (7).

**9. Front cover**

A cover for preventing accidental wrong operation.

**Tip**

Not screwed by the factory default.

Secure both sides of the cover with the machine screws M3 x 12 as needed.

**10. Memory card slot A**

Insert a memory card (hereinafter referred to as Memory card A) in this slot.

(See p. 102, "PRERECORDED AUDIO FILE LIST.")

**11. Memory card slot A access indicator (Green)**

Lights or flashes while writing a file to or reading a file from the Memory card A.

\*2 0 dB = 1 V

**12. Memory card B in-use indicator (Green)**  
Flashes during operation using the Memory card slot B's memory card (hereinafter referred to as Memory card B).

**13. Memory card slot B**  
Insert the Memory card B in this slot.

**14. Memory card slot B access indicator (Green)**  
Lights or flashes while writing a file to or reading a file from the Memory card B.

**15. DIP switch for maintenance**  
Used when conducting maintenance.  
For settable functions, see p. 71, "MAINTENANCE FUNCTION."

**Note**  
Setting any one of the switches to the ON position places the unit in maintenance mode, disabling broadcasts made by the contact control or using the EV-700 Setting software.  
Be sure to set all the switches to the OFF positions after completing maintenance.

**16. Reset switch**  
Reboots the unit when held down for 2 seconds or more.

**Note**  
Do not reset the unit while the Memory card slot A access indicator (11) or Memory card slot B access indicator (14) is lighting or flashing.

**17. Card error indicator (Red)**  
Lights if any card error occurs.

**18. Maintenance indicator (Orange)**  
Flashes while in Maintenance mode.  
(See p. 71, "MAINTENANCE FUNCTION.")

**19. Backup indicator (Green)**  
Lights when the backup function is enabled.  
(See p. 88, "BACKUP FUNCTION.")

**20. Streaming indicator**  
Not used.

**21. LINK/ACT indicator (Green)**  
Lights when the unit is connected to a network and flashes during data transmission or reception.  
**Tip**  
Lights or flashes synchronously with the LINK/ACT indicator of the rear-mounted LAN terminal (33).

**22. Level meter**  
Indicates the audio output level during broadcast or the audio input level during recording.

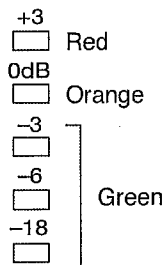

**23. Menu key**  
Selects mode.

**24. Mode indicator**  
Indicates the current operation mode (Lock mode, Play mode, Recording mode, or Delete mode).

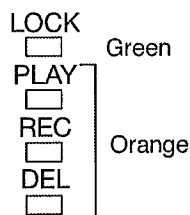

**25. Status display**  
Displays Program number, Phrase number, setting content, or error information.

**26. Play indicator (Green)**  
Lights during playback.

**27. Recording indicator (Red)**  
Flashes during recording standby status or lights during recording.

**28. Monitor indicator (Orange)**  
Lights during monitor.

**29. Up and Down keys**  
Selects Program number, Phrase number, or Setting value.

**30. Start/Stop key**  
Starts or stops the function according to each mode.

**31. Monitor key**  
Pressing this key while the unit is not making playback recording, nor deletion places the unit in monitor mode. The Monitor indicator lights during monitor and monitor sound is output from the Headphone output jack (3).  
As monitor sound is not output from the Line output terminals 1 and 2 of the Input/Output terminal (40), you can monitor the audio signal only on the headphones without broadcasting it outside.

**32. CPU RUN indicator (Green)**  
Flashes when the unit is working normally.  
Lights or goes off if the unit malfunctions.

[Rear]

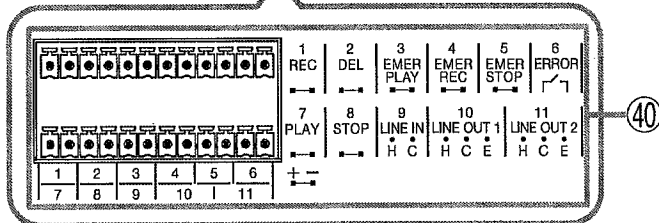
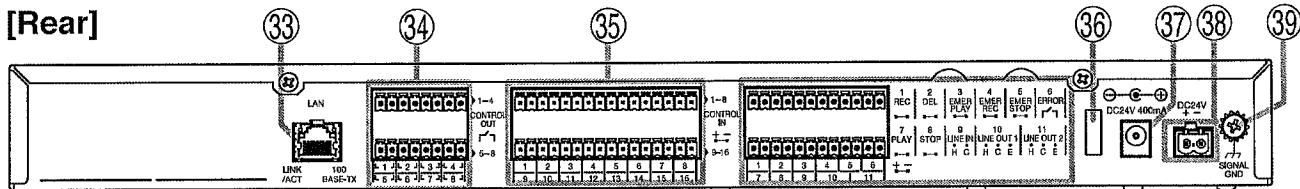

**33. LAN terminal**

Connect this terminal to a 100BASE-TX-compatible network. (Ethernet RJ-45 Jack)  
 (See the EV-700 Setting software instruction manual.)

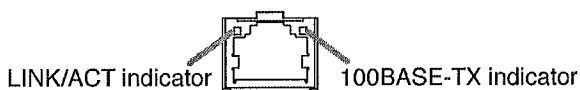

- LINK/ACT indicator  
Lights when the unit is connected to a network or flashes during data transmission or reception.  
**Tip:** Lights or flashes synchronously with the front-mounted LINK/ACT indicator (21).
- 100BASE-TX indicator  
Lights when connected to a 100BASE-TX network.

**34. Contact control output terminals 1 through 8**

Output a make contact during operation of the unit such as during program playback.  
 The Control outputs 1 through 8 set using the EV-700 Setting software are provided at the Contact control output terminals 1 through 8, respectively.

**35. Contact-activated input terminals 1 – 16**

Close the terminals to play a program, or to record or delete the phrase.  
 (See p. 28, "ACTIVATING OPERATION BY WAY OF EXTERNAL CONTROL.")

**36. Cable clamp**

Wrap the cord around this clamp to prevent the AC adapter plug from coming off. (See p. 93, "AC adapter input terminal.")

**37. AC adapter input terminal**

Connect an optional AD-246 AC adapter to this terminal.  
**Tip:** When applying power to this terminal and the DC power input terminal (38) simultaneously, the higher side voltage is supplied to the EV-700.

**38. DC power input terminal**

Connect 24 V DC power to this terminal.

**39. Functional ground terminal**

Be sure to ground this terminal.

**40. Input/Output terminals**

No.	Name	Function
1	Recording control input terminals	Close these terminals when recording phrases.
2	Delete/Clear control input terminals	Close these terminals when deleting the recorded phrase. Closing these terminals during playback clears the stored playback order. (See p. 36, "Sequential storage playback.")
3	Emergency play control input terminals	Close these terminals when making emergency playback.
4	Emergency recording control input terminals	Close these terminals when making R.E.M. playback (p. 63). <b>Tip:</b> Audio files for the emergency playback cannot be recorded using these terminals.
5	Emergency stop control input terminals	Close these terminals when stopping emergency playback or R.E.M. playback.
6	Error output terminals	These terminals normally remain open, but close when a failure occurs in the equipment or memory card.
7	Playback control input terminals	Close these terminals when playback is made by way of binary control. (See p. 30.)
8	Stop control input terminals	Close these terminals when stopping playback and recording.
9	Line input terminals	Enter audio output from the external player for recording and broadcast.
10	Line output 1 terminals	Output unit's playback signals, microphone input signal, or line input signal.
11	Line output 2 terminals	<b>Tip:</b> These 2 terminals output the same audio signals. Line outputs 1 and 2 can be individually set to ON or OFF using the EV-700 Setting software.

## 8. WORKFLOW

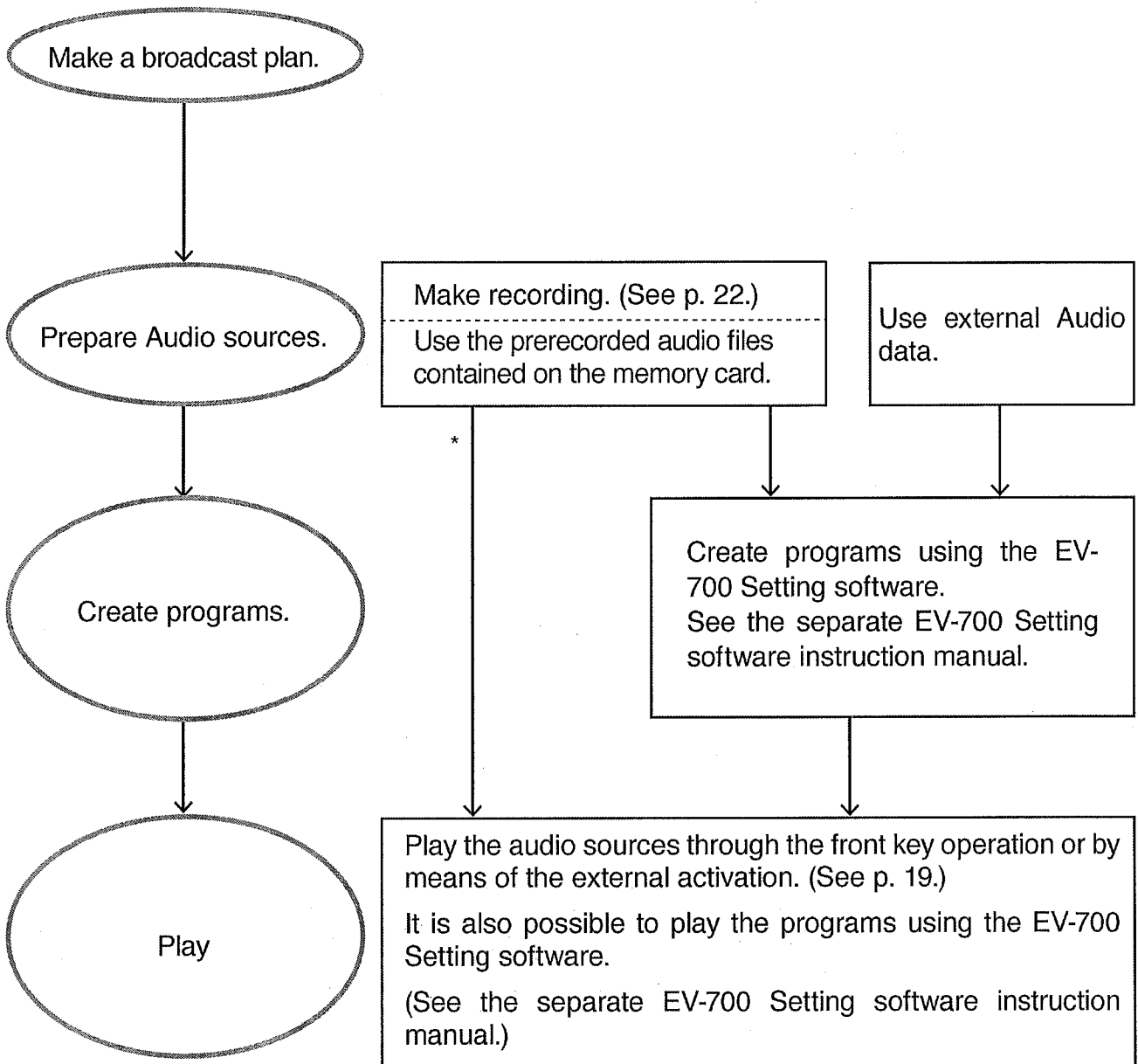

\* Audio sources that can be played without the need for programming are only 8 prerecorded audio files (See p. 18.) which have already been programmed at the factory.

### Tip

To create a program, the EV-700 Setting software recorded on the supplied CD is required.

## 9. TRY TO USE FIRST

Various audio data are stored on the supplied memory card, which are called "Prerecorded audio files." For the contents of prerecorded audio files, read "Prerecorded audio file list" on p. 102.

Program numbers are assigned to these 8 prerecorded audio files by default. They can be played readily in default condition.

The table below shows the prerecorded audio files to which program numbers are assigned.

Program No.	Phrase No.	Content of audio source
P001	00001	2-tone chime
P002	00002	Descending 4-tone chime
P003	00003	Gong
P004	00004	Yelp
P005	00005	Attention please. The fire alarm is indicating a fire. We're now investigating the cause. Please wait for a further information.
P006	00006	There is a fire. Please evacuate as quickly as possible.
P007	00007	Attention please. A few minutes ago, we announced there may be a fire. However, this was a false alarm. Once again, there is no fire.
P008	00008	Ascending 4-tone chime

Explained here is the procedure to play "2-tone chime" of the prerecorded audio files through the front key operation.

### Note

To play other prerecorded audio files than the 8 files listed above, programs need be created on the EV-700 Setting software.

(See the separate EV-700 Setting software instruction manual.)

### Tip

Phrases 00009 through 00016 are assigned to Program Nos. P009 through P016, respectively, by default. When you record audio sources in Phrases 00009 through 00016, you can play them without the need for programming on the EV-700 Setting software.

## 9.1. Connections

Connect each device as shown below. After inserting the supplied memory card into the Memory card slot A, connect the power source to the unit, then turn on the amplifier's power.

Use a single core or 2-core shielded cable for connection between the unit and the amplifier.

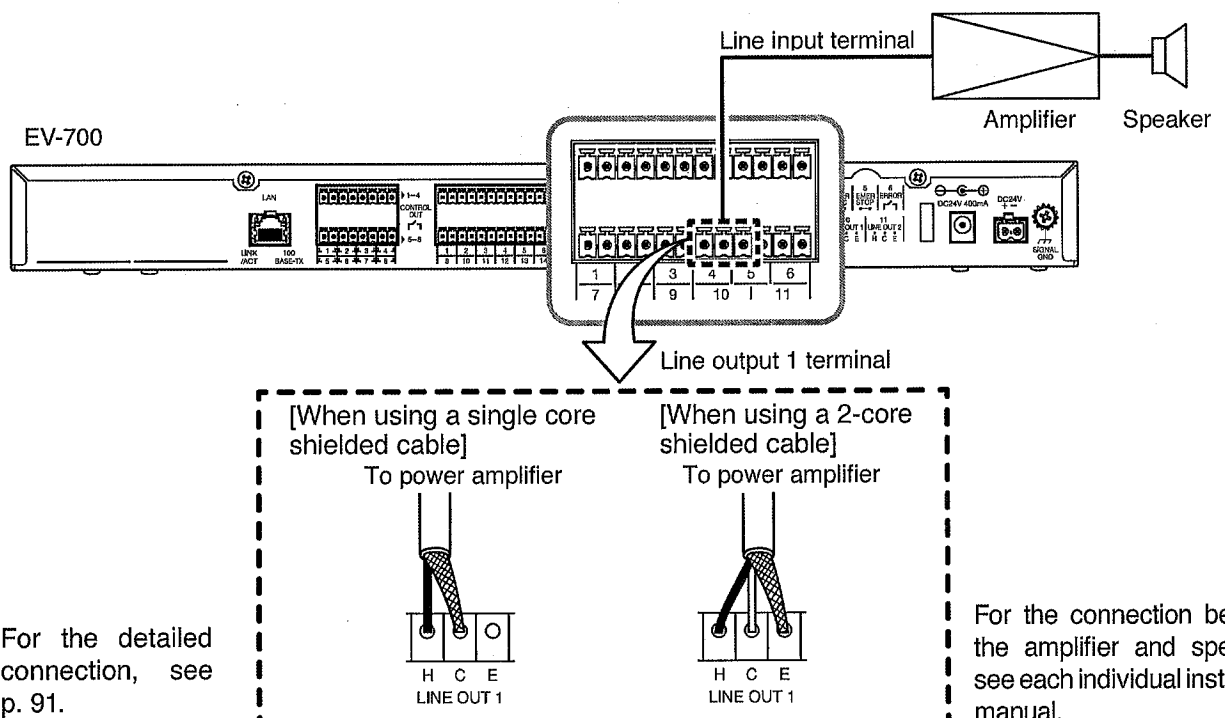

## 9.2. Broadcasting (Playing)

Play the program through the front panel operation.

The following procedures show an example to play "2-tone chime" registered in Program No. 001 (P001).

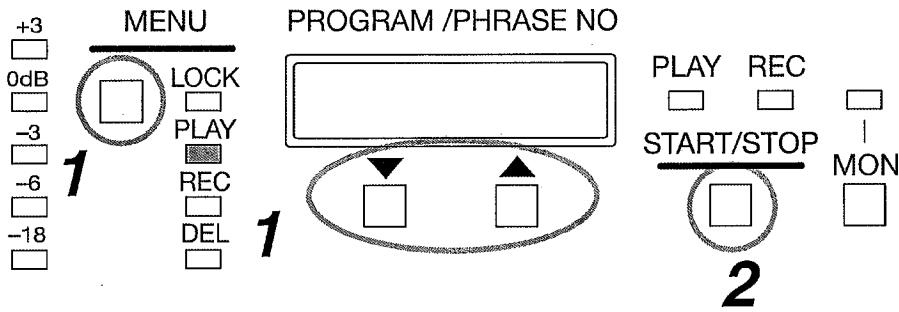

**Step 1.** Press the MENU key to select the play mode.

The PLAY mode indicator lights.

The "PLAY" indication appears for about 1 second on the Status display, followed by the program number indication.

### Tip

Program number is displayed as "P.P.001" (which means Program No. P001) by the factory default.

If the "P.P.001" indication does not appear, press the Up or Down key to display "P.P.001."

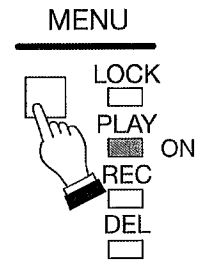

Displayed for 1 second.



(PLAY)

Program number display



**Step 2.** Press the Start/Stop key.

Playback starts.

The Play indicator lights during playback, and the signal level is displayed in the level meter.

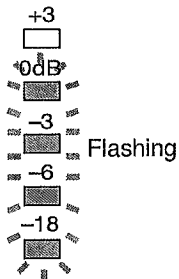

Playback stops automatically when complete.

## 10. PHRASE AND PROGRAM

The terms "Phrase" and "Program" are used for handling audio sources with the EV-700.

### 10.1. What is phrase?

Phrase refers to the audio data (WAV file) recorded on the memory card. A single phrase is created by one-time recording. Up to 32768 pieces of phrase data can be written on the memory card.

"Phrase" used for the EV-700 refers to a WAV file and differs from the Phrase in the general sense. Despite the name "Phrase," audio data for music and sentences can be recorded as phrases.

### 10.2. What is Program?

Program consists of the audio data for broadcast created by combining phrases and the control data such as program sound volume and playback system. Up to 256 programs can be registered.

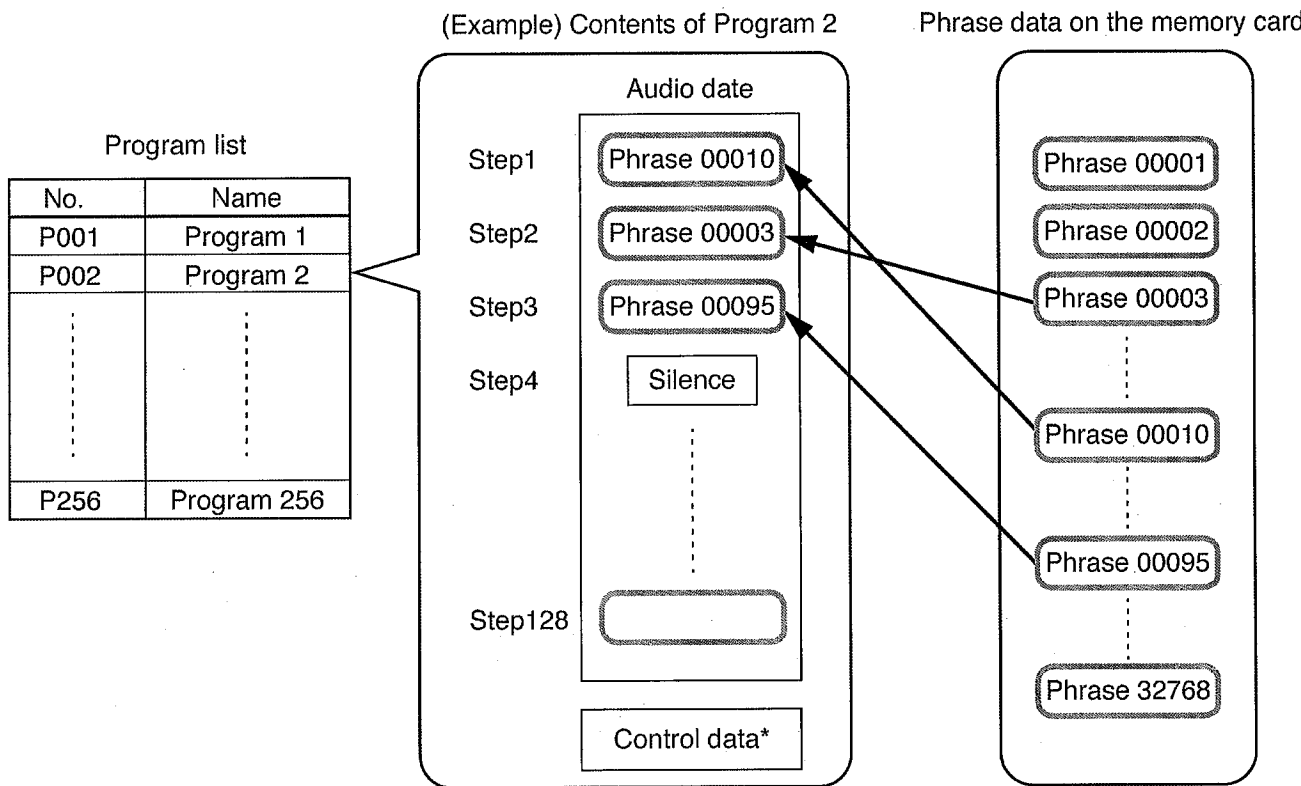

\* See the next page for details.



The Playback order of phrases in a program is referred to as a "Step."  
 A program is created by using one step or combining 2 or more steps.  
 One program can contain up to 128 steps of "Phrases" and "Silent phrases\*."  
 In addition, data of broadcasting method, referred to as "Control data", can be set for individual programs.  
 The following types are available for Control data. See the EV-700 Setting software instruction manual for details.

Control data type	Reference page
Program name	-
Output destination (Line output 1, Line output 2)	p. 12
Playback system (Program playback, Step playback, All phrases playback, and Chime playback)	p. 66
Program sound volume (0 to10)	p. 84
Program playback busy output destination (1 to 8)	p. 86
AGC (ON/OFF)	p. 84
Priority level (2 to 8)	p. 80
Repeat count	p. 66
Repeat time	p. 63
Repeat interval	p. 66
Busy output during repeat interval	p. 66
Interval (Phrase interval)	p. 68
Busy output during interval	p. 69

\* Refers to pause between phrases, which can be adjusted in seconds. It can be created using the EV-700 Setting software.

### 10.3. Playing a Program

Playback is executed for each program.

Your desired program can be selected and played through the front key operation or using the EV-700 Setting software.

In the case of operation by way of Control contact, your desired program can be played by closing the control contact input terminal corresponding to the program.

#### 10.3.1. Program example

##### [Phrase data on the memory card]

Phrase number	Contents
00001	(chime)
00003	the train will be arriving shortly
32768	at track No. 3

##### [Program 1]

- Phrase 00001
- Phrase 00003
- Phrase 32768

Announcement below is broadcast when the Program 1 is played.

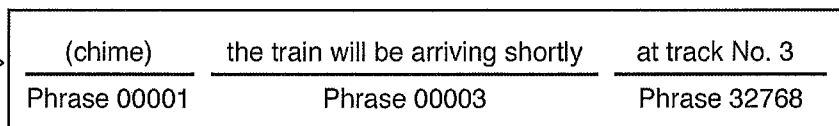

#### Tip

Phrases 00001 through 00016 are registered in Program Nos. P001 through P016, respectively, by default. As audio sources are prerecorded only in Phrases 00001 through 00008, the prerecorded audio file registered in Phrase 00001 is played when Program 001 (P001) is executed. (See p. 18.)

## 10.4. Factory-Preset Program

- The following 8 audio files in the prerecorded audio files (See p. 102, "PRERECORDED AUDIO FILE LIST.") are assigned to Program Nos. P001 through P008 by default. These 8 audio files can be played without the need to create programs using the EV-700 Setting software. For example, "2-tone chime" registered in Phrase No. 00001 is played when P001 is played.
- Phrase Nos. 00009 through 00016 are assigned to Program Nos. P009 through P016, respectively, although sound source data are not registered in those phrase numbers. If sound source data are recorded to Phrase Nos. 00009 through 00016, they can be played without the need to create program using the EV-700 Setting software as in the case of the prerecorded audio files above. For example, the data recorded to Phrase No. 00009 is played when P009 is played.
- Playback system is set to Program playback except "P008 Ascending 4-note tone," which is set to Chime playback. (See p. 66, "PLAYBACK SYSTEMS.")
- When the prerecorded audio files registered to the Phrase Nos. 00001 through 00008 have been deleted through the front key operation, you can record other audio files to those phrase numbers. In this case, they can be played without the need to create program using the EV-700 Setting software as is the case described above. The prerecorded audio files deleted in this method can be registered again from the memory card using the EV-700 Setting software.

Program No.	Phrase No.	Content of audio source
P001	00001	2-tone chime
P002	00002	Descending 4-tone chime
P003	00003	Gong
P004	00004	Yelp
P005	00005	Attention please. The fire alarm is ...
P006	00006	There is a fire. Please eva...
P007	00007	Attention please. A few mi...
P008	00008	Ascending 4-tone chime
P009	00009	Unregistered
P010	00010	
P011	00011	
P012	00012	
P013	00013	
P014	00014	
P015	00015	
P016	00016	

# 11. OPERATION

Using the front panel-mounted keys, play, recording, and deletion can be made.

The same operation can be performed by way of contact control. (See p. 28, "ACTIVATING OPERATION BY WAY OF EXTERNAL CONTROL.")

## Note

Program cannot be created through the front key operation. To create program, use the EV-700 Setting software. (See the EV-700 Setting Software instruction manual.)

### 11.1. Playing a Program

To play a program, designate the program number.

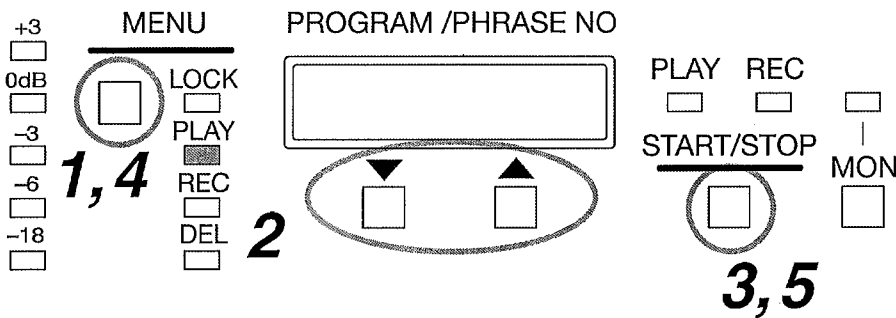

#### Step 1. Press the Menu key to select play mode.

Press the Menu key some times until the Play mode indicator lights.

The "PLAY" indication appears for about 1 second on the Status display, followed by the program number indication.

#### Tip

Program No. is displayed by 2-letter alphabets and 3-digit number. First figure "P." represents program and the second figure represents playback system.

(Example)

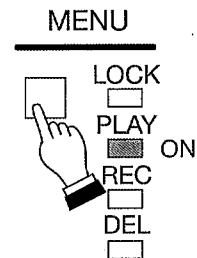
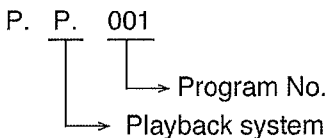

Displayed for 1 second.



(PLAY)

Program number display



The table below shows play methods.

For the details of playback systems, see p. 66, "PLAYBACK SYSTEMS."

Code	Playback system
<b>P.</b> (P.)	Program playback
<b>S.</b> (S.)	Step playback
<b>A.</b> (A.)	All phrases playback
<b>C.</b> (C.)	Chime playback

**Step 2.** Press either the Up or Down key to select Program number to be played.

**Tip**

You can monitor the content to be played using headphones before play. (See p. 27, "Confirming the Recorded Contents on Memory Card.")

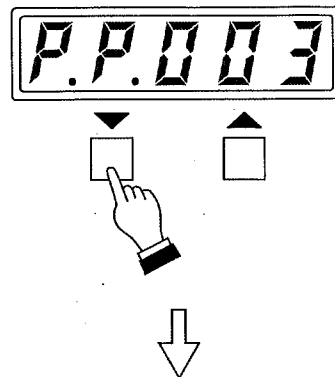

**Step 3.** Press the Start/Stop key.

Playback starts according to the control data of the program.

The Play indicator lights during playback, and the signal level is displayed in the level meter.

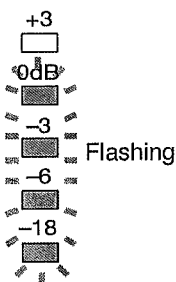
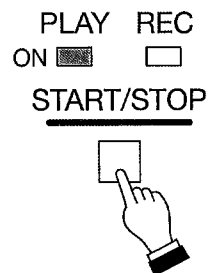

[To disable each key operation]

Press the Menu key to select Lock mode.

The Lock mode indicator lights.

Key operation except the Menu key is disabled, preventing accidental wrong operation.

To cancel Lock mode, press the Menu key again.

**Tip**

The unit is automatically placed in Lock mode after 5 minutes from playback start.

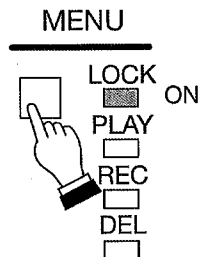

**Step 4.** To stop playback partway, press the Start/Stop key again.

The Play indicator goes off.

**Tip**

After you finish all necessary operations, it is recommended that you place the unit in Lock mode to prevent accidental operation. (See p. 27, "Disabling Each Key Operation on the Front Panel (Lock Mode).")

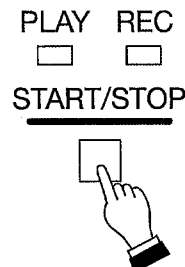

## 11.2. Stopping Program Playback

Program playback automatically stops after the preset repeat count of broadcasts when set to Pulse signal input activation (p. 33), but you can stop it manually.

Program playback can be stopped following the procedures below even if it is started in any of the methods using the EV-700 Setting software, control input, or through front panel operation.

**Step 1.** Press the Menu key to select the play mode.

Press the Menu key some times until the Play mode indicator lights.

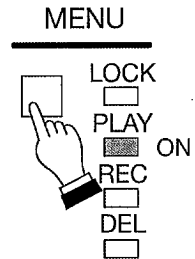

**Step 2.** Press the Start/Stop key.

Playback stops and the Play indicator goes off.

### Tip

After you finish all necessary operations, it is recommended that you place the unit in Lock mode to prevent accidental operation.

(See p. 27, "Disabling Each Key Operation on the Front Panel (Lock Mode).")

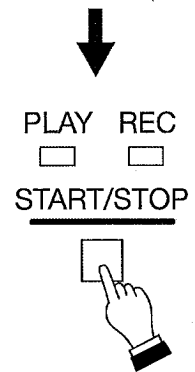

### 11.3. Recording to Phrase

Designate the phrase number, then record the sound source to it.

**Tips**

- Recording is made with a sampling frequency of 44.1 kHz by factory default.
- The sampling frequency can be changed using the EV-700 Setting software.

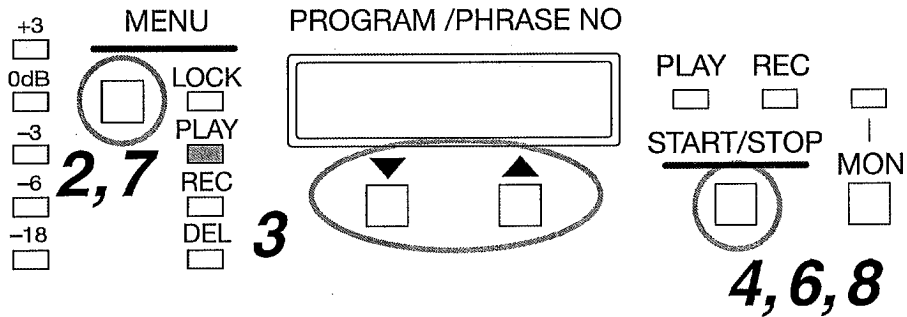

**Step 1.** Connect a microphone or sound source equipment such as player to the EV-700.  
(See p. 91, "CONNECTIONS.")

**Step 2.** Press the Menu key to select Recording mode.  
Press the Menu key some times until the Recording mode indicator lights.  
The "rEC" (REC) indication appears for about 1 second on the Status display, followed by the Phrase number indication like "00001."

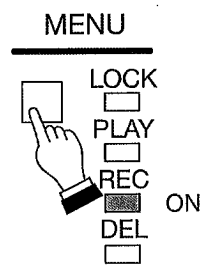

Displayed for 1 second.

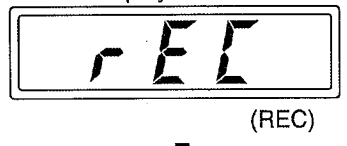

**Step 3.** Press either the Up or Down key to select the Phrase number to be recorded.  
A recordable phrase number will flash.

**Note**

If a phrase number does not flash, this indicates that this phrase number has already been registered.  
In this case, pressing the Start/Stop key in the next Step 4 causes the indication below to appear for about 1 second, then the display returns to the original phrase number indication.

Phrase number display

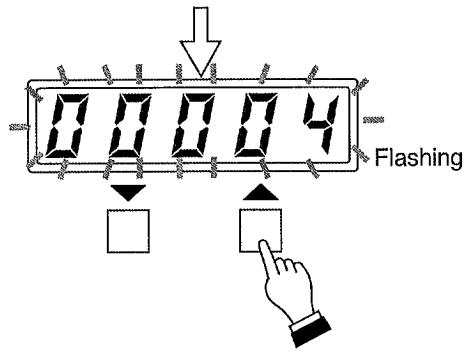
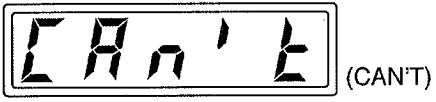

**Tips**

- Phrase Nos. 00009 through 00016 are assigned to the Program Nos. P009 through P016, respectively and no prerecorded audio source is registered there by factory default.  
So, the audio source recorded to one of these phrase numbers can be played instantly if the corresponding program number is designated.
- You can monitor the registered recorded contents using headphones.  
(See p. 27, "Confirming the Recorded Contents on Memory Card.")

**Step 4.** Adjust the sound volume of the sound source to record.

Adjust the sound volume of the sound source with the Microphone input volume control or Line input volume control while watching the level meter.

Take care so that "+3" LED of the level meter is not constantly lighting.

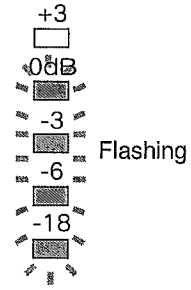

Front panel

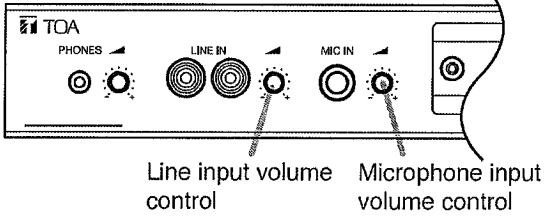

**Tip**

You can monitor the content of the sound source to be recorded using headphones.

**Step 5.** Press the Start/Stop key.

The "rEAdy" (READY) indication appears on the Status display, then the unit will be placed in Recording standby mode.

The Recording indicator and the dot at the lower right corner of the Status display flash during Recording standby.

**Tip**

If you do not make any front panel operation for 5 minutes, the display's status will return to the one in Step 3.

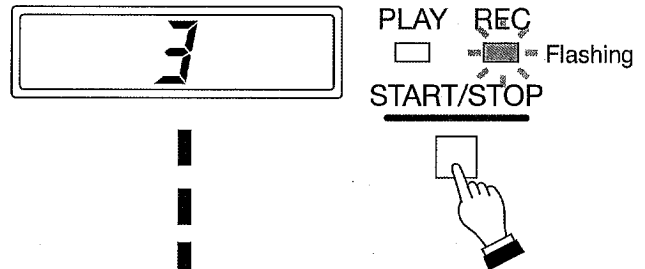
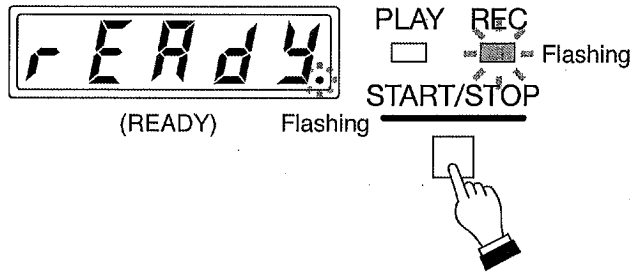

**Step 6.** Press the Start/Stop key again.

Recording will start after 3 seconds. Remaining seconds appear from "3" to "1" on countdown signs on the Status display.

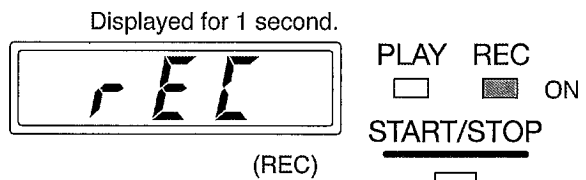
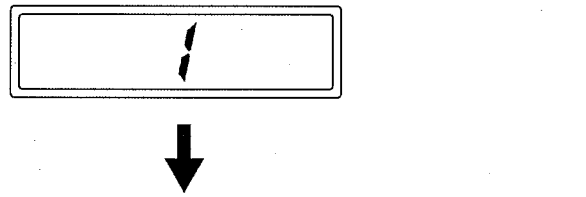

When recording starts, the Recording indicator lights and the "rEC" (REC) indication appears for about 1 second on the Status display, followed by the recording Phrase number indication.

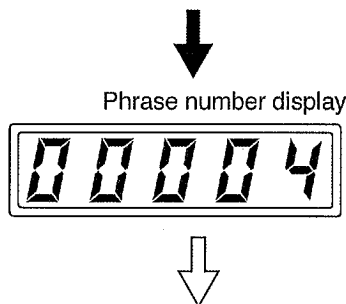

**Step 7.** Speak into the microphone or play the sound source by a player.

[To disable each key operation]

Press the Menu key to place the unit in Lock mode.

The Lock mode indicator lights.

Key operation except the Menu key is disabled, preventing accidental wrong operation.

To cancel Lock mode, press the Menu key again.

**Tips**

- The unit is automatically placed in Lock mode after 5 minutes from playback start.
- Sound source can be recorded in a single phrase up to 2 hours. Recording stops when the recording time for a single phrase exceeds 2 hours or the memory card becomes full.

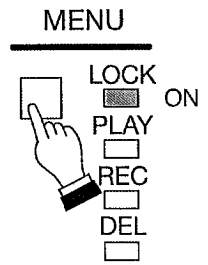

**Step 8.** To stop recording, press the Start/Stop key.

The Recording indicator goes off.

**Tip**

After you finish all necessary operations, it is recommended that you place the unit in Lock mode to prevent accidental operation.

(See p. 27, "Disabling Each Key Operation on the Front Panel (Lock Mode).")

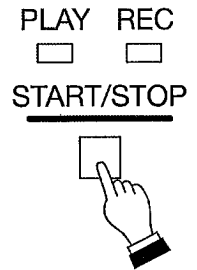



## 11.4. Deleting Phrase

Designate the phrase number, then delete the audio source.

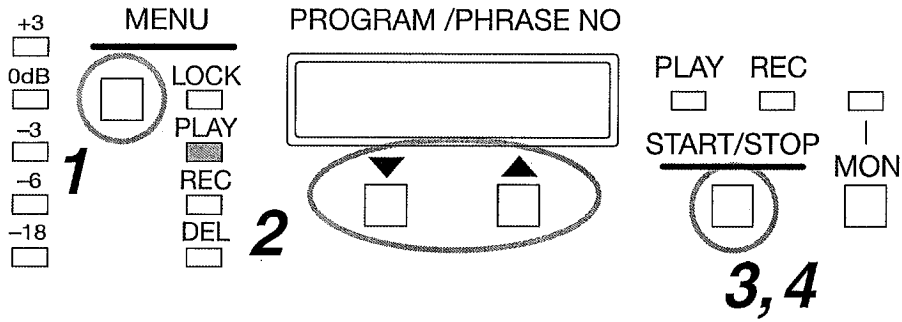

- Step 1.** Press the Menu key to select Delete mode.  
 Press the Menu key some times until the Delete mode indicator lights.  
 The "dEL" (DEL) indication appears for about 1 second on the Status display, then followed by the Phrase number indication like "00001."

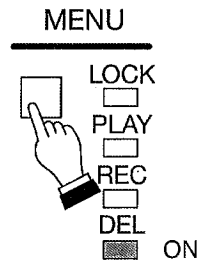

Displayed for 1 second.

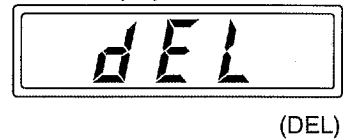

Phrase number display



- Step 2.** Press either the Up or Down key to select the phrase number to be deleted.

**Tip**

You can monitor the selected phrase contents using headphones before deleting.  
 (See p. 27, "Confirming the Recorded Contents on Memory Card.")

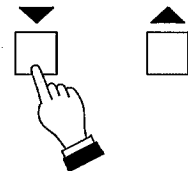

**Step 3.** Press the Start/Stop key.

The "rEAdy" (READY) indication appears on the Status display, then the unit will be placed in Delete standby mode.

The dot at the lower right corner of the Status display flashes during Delete standby.

**Tip**

If you do not make any front panel operation for 5 minutes, display's status will return to the one in Step 2.

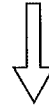
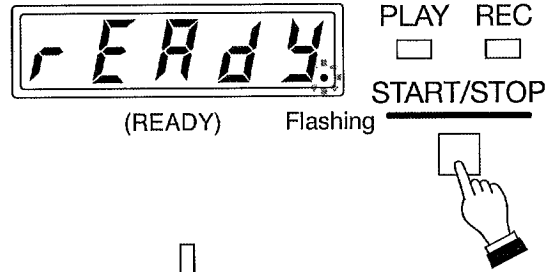

**Step 4.** Press the Start/Stop key again.

The phrase will be deleted.

The "dEL" (DEL) indication appears on the Status display, followed by the flashing indication of the phrase number during deletion.

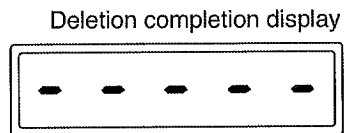
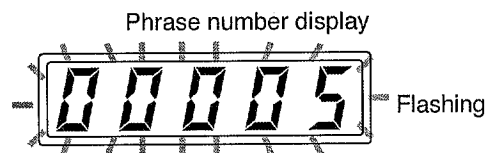
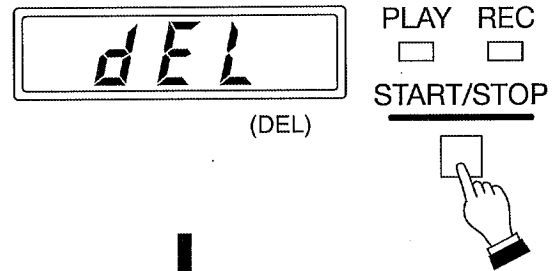

Hyphens appear when the deletion is complete, then the display's indication changes to other phrase number indication.

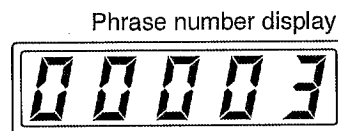

**Tip**

After you finish all necessary operations, it is recommended that you place the unit in Lock mode to prevent accidental operation. (See p. 27, "Disabling Each Key Operation on the Front Panel (Lock Mode).")

## 11.5. Confirming the Recorded Contents on Memory Card

Follow the procedures below to confirm the recorded contents on memory card before playing, recording, or deleting them. Audio signals are not output from the Line outputs 1 and 2 but you can check the contents using the headphones connected to the Headphone output jack.

**Step 1.** Select a phrase number or program number for each operation of playback, recording, and deletion.

For playback, select a program number.

(Refer to Step 2 on p. 20.)

For recording, select a phrase number.

(Refer to Step 3 on p. 22.)

For deletion, select a phrase number.

(Refer to Step 2 on p. 25.)

**Step 2.** Press the Monitor key.

The Monitor indicator lights, and the selected sound source is played and output through the headphone output jack.

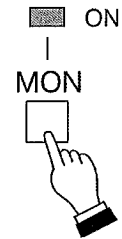

**Step 3.** To stop monitoring partway through the playback, press the Monitor key again.

The Monitor indicator goes off and monitor is terminated.

### Tip

After playback of the selected audio source is complete, the Monitor indicator goes off automatically and monitor will be terminated.

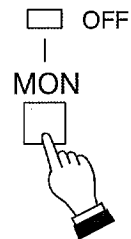

## 11.6. Disabling Each Key Operation on the Front Panel (Lock Mode)

After you finish all necessary front key operations, place the unit in Lock mode.

Key operation except the Menu key is disabled, preventing accidental wrong operation.

### 11.6.1. Placing in Lock mode

Press the Menu key to select Lock mode.

The Lock mode indicator lights, then the unit is placed in Lock mode.

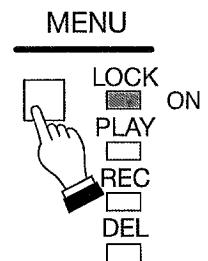

### 11.6.2. Cancelling Lock mode

Press the Menu key while in Lock mode (when the Lock mode indicator is lighting).

The Lock mode indicator goes off, and the Lock mode is cancelled.

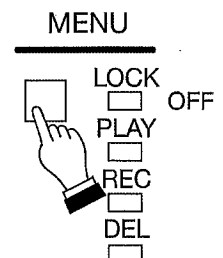

## 12. ACTIVATING OPERATION BY WAY OF EXTERNAL CONTROL

Each operation of playback, recording, delete/clear, stop, and emergency broadcast can be activated by inputting a make signal when external control equipment such as a Timer is connected to the Contact-activated input terminals and various Contact input terminals on the EV-700's rear panel.

### Tip

Operation contents such as the program number being broadcast appear on the Status display during each operation executed by the external control.

### 12.1. Setting the Control Method

Use the EV-700 Setting software to perform settings related to external activation such as a control method and control signal type.

[Setting example (default setting)]

#### Startup mode

Control function  Direct  Binary

Startup target	Type	Operation
Playback start	<input checked="" type="radio"/> Pulse <input type="radio"/> Level	<input checked="" type="radio"/> Priority setting (FIFO) <input type="radio"/> Priority setting (LIFO) <input type="radio"/> Sequential storage
Recording start	<input checked="" type="radio"/> Pulse <input type="radio"/> Level	
Stop activation	Pulse	<input checked="" type="radio"/> Forced stop <input type="radio"/> Spontaneous stop of phrase playback
Emergency playback	<input checked="" type="radio"/> Pulse <input type="radio"/> Level	
Emergency stop	Pulse	<input checked="" type="radio"/> Forced stop <input type="radio"/> Spontaneous stop of phrase playback

See the EV-700 Setting software instruction manual for details.

#### [Outline of Setting and operation]

- First, set the control function to either "Direct" or "Binary." The set control function applies to playback start, recording start, delete/clear start, and stop activation.
- For the emergency playback start and emergency stop activation, operations are the same no matter which "Direct" or "Binary" is selected.
- Details of control (Type and operation) can be set for each activated operation.
- Settings and operations related to "Recording start"
  - You cannot make an overwrite recording on the existing phrase. When recording a phrase again, be sure to delete the existing one first.
  - Shown below are the numbers of phrases that can be recorded by external activation.
    - When in Direct mode: 16 phrases (00001 to 00016)
    - When in Binary mode: 256 phrases (00001 to 00256)
  - Recorded phrases are all registered on the Memory card A.

## 12.2. Inputting Control Signals

### 12.2.1. Input terminals used for external activation

Apply a make signal to the Contact-activated input terminals and another make signal to the control input terminals for activating each operation.

Use the Contact-activated input terminals to select a playback program number or the phrase number to be recorded/deleted.

Use the Control input terminals to select each operation of playback, recording, delete/clear, stop, or emergency broadcast.

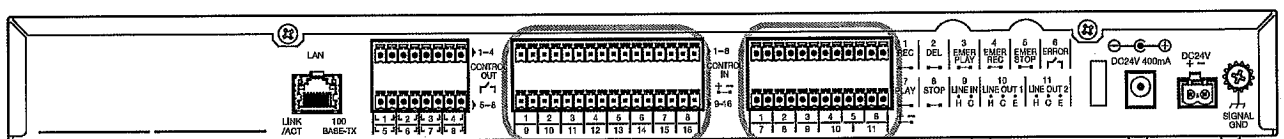

Contact-activated input terminals

Control input terminals in the Input/output terminal block

### 12.2.2. Activation by a make signal

To perform external activation, apply a make signal to the Contact-activated/Control input terminals. The terminal contacts are normally open, and activation is triggered when closed.

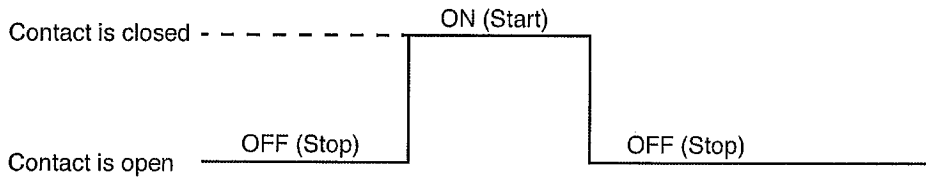

#### Notes

- A make signal needs to be kept ON for 50 ms or more. As it takes about 30 to 50 ms until the unit is activated after a make signal has been applied to the unit, the unit may not work if the closed duration is less than 50 ms.

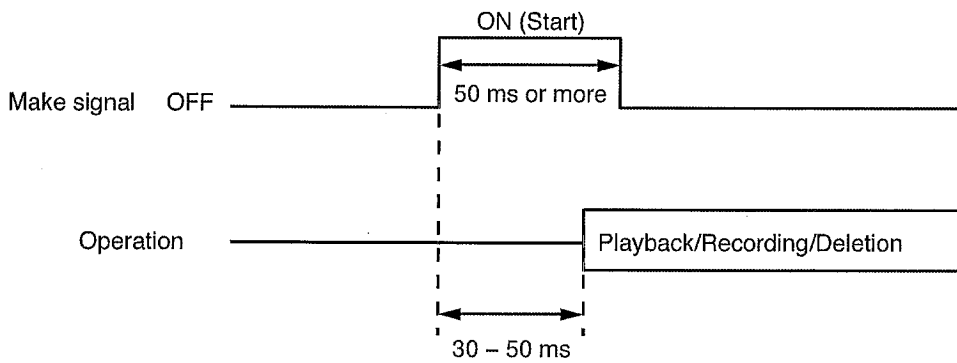

When 2 or more make signals need be input in sequence, allow at least 50 ms interval between first signal input and second signal input.

If this interval is shorter than 50 ms, operation may not be performed in correct order.

- Note that the time interval of 30 ms to 50 ms is omitted in the subsequent diagrams.

## 12.3. Details of the Setting Items

### 12.3.1. Direct control function and Binary control function

Direct control function: Allows operation such as playback of the program number or recording/deletion of the phrase number corresponding to such terminal when a make signal is applied to any one of the Contact-activated input terminals 1 through 16.

Binary control function: Allows selection of 1 to 256 programs by recognizing the open/closed states of the Contact-activated input terminals 1 through 8 as 8-binary digits.

#### [Activation by the Direct control function]

For playback start, each of the Contact-activated input terminals 1 through 16 corresponds to the program number.

For recording start or deletion start, each of the Contact-activated input terminals 1 through 16 corresponds to the phrase number.

(See the table below.)

Contact-activated input terminal No.	Playback start	Recording/Deletion start
	Program No.	Phrase No.
1	P001	00001
2	P002	00002
3	P003	00003
4	P004	00004
5	P005	00005
6	P006	00006
7	P007	00007
8	P008	00008
9	P009	00009
10	P010	00010
11	P011	00011
12	P012	00012
13	P013	00013
14	P014	00014
15	P015	00015
16	P016	00016

For the details of activation by Direct control function, see p. 39.

**[Activation by the Binary control function]**

The Contact-activated input terminals 1 through 8 are regarded as 8 binary digits comprised of "0" and "1" when assuming the closed state as "1" and the open state as "0."

To start playback, close the Playback control input terminal after designating the target program number, then the program of the designated number is played. Similarly, to start recording or deletion, close the Recording or Deletion control terminal after designating the target phrase number, then the phrase of the designated number is recorded or deleted.

For example, place the Contact-activated input terminals 1 through 8 in the following states.

Contact-activated input terminal	1	2	3	4	5	6	7	8
Terminal state (0: Open, 1: Closed)	1	0	1	0	0	0	0	0

The table on the next page shows that a set of the terminal states is designating P006. P006 will be played if the Playback control input terminal is closed under these states.

For the details of activation by the Binary control function, see p. 45.

**Note**

Numbers designated by the unit's Binary control function differ from those expressed in binary notation. For example, P001 is designated when the terminal state is placed in "00000000" and P002 if placed in "10000000."

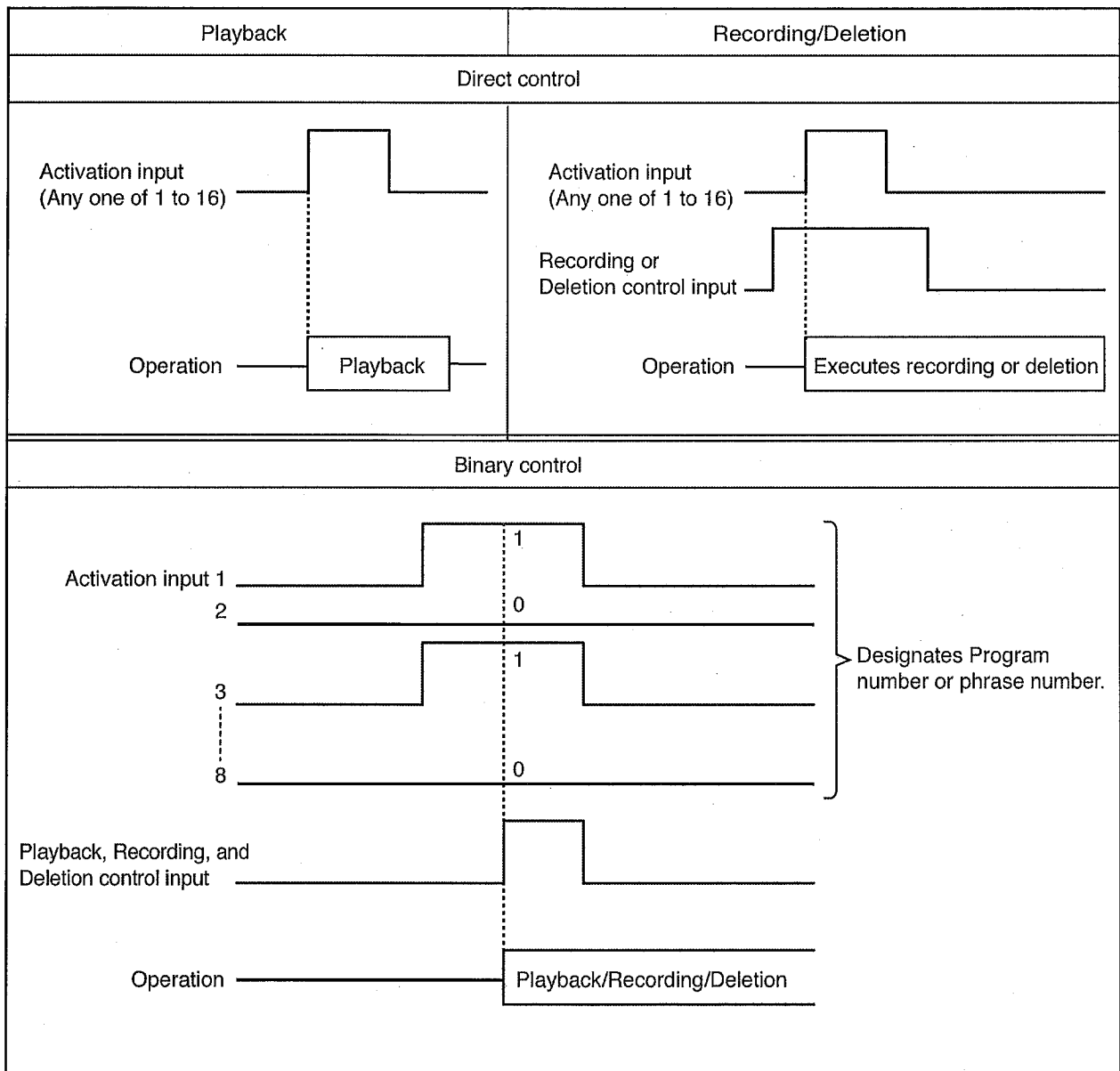

The above table shows operation activated by a Pulse signal input.

[States of Contact-activated input terminals 1 to 8 by the Binary control function]

Contact-activated input terminal								Recording/Delection	Playback	Contact-activated input terminal								Recording/Delection	Playback	Contact-activated input terminal								Recording/Delection	Playback	Contact-activated input terminal								Recording/Delection	Playback										
1	2	3	4	5	6	7	8	Phrase No.	Program No.	1	2	3	4	5	6	7	8	Phrase No.	Program No.	1	2	3	4	5	6	7	8	Phrase No.	Program No.	1	2	3	4	5	6	7	8	Phrase No.	Program No.	1	2	3	4	5	6	7	8	Phrase No.	Program No.
0	0	0	0	0	0	0	0	00001	P001	0	0	0	0	0	1	0	00065	P065	0	0	0	0	0	0	1	00129	P129	0	0	0	0	0	1	1	00193	P193													
1	0	0	0	0	0	0	0	00002	P002	1	0	0	0	0	1	0	00066	P066	1	0	0	0	0	0	1	00130	P130	1	0	0	0	0	1	1	00194	P194													
0	1	0	0	0	0	0	0	00003	P003	0	1	0	0	0	1	0	00067	P067	0	1	0	0	0	0	1	00131	P131	0	1	0	0	0	1	1	00195	P195													
1	1	0	0	0	0	0	0	00004	P004	1	1	0	0	0	1	0	00068	P068	1	1	0	0	0	0	1	00132	P132	1	1	0	0	0	1	1	00196	P196													
0	0	1	0	0	0	0	0	00005	P005	0	0	1	0	0	1	0	00069	P069	0	0	1	0	0	0	1	00133	P133	0	0	1	0	0	1	1	00197	P197													
1	0	1	0	0	0	0	0	00006	P006	1	0	1	0	0	1	0	00070	P070	1	0	1	0	0	0	1	00134	P134	1	0	1	0	0	1	1	00198	P198													
0	1	1	0	0	0	0	0	00007	P007	0	1	1	0	0	1	0	00071	P071	0	1	1	0	0	0	1	00135	P135	0	1	1	0	0	1	1	00199	P199													
1	1	1	0	0	0	0	0	00008	P008	1	1	1	0	0	1	0	00072	P072	1	1	1	0	0	0	1	00136	P136	1	1	1	0	0	1	1	00200	P200													
0	0	0	1	0	0	0	0	00009	P009	0	0	0	1	0	1	0	00073	P073	0	0	0	1	0	0	1	00137	P137	0	0	0	1	0	1	1	00201	P201													
1	0	0	1	0	0	0	0	00010	P010	1	0	0	1	0	1	0	00074	P074	1	0	0	1	0	0	1	00138	P138	1	0	0	1	0	1	1	00202	P202													
0	1	0	1	0	0	0	0	00011	P011	0	1	0	1	0	1	0	00075	P075	0	1	0	1	0	0	1	00139	P139	0	1	0	1	0	1	1	00203	P203													
1	1	0	1	0	0	0	0	00012	P012	1	1	0	1	0	1	0	00076	P076	1	1	0	1	0	0	1	00140	P140	1	1	0	1	0	1	1	00204	P204													
0	0	1	1	0	0	0	0	00013	P013	0	0	1	1	0	1	0	00077	P077	0	0	1	1	0	0	1	00141	P141	0	0	1	1	0	1	1	00205	P205													
1	0	1	1	0	0	0	0	00014	P014	1	0	1	1	0	1	0	00078	P078	1	0	1	1	0	0	1	00142	P142	1	0	1	1	0	1	1	00206	P206													
0	1	1	1	0	0	0	0	00015	P015	0	1	1	1	0	1	0	00079	P079	0	1	1	1	0	0	1	00143	P143	0	1	1	1	0	1	1	00207	P207													
1	1	1	1	0	0	0	0	00016	P016	1	1	1	1	0	1	0	00080	P080	1	1	1	1	0	0	1	00144	P144	1	1	1	1	0	1	1	00208	P208													
0	0	0	0	1	0	0	0	00017	P017	0	0	0	0	1	0	1	00081	P081	0	0	0	0	1	0	1	00145	P145	0	0	0	0	1	0	1	00209	P209													
1	0	0	0	1	0	0	0	00018	P018	1	0	0	0	1	0	1	00082	P082	1	0	0	0	1	0	1	00146	P146	1	0	0	0	1	0	1	00210	P210													
0	1	0	0	1	0	0	0	00019	P019	0	1	0	0	1	0	1	00083	P083	0	1	0	0	1	0	1	00147	P147	0	1	0	0	1	0	1	00211	P211													
1	1	0	0	1	0	0	0	00020	P020	1	1	0	0	1	0	1	00084	P084	1	1	0	0	1	0	1	00148	P148	1	1	0	0	1	0	1	00212	P212													
0	0	1	0	1	0	0	0	00021	P021	0	0	1	0	1	0	1	00085	P085	0	0	1	0	1	0	1	00149	P149	0	0	1	0	1	0	1	00213	P213													
1	0	1	0	1	0	0	0	00022	P022	1	0	1	0	1	0	1	00086	P086	1	0	1	0	1	0	1	00150	P150	1	0	1	0	1	0	1	00214	P214													
0	1	1	0	1	0	0	0	00023	P023	0	1	1	0	1	0	1	00087	P087	0	1	1	0	1	0	1	00151	P151	0	1	1	0	1	0	1	00215	P215													
1	1	1	0	1	0	0	0	00024	P024	1	1	1	0	1	0	1	00088	P088	1	1	1	0	1	0	1	00152	P152	1	1	1	0	1	0	1	00216	P216													
0	0	0	1	1	0	0	0	00025	P025	0	0	0	1	1	0	1	00089	P089	0	0	0	1	1	0	1	00153	P153	0	0	0	1	1	0	1	00217	P217													
1	0	0	1	1	0	0	0	00026	P026	1	0	0	1	1	0	1	00090	P090	1	0	0	1	1	0	1	00154	P154	1	0	0	1	1	0	1	00218	P218													
0	1	0	1	1	0	0	0	00027	P027	0	1	0	1	1	0	1	00091	P091	0	1	0	1	1	0	1	00155	P155	0	1	0	1	1	0	1	00219	P219													
1	1	0	1	1	0	0	0	00028	P028	1	1	0	1	1	0	1	00092	P092	1	1	0	1	1	0	1	00156	P156	1	1	0	1	1	0	1	00220	P220													
0	0	1	1	1	0	0	0	00029	P029	0	0	1	1	1	0	1	00093	P093	0	0	1	1	1	0	1	00157	P157	0	0	1	1	1	0	1	00221	P221													
1	0	1	1	1	0	0	0	00030	P030	1	0	1	1	1	0	1	00094	P094	1	0	1	1	1	0	1	00158	P158	1	0	1	1	1	0	1	00222	P222													
0	1	1	1	1	0	0	0	00031	P031	0	1	1	1	1	0	1	00095	P095	0	1	1	1	1	0	1	00159	P159	0	1	1	1	1	0	1	00223	P223													
1	1	1	1	1	0	0	0	00032	P032	1	1	1	1	1	0	1	00096	P096	1	1	1	1	1	0	1	00160	P160	1	1	1	1	1	0	1	00224	P224													
0	0	0	0	1	0	0	0	00033	P033	0	0	0	0	1	1	0	00097	P097	0	0	0	0	1	1	0	00161	P161	0	0	0	0	1	1	0	00225	P225													
1	0	0	0	1	0	0	0	00034	P034	1	0	0	0	1	1	0	00098	P098	1	0	0	0	1	1	0	00162	P162	1	0	0	0	1	1	0	00226	P226													
0	1	0	0	1	0	0	0	00035	P035	0	1	0	0	1	1	0	00099	P099	0	1	0	0	1	1	0	00163	P163	0	1	0	0	1	1	0	00227	P227													
1	1	0	0	1	0	0	0	00036	P036	1	1	0	0	1	1	0	00100	P100	1	1	0	0	1	1	0	00164	P164	1	1	0	0	1	1	0	00228	P228													
0	0	1	0	0	1	0	0	00037	P037	0	0	1	0	0	1	1	00101	P101	0	0	1	0	0	1	1	00165	P165	0	0	1	0	0	1	1	00229	P229													
1	0	1	0	0	1	0	0	00038	P038	1	0	1	0	0	1	1	00102	P102	1	0	1	0	0	1	1	00166	P166	1	0	1	0	0	1	1	00230	P230													
0	1	1	0	0	1	0	0	00039	P039	0	1	1	0	0	1	1	00103	P103	0	1	1	0	0	1	1	00167	P167	0	1	1	0	0	1	1	00231	P231													
1	1	1	0	0	1	0	0	00040	P040	1	1	1	0	0	1	1	00104	P104	1	1	1	0	0	1	1	00168	P168	1	1	1	0	0	1	1	00232	P232													
0	0	0	1	0	0	1	0	00041	P041	0	0	0	1	0	1	1	00105	P105	0	0	0	1	0	1	1	00169	P169	0	0	0	1	0	1	1	00233	P233													
1	0	0	1	0	0	1	0	00042	P042	1	0	0	1	0	1	1	00106	P106	1	0	0	1	0	1	1	00170	P170	1	0	0	1	0	1	1	00234	P234													
0	1	0	1	0	0	1	0	00043	P043	0	1	0	1	0	1	1	00107	P107	0	1	0	1	0	1	1	00171	P171	0	1	0	1	0	1	1	00235	P235													
1	1	0	1	0	0	1	0	00044	P044	1	1	0	1	0	1	1	00108	P108	1	1	0	1	0	1	1	00172	P172	1	1	0	1	0	1	1	00236	P236													
0	0	1	1	0	0	1	0	00045	P045	0	0	1	1	0	1	1	00109	P109	0	0	1	1	0	1	1	00173	P173	0	0	1	1	0	1	1	00237	P237													
1	0	1	1	0	0	1	0	00046	P046	1	0	1	1	0	1	1	00110	P110	1	0	1	1	0	1	1	00174	P174	1	0	1	1	0	1	1	00238	P238													
0	1	1	1	0	0	1	0	00047	P047	0	1	1	1	0	1	1	00111	P111	0	1	1	1	0	1	1	00175	P175	0	1	1	1	0	1	1	00239	P239													
1	1	1	1</																																														



### 12.3.2. Pulse signal input activation and Level signal input activation

Pulse signal input activation: Activates operation when a make signal (Closed time duration: over 50 ms) is applied to the terminals. Operation stops when it is finished or when a make signal is applied to the Stop control input.

Level signal input activation: Activates operation when a make signal is applied to the terminals, and continues the operation while the terminals are being closed. Playback is repeated when a closed state is maintained even if playback is finished.

#### [Operation by Pulse signal input activation] (When Direct control function is selected)

- Operation of playback start by Pulse signal input activation

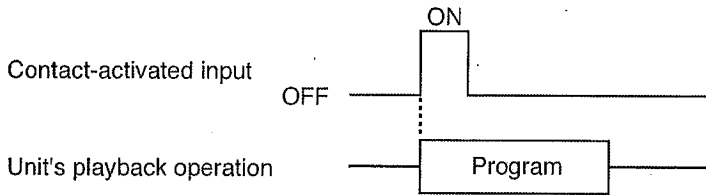

- Operations of playback start by Pulse signal input activation and Stop activation during playback.

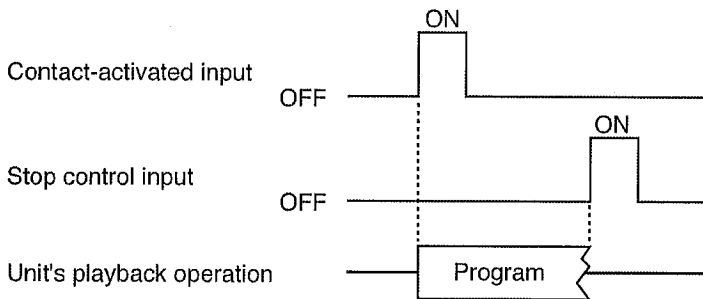

#### Note

When set to Pulse signal input activation, playback is not repeated even if a closed state is kept at the end of the program playback.

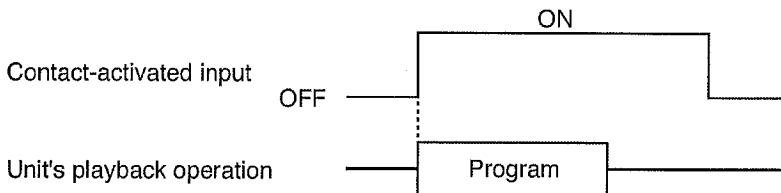

**[Operation by Level signal input activation] (When Direct control function is selected)**

- Operation of playback start by Level signal input activation

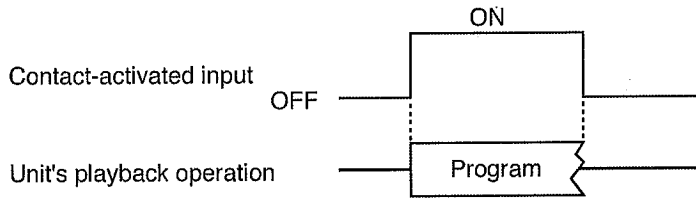

- Operation when playback is started by Level signal input activation and the closed state is kept even after program completion

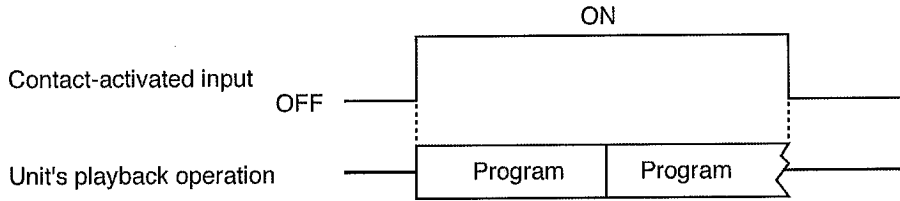

**Note**

When set to Level signal input activation, playback continues only during the interval if terminals are closed for a short time.

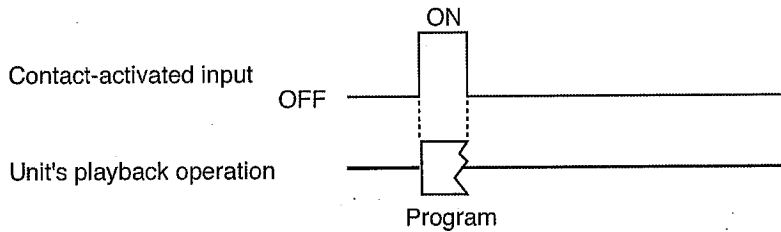

### 12.3.3. Operation setting for playback start

Three methods are available for the operation settings: Priority setting (FIFO), Priority setting (LIFO), and Sequential storage playback.

#### [Playback depending on Priority setting (FIFO) and Priority setting (LIFO)]

The unit operates as shown below depending on the program priority levels when playback is performed by these two settings.

When the set priority levels are different: A higher-priority program's playback takes precedence

When the set priority levels are the same: The unit performs different operations as shown in the table below depending on which the priority is set to FIFO or LIFO.

When playback of other program with the same priority level is started during program playback	FIFO	Cannot accept the playback start of the last-in program.
	LIFO	Plays the last-in program.
When playbacks of 2 programs with the same priority level are simultaneously started	FIFO	Plays the lower-numbered program.
	LIFO	Plays the higher-numbered program.

As for the broadcast priority levels, see p. 81.

The figure below shows operations of the FIFO and LIFO playbacks.

When playback of Program (P002) with the same priority is started during Program (P001) playback:

#### FIFO playback

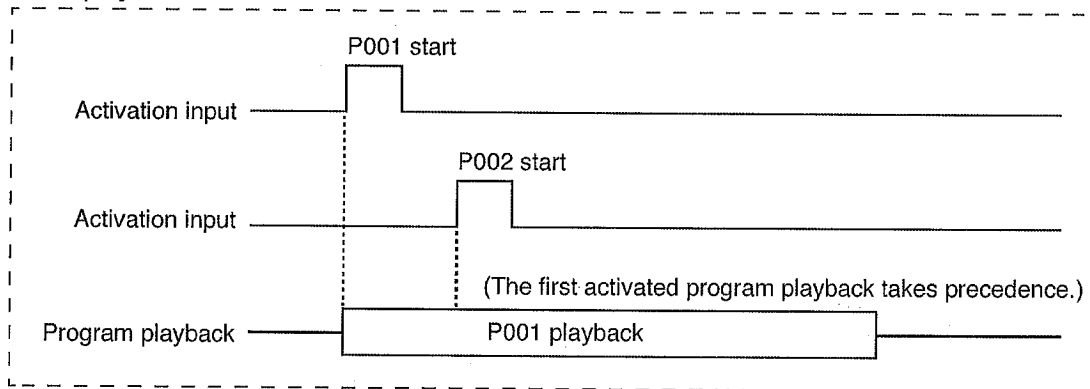

#### LIFO playback

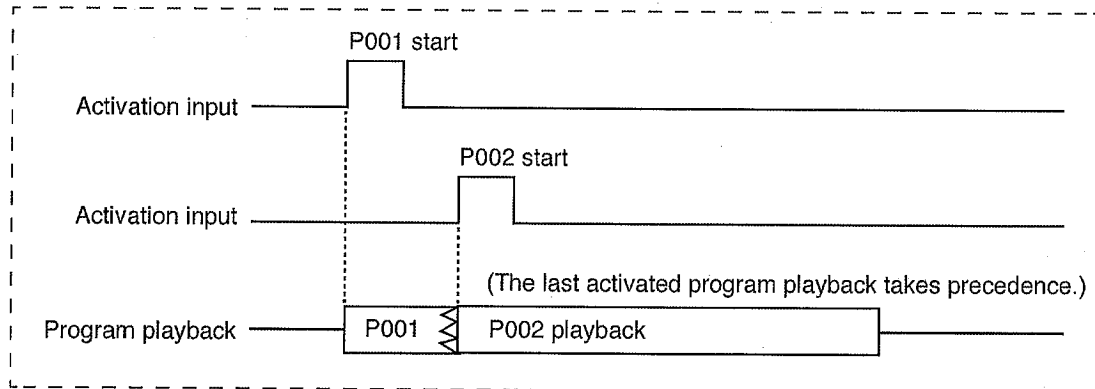

When playbacks of 2 programs with the same priority level are simultaneously started:

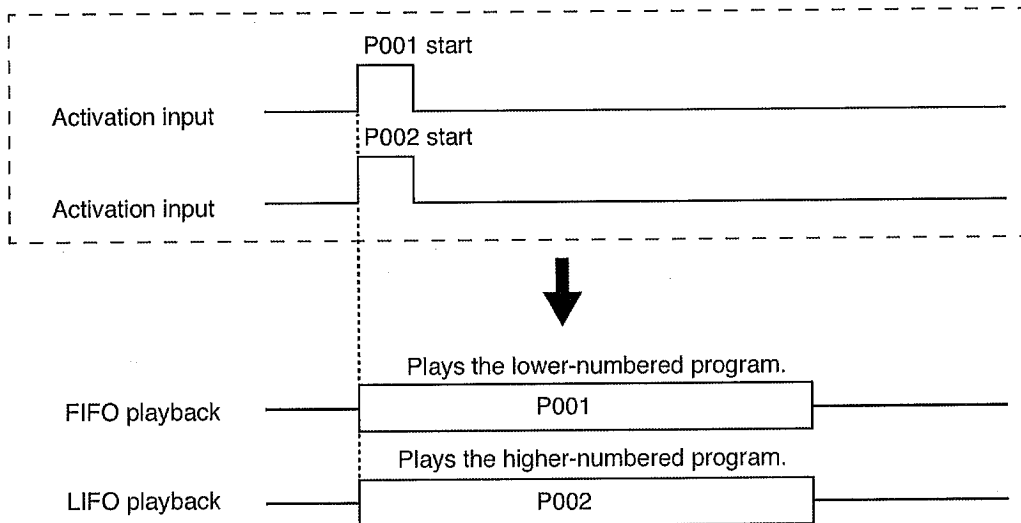

**[Sequential storage playback]**

The unit memorizes up to 16 activation inputs, then each playback is started in the order of input. The program playback order has no relation to the program priority level. Programs are played in the order of the activation signal input.

The figure below shows operations of the Sequential storage playback.

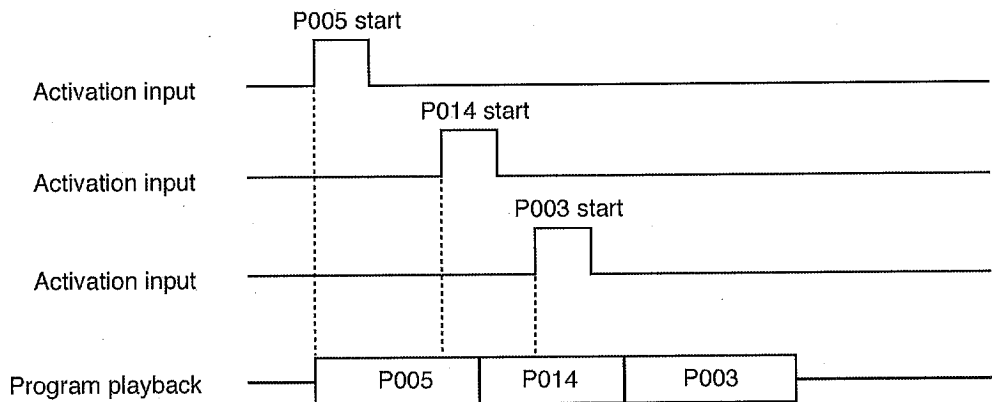

**Tip:** When 2 or more activation signals are simultaneously input, programs are played in the order of program number.

### 12.3.4. Forced stop and spontaneous stop of phrase playback

**Forced stop:** Stops the program currently being played when the Stop control input terminal is closed.

**Spontaneous stop of phrase playback:** Stops the program after the phrase in it currently being played has ended when the Stop control input terminal is closed.

#### [Operations of the Forced stop and the Spontaneous stop of phrase playback]

##### Forced stop

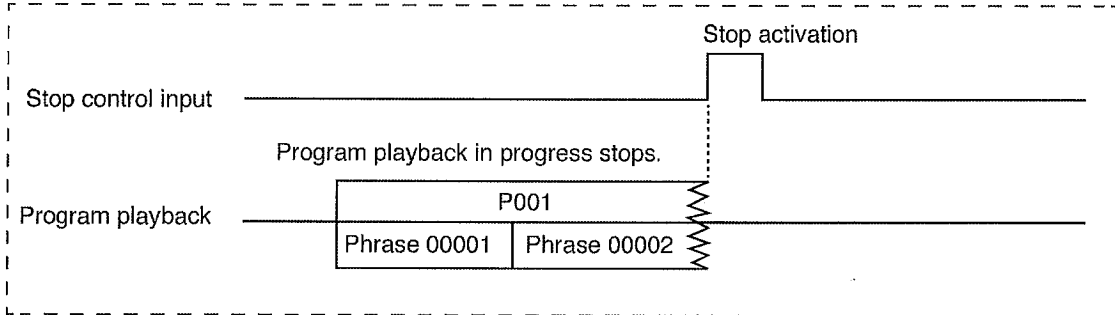

##### Spontaneous stop of phrase playback

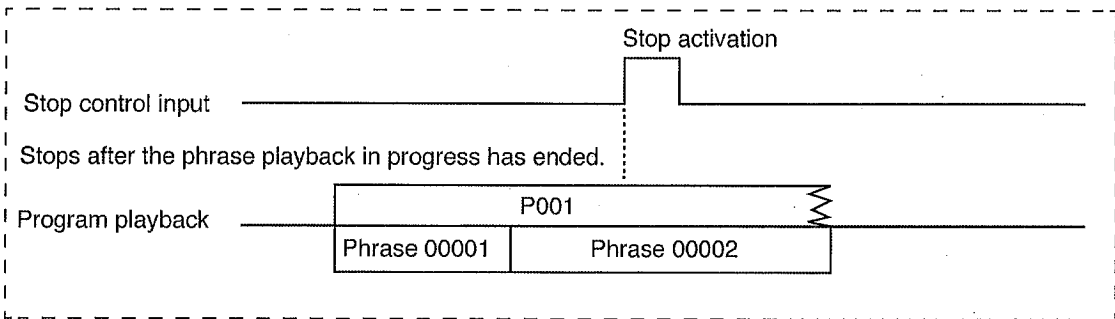

## 12.4. Details of the Activation Signals and Operations

### 12.4.1. Activation mode list

Control function	Activation target	Activation type	Operation	Contact input order*1	Reference page
Direct control	Playback	Pulse	FIFO (priority setting)	A	p. 39 (1)
			LIFO (priority setting)	A	p. 39 (2)
			Sequential storage	A	p. 40 (3)
		Level	FIFO (priority setting)	A	p. 41 (4)
			LIFO (priority setting)	A	p. 42 (5)
	Recording	Pulse	-	B	p. 42 (6)
		Level	-	B	p. 43 (7)
	Deletion/Clear	Pulse	-	B	p. 43 (8)
	Stop	Pulse	Forced stop	C	p. 43 (9)
			Spontaneous stop of phrase playback	C	p. 44 (10)
Binary control	Playback	Pulse	FIFO (priority setting)	D	p. 45 (11)
			LIFO (priority setting)	D	p. 46 (12)
			Sequential storage	D	p. 47 (13)
		Level	-	D	p. 48 (14)
	Recording	Pulse	-	D	p. 48 (15)
		Level	-	D	p. 49 (16)
	Delete/Clear	Pulse	-	D	p. 49 (17)
	Stop	Pulse	Forced stop	C	p. 50 (18)
			Spontaneous stop of phrase playback	C	p. 50 (19)
	Common to Direct and Binary controls*2	Emergency Playback	Pulse	-	C
Level			-	C	p. 62
R.E.M. Playback		Level	-	C	p. 63
Emergency Playback stop		Pulse	Forced stop	C	p. 62
			Spontaneous stop of phrase playback	C	p. 62

\*1 Shown below are Contact input order types by the external control.

A: Closes the Contact-activated input terminal.

B: Closes the Contact-activated input terminal while the control input terminal is being closed.

C: Closes the control input terminal.

D: Closes the control input terminal while the Contact-activated input terminal is being closed.

\*2 Operations are the same no matter which control function is selected.

#### Tip

Operation contents such as the program number being broadcast appear on the Status display during each operation executed by the external control.

12.4.2. Direct control function

[(1) Operation of FIFO (priority setting) playback by a Pulse signal input activation]

- Priority setting: When P001 is higher than P002

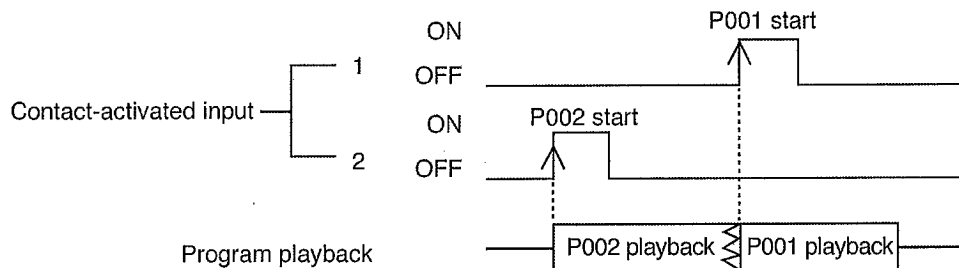

(Activation method)

Close the Contact-activated input terminal corresponding to the program number to be played.

(Operation description)

When P001 playback is activated during Program P002 playback, P001 is played preferentially.

- Priority setting: When P001 is lower than or equal to P002

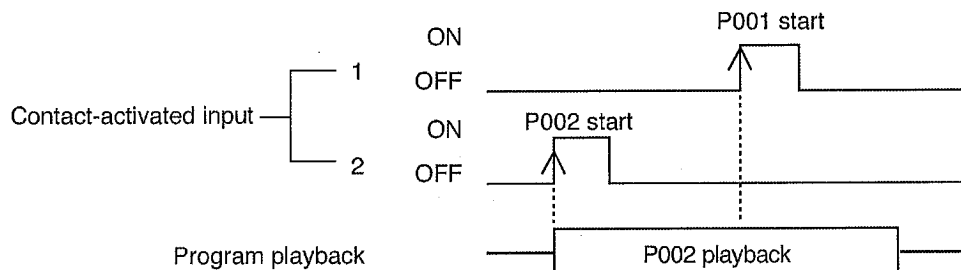

(Activation method)

Close the Contact-activated input terminal corresponding to the program number to be played.

(Operation description)

Even if P001 playback is activated during Program P002 playback, the last-in P001 start is ignored and the first activated P002 playback continues.

[(2) Operation of LIFO playback (priority setting) by a Pulse signal input activation]

- Priority setting: When P001 is higher than or equal to P002

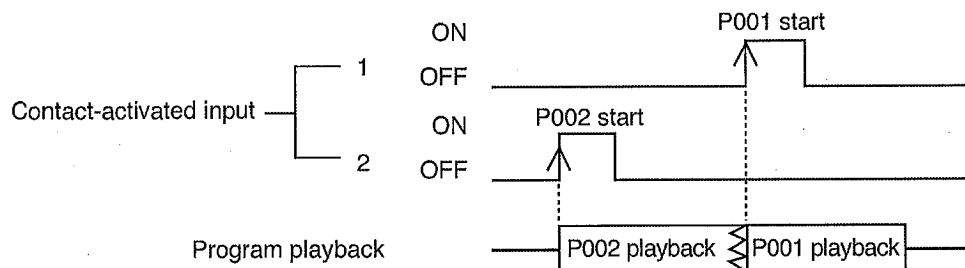

(Activation method)

Close the Contact-activated input terminal corresponding to the program number to be played.

(Operation description)

When P001 playback is activated during Program P002 playback, P001 is played preferentially.

Direct control

- Priority setting: When P001 is lower than P002

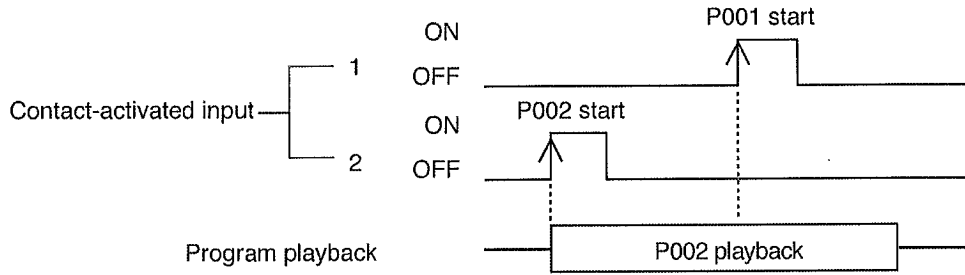

(Activation method)

Close the Contact-activated input terminal corresponding to the program number to be played.

(Operation description)

Even if P001 playback is activated during Program P002 playback, the last-in P001 start is ignored and the first activated P002 playback continues.

**[(3) Operation of Sequential storage playback by a Pulse signal input activation]**

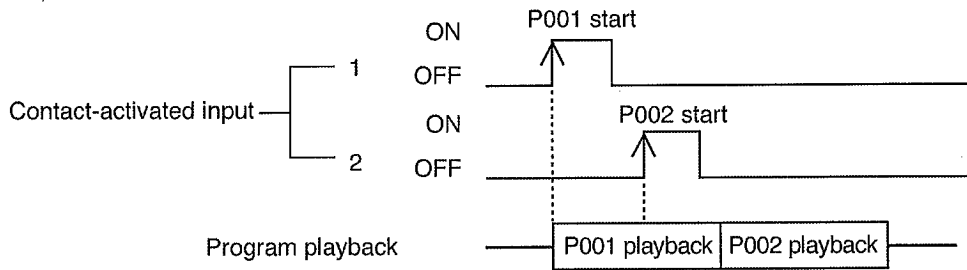

(Activation method)

Sequentially close the Contact-activated input terminal corresponding to the program number to be played.

(Operation description)

Up to 16 activation inputs can be stored. The program corresponding to each input is played in the order of entry.

In the example above, P001 playback and P002 playback start in order.

If the Contact-activated input terminal corresponding to the same program is closed multiple times, these activation inputs are stored by the same number of closures.

In this operation of Sequential storage playback, sequential playback is made regardless of the priority level assigned to the program.

- To stop program during playback  
Close the Stop control input terminal.

When there is a subsequent stored activation input, the next program will be automatically played.

Example: When activation inputs for P001 through P003 have been entered in sequence and when the Stop control input is entered during P002 playback

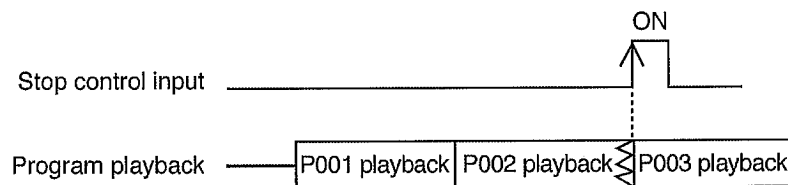

In the example above, P002 playback is interrupted, then the subsequent Program P003 playback will start.



- To clear the stored inputs  
Close the Delete/Clear control input terminal.  
The stored inputs are all cleared.

Example: When the activation inputs for P001 through P005 have been entered in sequence and when the stored inputs are cleared during P002 playback

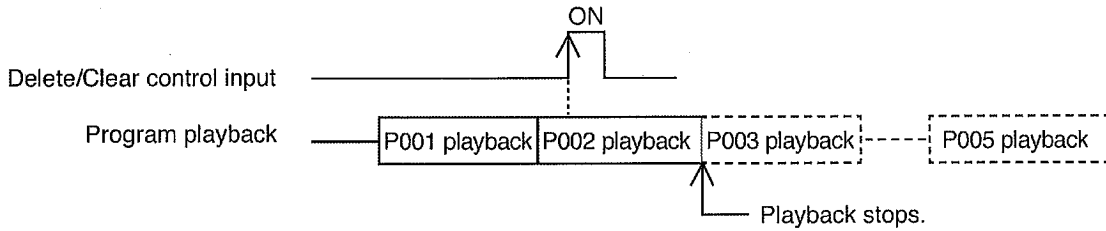

In the example above, playback stops when P002 playback is complete and no subsequent programs are played.

**[(4) Operation of FIFO playback (priority setting) by a Level signal input activation]**

- Priority setting: When P001 is higher than P002

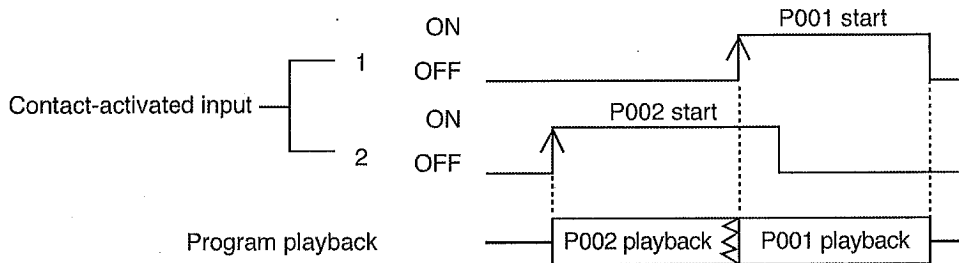

(Activation method)

Close the Contact-activated input terminal corresponding to the program number to be played.

(Operation description)

When P001 playback is activated during Program P002 playback, P001 is played preferentially.

- Priority setting: When P001 is lower than or equal to P002

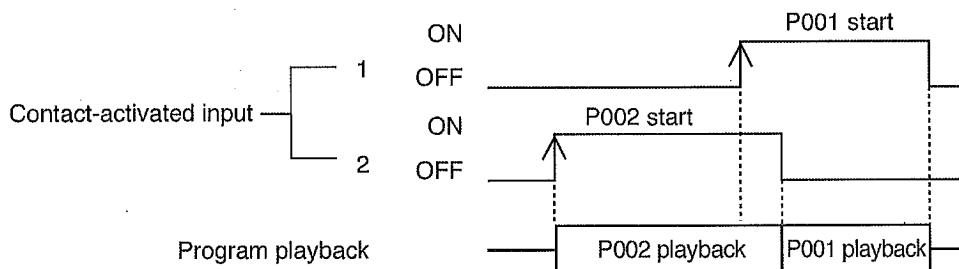

(Activation method)

Close the Contact-activated input terminal corresponding to the program number to be played.

(Operation description)

P002 playback continues even if P001 playback is activated during Program P002 playback.

**[(5) Operation of LIFO playback (priority setting) by a Level signal input activation]**

- Priority setting: When P001 is higher than or equal to P002

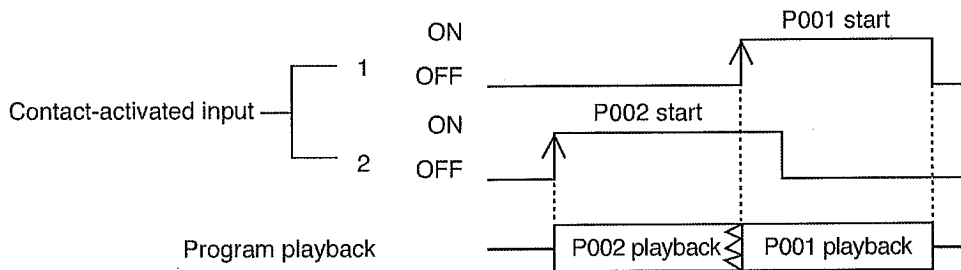

(Activation method)

Close the Contact-activated input terminal corresponding to the program number to be played.

(Operation description)

When P001 playback is activated during Program P002 playback, P001 is played preferentially.

- Priority setting: When P001 is lower than P002

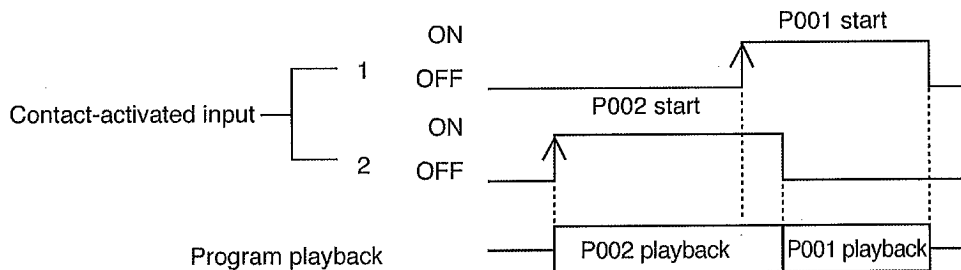

(Activation method)

Close the Contact-activated input terminal corresponding to the program number to be played.

(Operation description)

P002 playback continues even if P001 playback is activated during Program P002 playback.

**[(6) Recording operation by a Pulse signal input activation]**

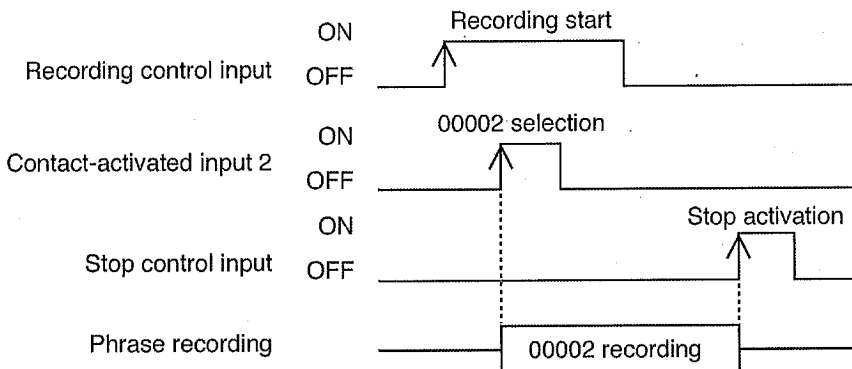

(Activation method)

Close the Contact-activated input terminal corresponding to the phrase number to be recorded while the Recording control input terminal is being closed.

(Operation description)

Audio source will be recorded to the Phrase No. 00002 when recording starts.

Recording stops when the Stop control input terminal is closed or the Start/Stop key is pressed.

Also, recording stops when the remaining recordable time reaches "0."

**Note**

You cannot perform any other operation until recording stops once started.

### [(7) Recording operation by a Level signal input activation]

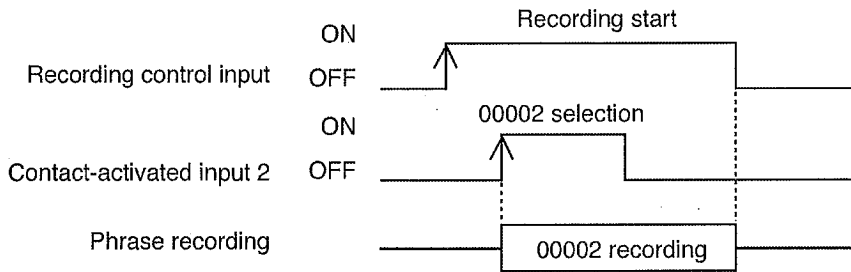

(Activation method)

Close the Contact-activated input terminal corresponding to the phrase number to be recorded while the Recording control input terminal is being closed.

(Operation description)

When recording starts, audio source will be recorded to the Phrase No. 00002 as long as the Recording control input terminal is closed.

Recording stops when the Recording control input terminal is opened.

Also, recording stops when the remaining recordable time reaches "0."

#### Note

You cannot perform any other operation until recording stops once started.

### [(8) Operation of delete/clear by a Pulse signal input activation]

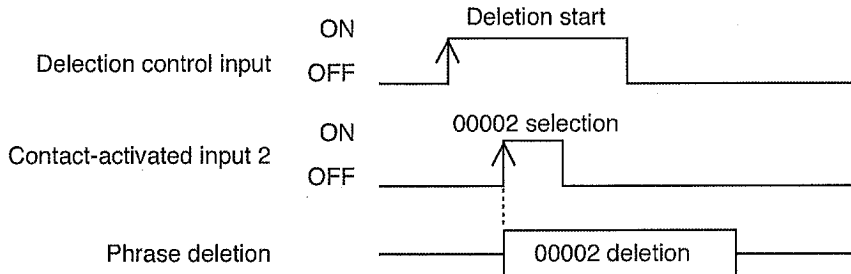

(Activation method)

Close the Contact-activated input terminal corresponding to the phrase number to be deleted while the Deletion control input terminal is being closed.

(Operation description)

Starting the deletion causes deletion of the Phrase No. 00002 to start. The operation automatically stops when the deletion has finished.

#### Note

Control input and key operation are disabled during deletion.

### [(9) Forced stop operation by a Pulse signal input activation]

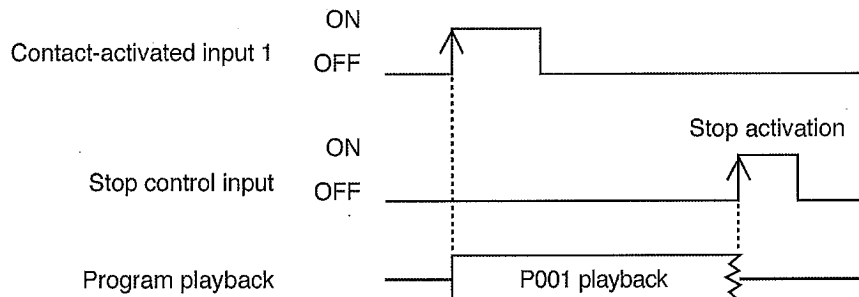

(Activation method)

Program playback currently in operation stops instantly when the Stop control input terminal is closed.

(Operation description)

P001 Playback starts by the activation input signal and stops instantly when the Stop control input terminal is closed during playback.

#### Note

Program playback cannot be started while the Stop control input terminal is being closed.

Program playback will not stop even if the Stop control input terminal is closed during the playback started by a Level signal input activation.

**[(10) Spontaneous stop operation of phrase playback by a Pulse signal input activation]**

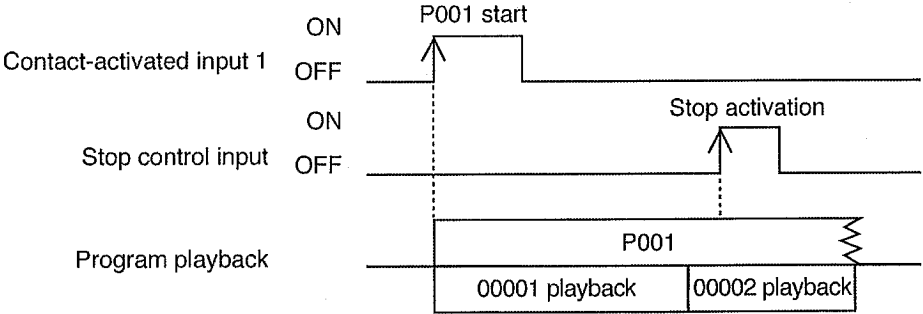

**(Activation method)**

When the Stop control input terminal is closed, program playback will stop after the phrase playback in the program currently being played reaches its end.

**(Operation description)**

P001 playback starts by the activation input signal. When the Stop control input terminal is closed during Phrase 00002 playback, program playback will stop after the phrase playback reaches its end.

**Note**

Program playback cannot be started while the Stop control input terminal is being closed. Program playback will not stop even if the Stop control input terminal is closed during the playback started by a Level signal input activation.

## 12.4.3. Binary control function

## [[11] Operation of FIFO (priority setting) playback by a Pulse signal input activation]

- Priority setting: When P002 is higher than P003

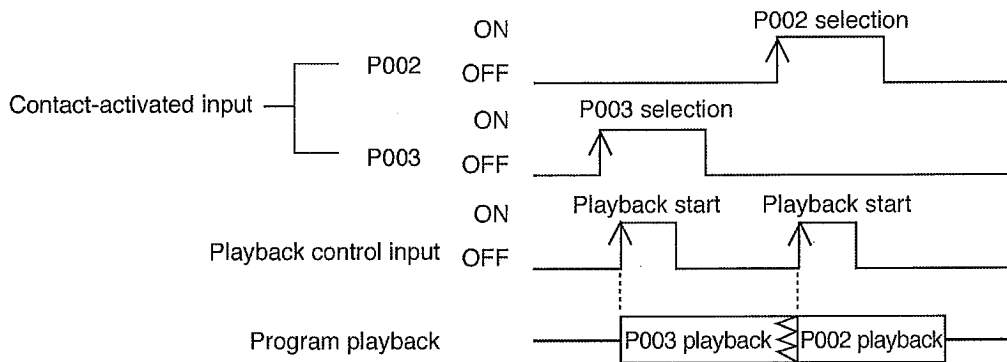

(Activation method)

Close the Playback control input terminal while the Contact-activated input terminal corresponding to the program number to be played is being closed.

(Operation description)

When P002 playback is activated during Program P003 playback, P002 is played preferentially.

- Priority setting: When P002 is lower than or equal to P003

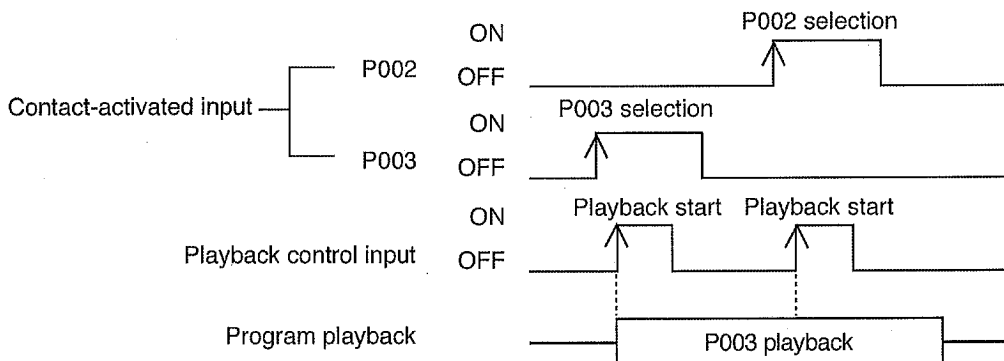

(Activation method)

Close the Playback control input terminal while the Contact-activated input terminal corresponding to the program number to be played is being closed.

(Operation description)

Even if P002 playback is activated during Program P003 playback, the last-in P002 start is ignored and the first activated P003 playback continues.

**[(12) Operation of LIFO playback (priority setting) by a Pulse signal input activation]**

- Priority setting: When P002 is higher than or equal to P003

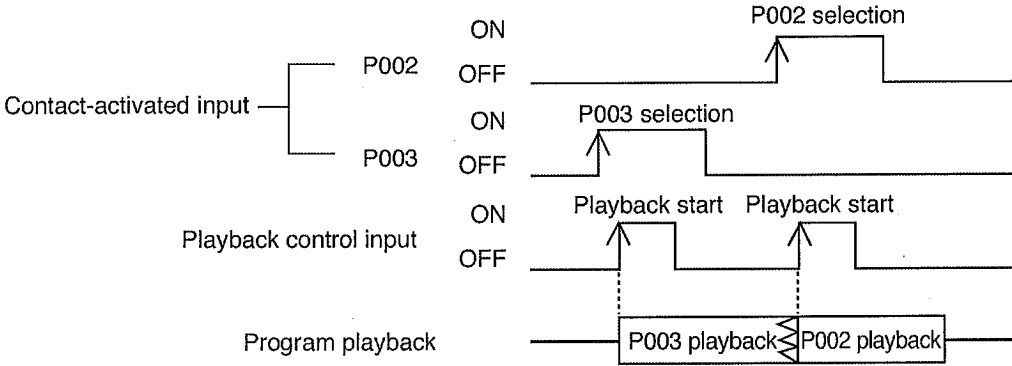

(Activation method)

Close the Playback control input terminal while the Contact-activated input terminal corresponding to the program number to be played is being closed.

(Operation description)

When P002 playback is activated during Program P003 playback, P002 is played preferentially.

- Priority setting: When P002 is lower than P003

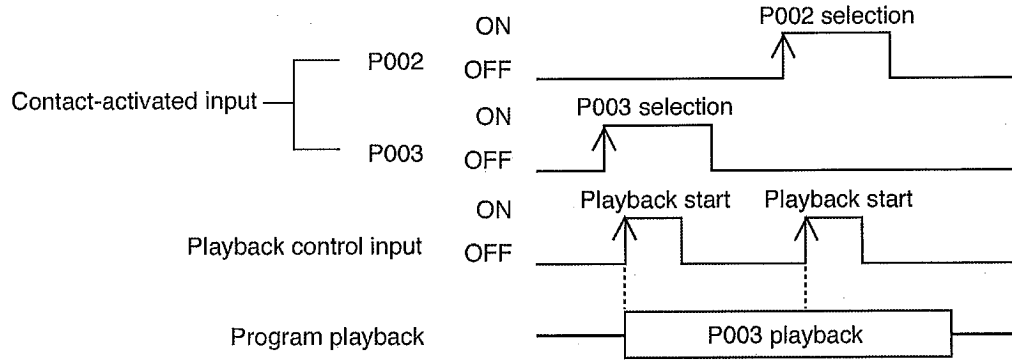

(Activation method)

Close the Playback control input terminal while the Contact-activated input terminal corresponding to the program number to be played is being closed.

(Operation description)

P003 playback continues even if P002 playback is activated during Program P003 playback.

**[(13) Operation of Sequential storage playback by a Pulse signal input activation]**

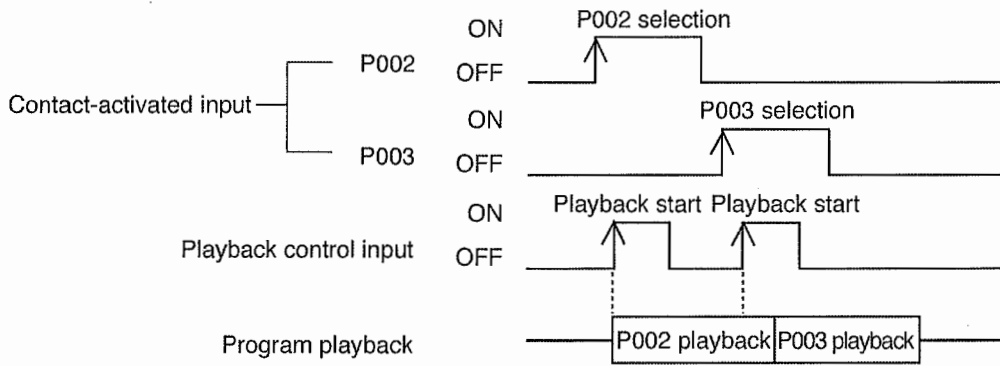

**(Activation method)**

Close the Playback control input terminal while the Contact-activated input terminal corresponding to the program number to be played is being closed.

Similarly, close the Contact-activated input terminal and Playback control input terminal in sequence.

**(Operation description)**

Up to 16 activation inputs can be stored. The program corresponding to each input is played in the order of entry. In the example above, P002 playback and P003 playback start in order.

If the Contact-activated input terminal corresponding to the same program is closed multiple times, these activation inputs are stored by the same number of closures.

In this operation of Sequential storage playback, sequential playback is made regardless of the priority level assigned to the program.

- To stop program during playback  
Close the Stop control input terminal.

When there is a subsequent stored activation input, the next program will be automatically played.

Example: When activation inputs for P001 through P003 have been entered in sequence and when the Stop control input is entered during P002 playback

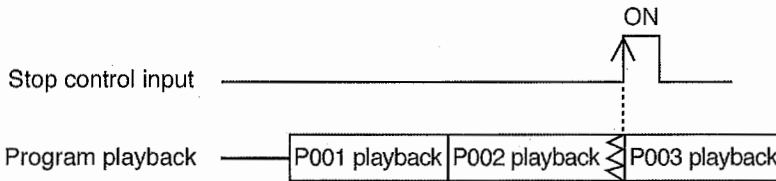

In the example above, P002 playback is interrupted, then the subsequent Program P003 playback will start.

- To clear the stored inputs  
Close the Delete/Clear control input terminal.  
The stored inputs are all cleared.

Example: When the activation inputs for P001 through P005 have been entered in sequence and when the stored inputs are cleared during P002 playback

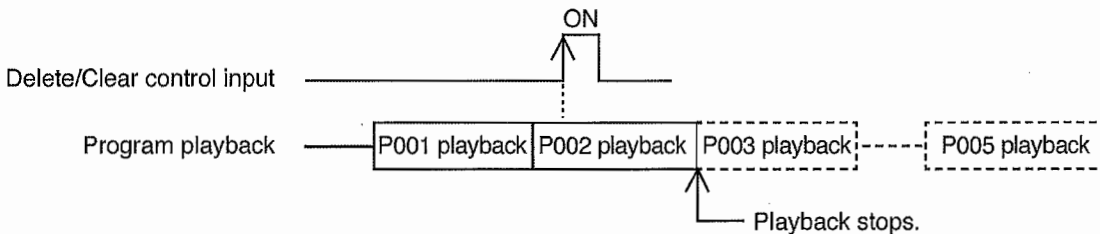

In the example above, playback stops when P002 playback is complete and no subsequent programs are played.

**[(14) Playback operation by a Level signal input activation]**

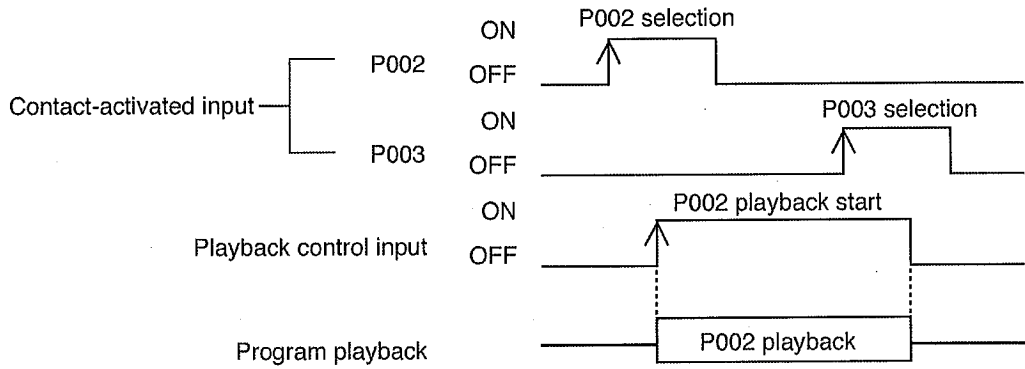

(Activation method)

Close the Playback control input terminal while the Contact-activated input terminal corresponding to the program number to be played is being closed.

(Operation description)

Even if the P003 is selected by the Contact-activated input terminal during P002 program playback, P003 will not be played regardless of the priority level, thereby keeping P002 playback as there is no Playback control input signal for starting P003 playback.

**[(15) Recording operation by a Pulse signal input activation]**

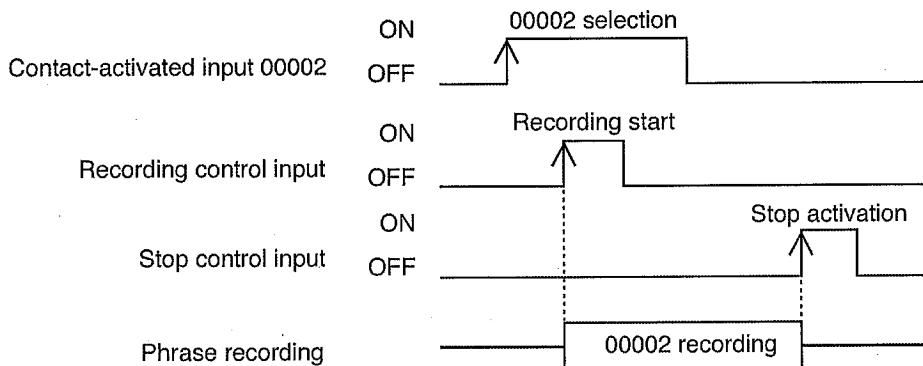

(Activation method)

Close the Recording control input terminal while the Contact-activated input terminal corresponding to the phrase number to be recorded is being closed.

(Operation description)

Audio source will be recorded to the Phrase No. 00002 when recording starts.

Recording stops when the Stop control input terminal is closed or the Start/Stop key is pressed.

Also, recording stops when the remaining recordable time reaches "0."

**Note**

You cannot perform any other operation until recording stops once started.



## [[16] Recording operation by a Level signal input activation]

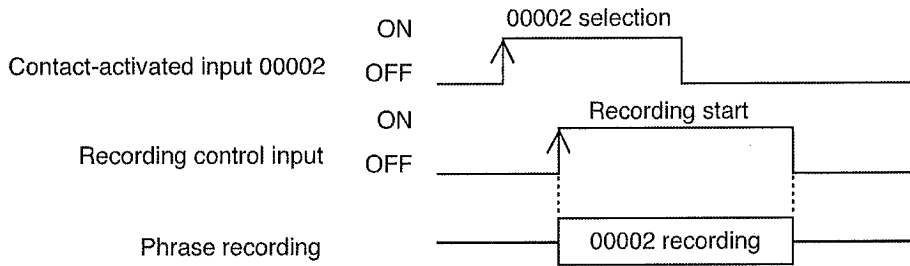

## (Activation method)

Close the Recording control input terminal while the Contact-activated input terminal corresponding to the phrase number to be recorded is being closed.

## (Operation description)

When recording starts, audio source will be recorded to the Phrase No. 00002 as long as the Recording control input terminal is closed.

Recording stops when the Recording control input terminal is opened.

Also, recording stops when the remaining recordable time reaches "0."

**Note**

You cannot perform any other operation until the Recording control input terminal is opened once recording has started.

## [[17] Operation of delete/clear by a Pulse signal input activation]

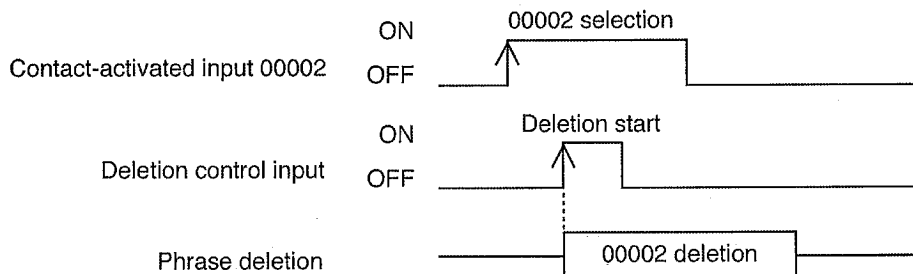

## (Activation method)

Close the Deletion control input terminal while the Contact-activated input terminal corresponding to the phrase number to be deleted is being closed.

## (Operation description)

Starting the deletion causes deletion of the Phrase No. 00002 to start. The operation automatically stops when the deletion has finished.

**Notes**

- Control input and key operation are disabled during deletion.
- Phrase 00001 is deleted simply by closing the Deletion control input terminal while the Contact-activated input terminal is not being closed.

**[(18) Forced stop operation by a Pulse signal input activation]**

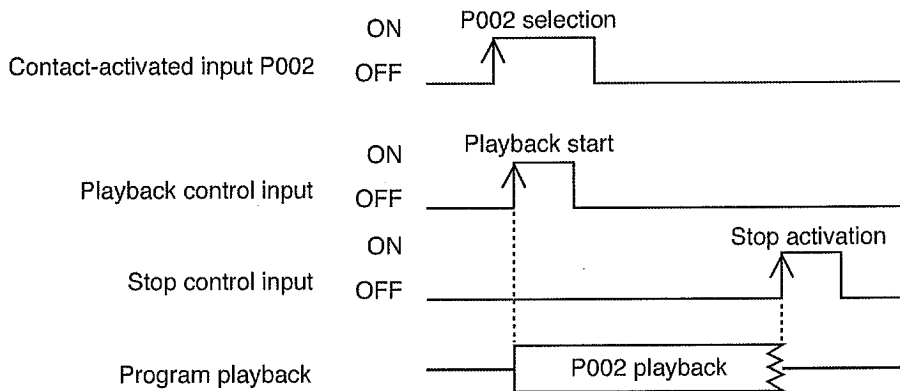

(Activation method)

Program playback currently in operation stops instantly when the Stop control input terminal is closed.

(Operation description)

P002 playback starts when the Playback control input terminal is closed after while the Contact-activated input terminal is being closed. Program playback stops instantly when the Stop control input terminal is closed during playback.

**Note**

Program playback cannot be started while the Stop control input terminal is being closed.

Program playback will not stop even if the Stop control input terminal is closed during the playback started by a Level signal input activation.

**[(19) Spontaneous stop operation of phrase playback by a Pulse signal input activation]**

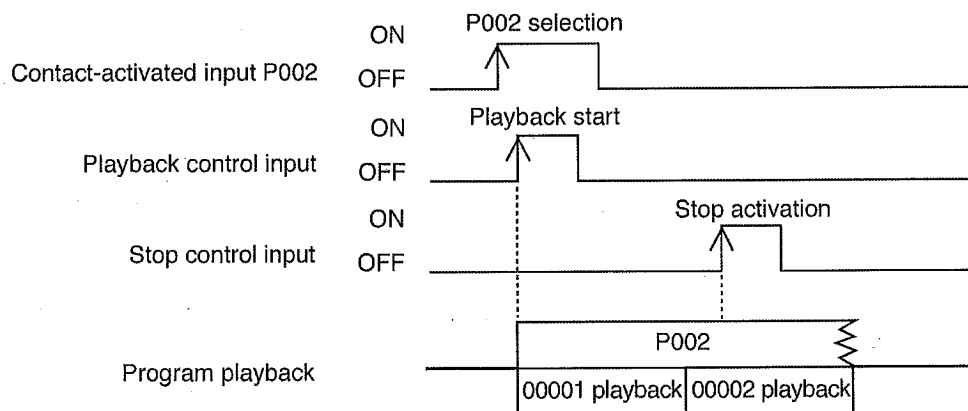

(Activation method)

When the Stop control input terminal is closed, program playback will stop after the phrase playback in the program currently being played reaches its end.

(Operation description)

P002 playback starts when the Playback control input terminal is closed while the Contact-activated input terminal is being closed. When the Stop control input terminal is closed during Phrase 00002 playback, program playback will stop after the phrase playback reaches its end.

**Note**

Program playback cannot be started while the Stop control input terminal is being closed.

Program playback will not stop even if the Stop control input terminal is closed during the playback started by a Level signal input activation.

## 13. TYPES OF EMERGENCY BROADCASTS

There are 2 types for the Emergency broadcasts, "Emergency playback" and "R.E.M. (Recording Endless Message) playback."

### **Emergency Playback (Prerecorded Playback)**

Allows the audio source for emergency playback prepared in advance to be broadcast preferentially in emergency situations. Priority is given to the emergency playback broadcast even during program playback or microphone announcement.

Output destination, repeat count, and repeat time can be preset using the EV-700 Setting software.

Audio source preparation and Emergency playback/stop can be made at the EV-700 unit or using the EV-700 Setting software.

This manual describes the method of operations performed at the EV-700 unit.

For the operation method performed using the EV-700 Setting software, see the EV-700 Setting software instruction manual.

### **R.E.M. Playback (Instant Recording Playback)**

Allows you to make a recording through one-touch operation in the event of an emergency and repeatedly broadcast the recorded contents immediately after recording.

Recording starts instantly by closing the rear-mounted Emergency recording control input terminals, and the recorded contents are played repeatedly when the terminals are opened.

Priority is given to the R.E.M. playback broadcast even during program playback or microphone announcement.

Output destination, repeat count, and repeat time can be preset using the EV-700 Setting software.

R.E.M. playback can be performed at the EV-700 unit or using the EV-700 Setting software.

This manual describes the method of operations performed at the EV-700 unit.

For the operation method performed using the EV-700 Setting software, see the EV-700 Setting software instruction manual.

### **Note**

Emergency playback cannot be made during broadcasts of R.E.M. playback. Likewise, R.E.M. playback cannot be made during Emergency playback.

### **Tip**

You can start recording for R.E.M. playback again during R.E.M. playback broadcast.

For the priority level settings, see p. 80.

## 14. EMERGENCY PLAYBACK (FRONT KEY OPERATION)

Explained here is a method of making advance preparation for Emergency broadcast through front key operation. (Such as recording of audio source for Emergency playback and audio source confirmation)  
 To make Emergency broadcast in the event of an emergency, use the Control input terminals or the EV-700 Setting software. (See p. 61, "EMERGENCY PLAYBACK (USING THE CONTROL INPUT TERMINALS)." and the EV-700 Setting software instruction manual.)

Before performing each front key operation described below, be sure to set only Switch 2 of the DIP switch on the front panel to the ON position. In this event, the "EMEr" (EMER) indication appears on the Status display. (See the figure below.)

This switch setting will place the unit in "Maintenance" mode.

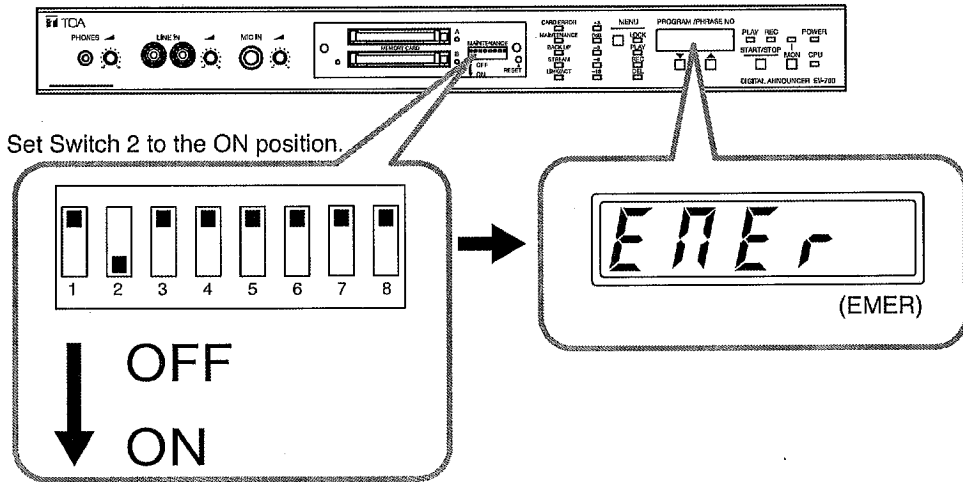

### 14.1. Recording Audio Sources

**Step 1.** Connect a microphone or audio source equipment such as a player to the EV-700.

**Step 2.** Set only Switch 2 to the ON position.  
 Confirm that the "EMEr" (EMER) indication appears on the Status display.

**Step 3.** Press the Menu key to select Recording mode.  
 Press the Menu key some times until the Recording mode indicator lights.  
 The "rEC" (REC) indication appears for about 1 second on the Status display, followed by the "EMEr" indication.

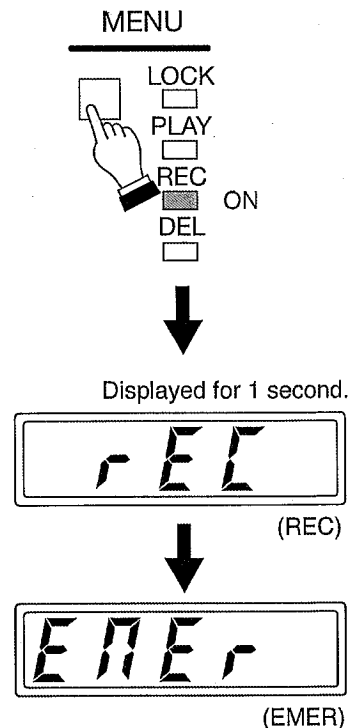

**Step 4.** Press the Start/Stop key.

The "rEAdy" (READY) indication appears on the Status display, then the unit will be placed in Recording standby mode.

The Recording indicator and the dot at the lower right corner of the Status display flash during Recording standby.



(READY) Flashing



START/STOP



**Note**

In this event, when the audio source has already been registered, the indication shown below appears for about 1 second on the Status display, then returns to "EMEr" indication.



(CAN'T)

To record an audio source in this state, delete the recorded audio source first, then start recording.

(See p. 59, "Deleting the Recorded Audio Sources.")

**Tip**

You can monitor the recorded contents only with headphones.

(See p. 58, "Confirming Audio Source Contents.")

**Step 5.** Adjust the sound volume of the sound source to record.

Adjust the sound volume of the sound source with the Microphone input volume control or Line input volume control while watching the level meter.

Take care so that "+3" LED of the level meter is not constantly lighting.

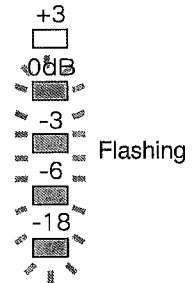

**Tips**

- When input signals are fed to both the Microphone and Line inputs, you can set which input to take precedence using the EV-700 Setting software. The input with the higher broadcast priority (see p. 81) assigned takes precedence.
- You can monitor the content of the sound source to be recorded using headphones.

Front panel

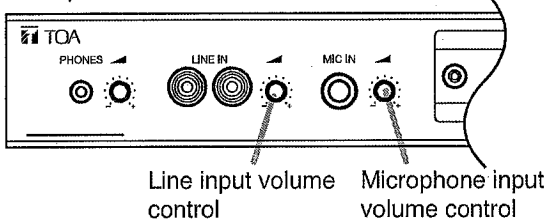

**Step 6.** Press the Start/Stop key again. Recording will start after 3 seconds. Time (seconds) till recording start is indicated by the countdown signs from "3" to "1" on the Status display.



PLAY REC  
  Flashing  
 START/STOP

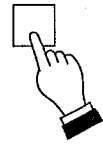

Displayed for 1 second.



PLAY REC  
  ON  
 START/STOP

When recording starts, the Recording indicator lights and the "REC" (REC) indication appears for about 1 second on the Status display, followed by the "EMER" (EMER) indication.



(REC)

(EMER)

**Step 7.** Speak into the microphone or play the sound source by a player.

[To disable each key operation]

Press the Menu key to place the unit in Lock mode.

The Lock mode indicator lights. Key operation except the Menu key is disabled, preventing accidental wrong operation.

To cancel Lock mode, press the Menu key again.

**Tip**

The unit is automatically placed in Lock mode after 5 minutes from recording start.

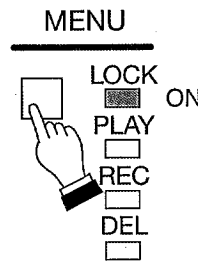

**Step 8.** Press the Start/Stop key to stop recording. The Recording indicator goes off.

PLAY REC  
   
 START/STOP

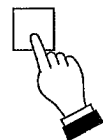

**Step 9.** When recording of audio source is complete, return Switch 2 to the OFF position.

**Tip**

When you finish all operations, it is recommended that you place the unit in Lock mode to prevent accidental operation. (See p. 27, "Disabling Each Key Operation on the Front Panel (Lock Mode).")

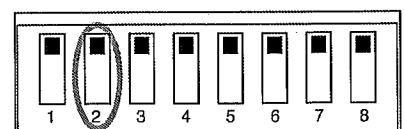

## 14.2. Making Emergency Playback

### Note

When Emergency playback is made following procedures below, note that the Emergency playback busy signal is not output.

**Step 1.** Set only Switch 2 to the ON position.  
Confirm that the "EMER" (EMER) indication appears on the Status display.

**Step 2.** Press the Menu key to select Play mode.  
Press the Menu key several times until the Play mode indicator lights.  
The "PLAY" indication appears for about 1 second on the Status display, followed by the "EMER" indication.

### Tip

You can monitor the registered recorded contents only with headphones prior to playback. (See p. 58, "Confirming Audio Source Contents.")

**Step 3.** Press the Start/Stop key.  
Emergency playback starts.  
The Play indicator lights during playback, and the signal level is displayed in the level meter.

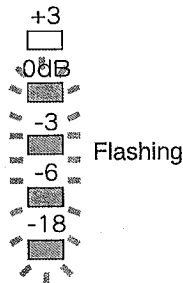

### Tip

You can stop the playback partway. (See p. 57, "Stopping Emergency Playback.")

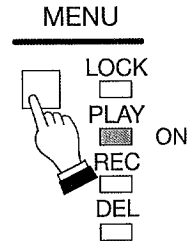
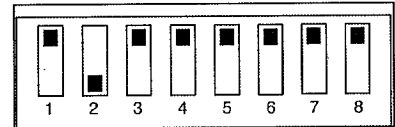

Displayed for 1 second.



(PLAY)



(EMER)



[To disable each key operation]

Press the Menu key to place the unit in Lock mode.

The Lock mode indicator lights.

Key operation except the Menu key is disabled, preventing accidental wrong operation.

To cancel Lock mode, press the Menu key again.

**Tip**

The unit is automatically placed in Lock mode after 5 minutes from playback start.

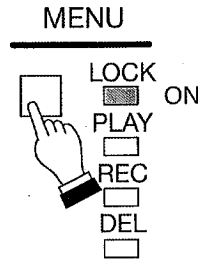

**Step 4.** When Emergency playback is complete, return Switch 2 to the OFF position.

**Tip**

When you finish all operations, it is recommended that you place the unit in Lock mode to prevent accidental operation. (See p. 27, "Disabling Each Key Operation on the Front Panel (Lock Mode).")

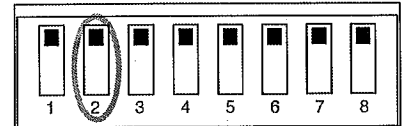



### 14.3. Stopping Emergency Playback

You can stop Emergency playback following the procedures below even if it is made using any method of the EV-700 Setting software, Control input, or front-key operation.

#### Tip

When Emergency playback is under way using the EV-700 Setting software or control input, it is possible to stop Emergency playback even if the DIP switch for maintenance is not operated.

Emergency playback stops by opening the Emergency playback control input terminals when Level signal input activation is set for Emergency playback. (See p. 62.)

- Step 1.** Press the Menu key to select Play mode.  
Press the Menu key several times until the Play mode indicator lights.

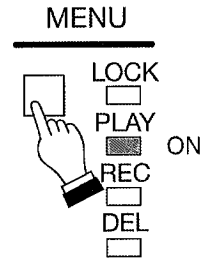

- Step 2.** Press the Start/Stop key.  
Emergency playback stops, and the Play indicator goes off.

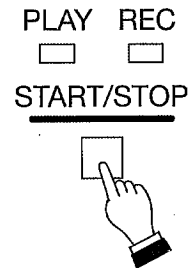

- Step 3.** (Only when Switch 2 is set to the ON position).  
When Emergency playback stops, return Switch 2 to the OFF position.

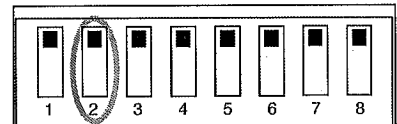

## 14.4. Confirming Audio Source Contents

When performing recording (See p. 52.), playback (See p. 55.), or deletion (See p. 59.) of the audio source for emergency playback, you can confirm the audio source contents.

**Step 1.** Press the Monitor key while the playback mode, recording mode, or deletion mode for the emergency playback is being selected.  
The monitor indicator lights and you can monitor the audio source for Emergency playback on the headphones.

**Tip**

Monitor sound is not output from the Line output terminals 1 and 2.

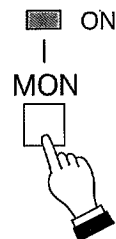

**Step 2.** To finish monitoring partway, press the Monitor key again.  
The monitor indicator goes off and monitoring terminates.

**Tip**

Even if this step is skipped, monitoring automatically terminates when the audio source playback is complete.

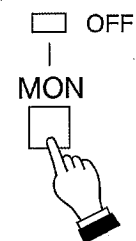

## 14.5. Deleting the Recorded Audio Sources

**Step 1.** Set only Switch 2 to the ON position.  
Confirm that the "EMEr" (EMER) indication appears on the Status display.

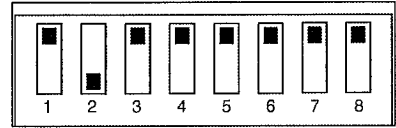

**Step 2.** Press the Menu key to select Delete mode.  
Press the Menu key some times until the Delete mode indicator lights.  
The "dEL" (DEL) indication appears for about 1 second on the Status display, followed by the "EMEr" indication.

**Tip**

You can monitor the recorded contents to be deleted only with headphones before you delete them. (See p. 58, "Confirming Audio Source Contents.")

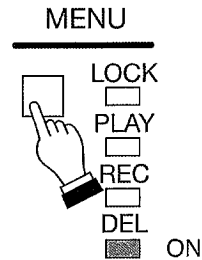

Displayed for 1 second.



(DEL)



(EMER)

**Step 3.** Press the Start/Stop key.  
The "rEAdy" (READY) indication appears on the Status display, then the unit will be placed in Delete standby mode.  
The dot at the lower right corner of the Status display flashes during Delete standby.

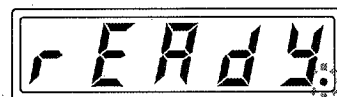

(READY)

Flashing

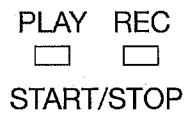

**Step 4.** Press the Start/Stop key again.  
 The audio source for Emergency playback is deleted.  
 The "dEL" (DEL) indication appears on the status display, followed by the flashing "EMEr" indication during deletion.

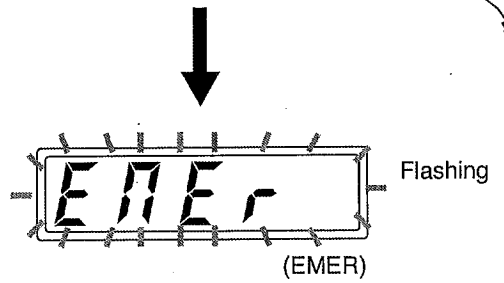
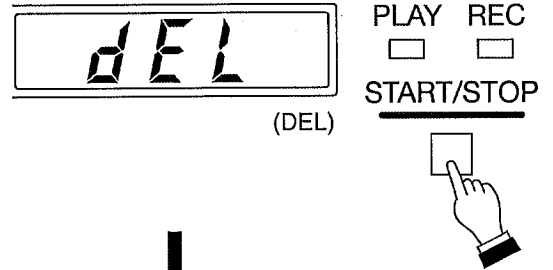

Hyphens appear when the deletion is complete, then the display's indication changes to "EMEr."

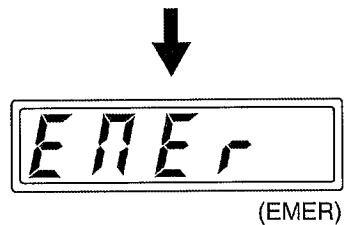
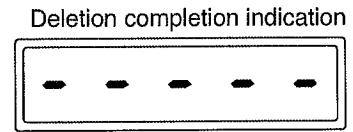

**Step 5.** When you finish checking audio source contents, return Switch 2 to the OFF position.

**Tip**  
 When you finish all operations, it is recommended that you place the unit in Lock mode to prevent accidental operation. (See p. 27, "Disabling Each Key Operation on the Front Panel (Lock Mode).")



## 15. EMERGENCY PLAYBACK (USING THE CONTROL INPUT TERMINALS)

You can start or stop Emergency playback using each control input terminal in the rear-mounted Input/Output terminal block.

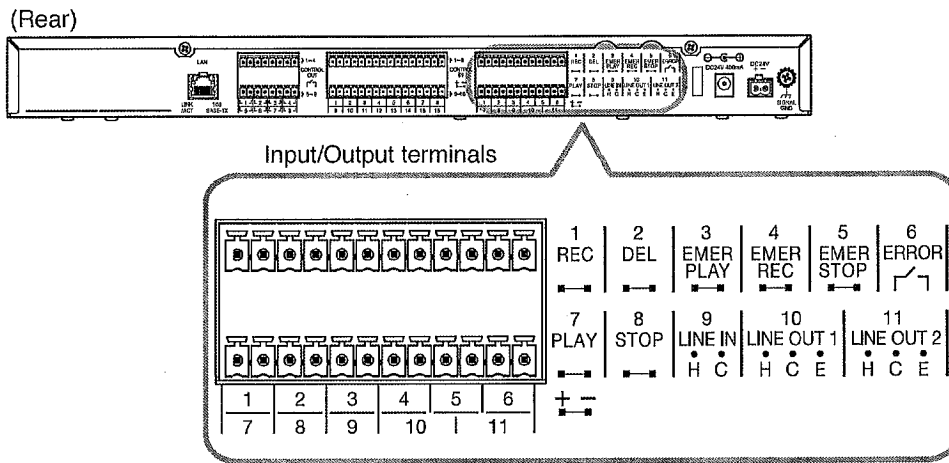

### 15.1. Making Emergency Playback

#### 15.1.1. When Pulse signal input activation is selected for the Emergency playback start setting

**Tip:** For details of operations, see p. 48, "Recording operation by a Pulse signal input activation."

**Step:** Close the Emergency playback control input terminals (Terminal No. 3).  
Emergency playback will start.  
Emergency playback will stop automatically after it is repeated by the number of times or for the period of time, both preset using the EV-700 Setting software.

#### Tips

- Emergency playback will automatically stop after it is repeated by the set number of times even if you continue to close the Emergency playback control input terminals after Emergency playback has started. (See p. 33, "Pulse signal input activation and Level signal input activation.")
- For the method to stop Emergency playback in such cases that the repeat count is set to "Infinite" (continuance), see p. 57, "Stopping Emergency Playback."

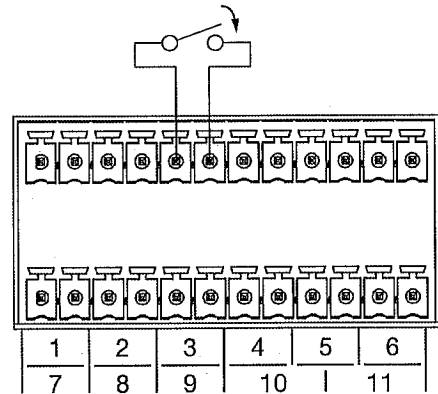

### 15.1.2. When Level signal input activation is selected for the Emergency playback start setting

**Step 1.** Close the Emergency playback control input terminals (Terminal No. 3).  
Emergency playback will start.  
Emergency playback continues as long as the Emergency playback control input terminals are closed.

**Step 2.** Open the Emergency playback control input terminals (Terminal No. 3).  
Emergency playback will stop.

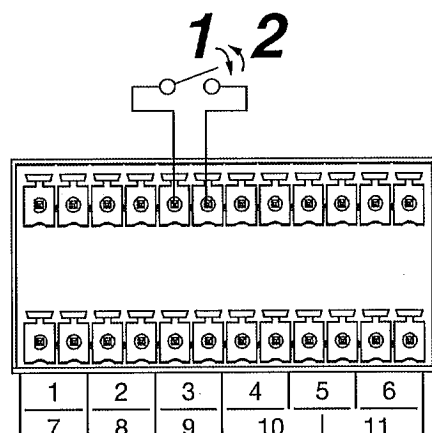

## 15.2. Stopping Emergency Playback

### 15.2.1. When Pulse signal input activation is selected for Emergency playback start setting

**Step:** Close the Emergency stop control input terminals (Terminal No. 5).  
Emergency playback will stop.

**Tip**

Playback can be stopped by the following 2 ways depending on the Emergency stop activation setting.

**[When set to the Forced stop]**

Emergency playback instantly stops.

**[When set to the Spontaneous stop of phrase playback]**

Emergency playback stops after the audio source of Emergency playback in progress is played to the end.

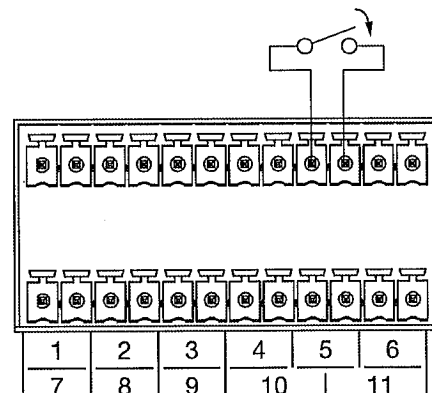

### 15.2.2. When Level signal input activation is selected for the Emergency playback start setting

**Step:** Open the Emergency playback control input terminals.

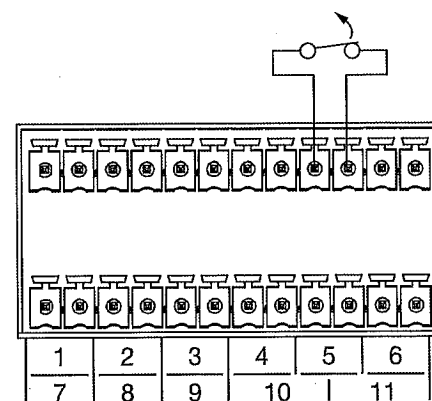

## 16. R.E.M. PLAYBACK

R.E.M. (Recording Endless Message) playback function is a function that allows you to make a recording through one-touch operation in the event of an emergency and repeatedly broadcast the recorded contents immediately after recording.

Recording starts instantly by closing the rear-mounted Emergency recording control input terminals, and the recorded contents are repeatedly played when the terminals are opened.

Output destination, repeat count, and repeat time can be preset using the EV-700 Setting software.

### 16.1. Repetitive Operation of R.E.M. Playback

[Operation when the repeat count is set to "0"]

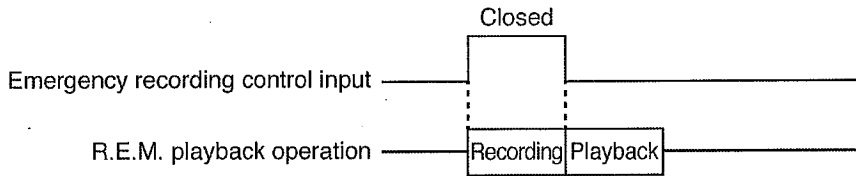

[Operation when the repeat count is set to "1"]

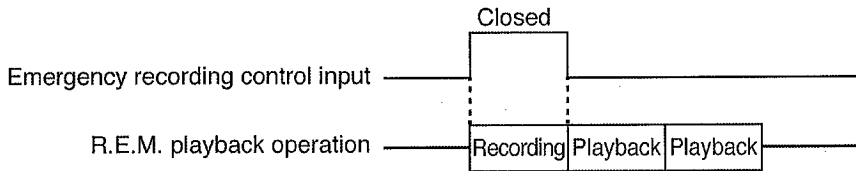

[Operation to stop playback by the Emergency stop control input when the repeat count is set to infinite (continuance)]

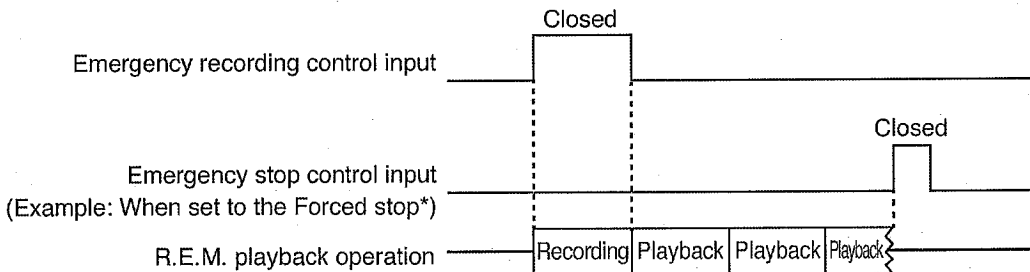

\* When set to the Spontaneous stop of phrase playback, Emergency playback stops after the audio source of R.E.M. playback in progress is played to the end.

[Operation when the repeat count is set to "Infinite" (continuance) and the repeat time to 5 minutes]

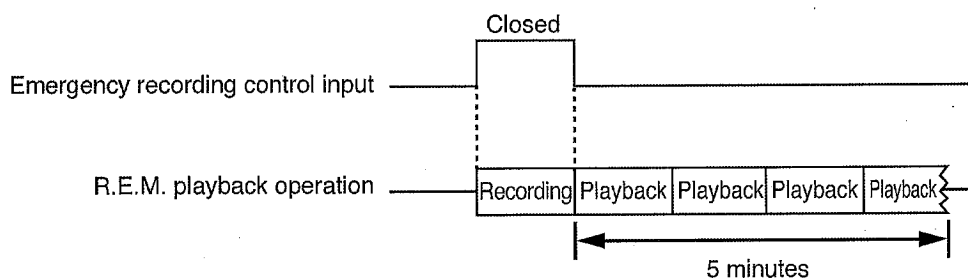

### 16.1.1. Making R.E.M. playback

Prepare for recording in advance by connecting a recording microphone to the front-mounted Microphone input terminal and a recording switch to the Emergency recording control input terminals (Terminal No. 4) in the rear-mounted Input/Output terminal block.

Adjust the Microphone input volume control to an appropriate broadcast volume.

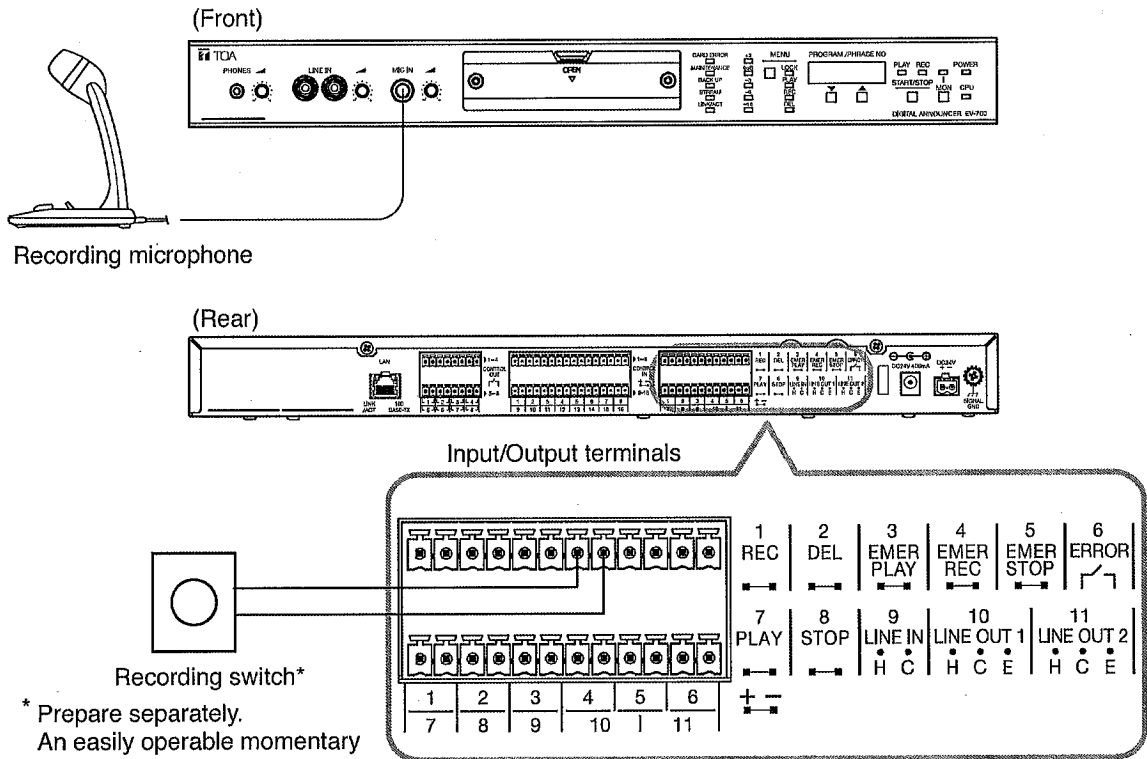

\* Prepare separately.  
An easily operable momentary switch (a switch that outputs a make signal while it is pressed) is convenient for this use.

#### Step 1. Press a recording switch.

The "EMER" (EMER) indication appears on the Status display. This indication remains ON during R.E.M. playback.

#### Step 2. Speak announcements into the microphone while pressing the switch.

#### Step 3. Release the switch.

Announcements recorded in Step 2 will be played. Playback will stop automatically after it is repeated by the preset number of times. You can also make a setting so that playback is repeated until it is stopped manually or by Emergency stop control input. (See the separate EV-700 Setting software instruction manual.)

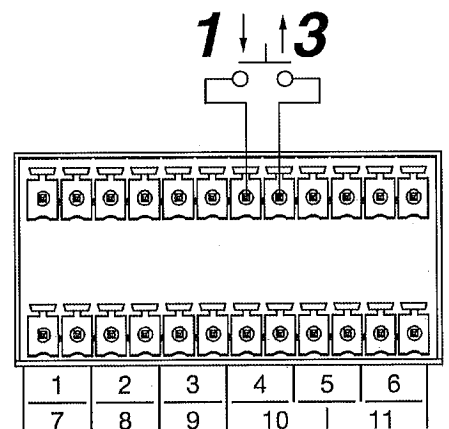

#### Tips

- Operation from recording to playback can be resumed if the recording switch is pressed once again while R.E.M. playback is being broadcast or after it is stopped. In this case, the previously recorded contents will be overwritten.
- Sound during recording of R.E.M. playback is not output (broadcast). It will be broadcast when playback is started after recording.
- Emergency broadcast is disabled while the Maintenance indicator is lighting when the DIP switch for maintenance has been set to the ON position. (Except when making Emergency playback manually)
- See p. 57, "Stopping Emergency Playback." for the method to manually stop R.E.M. playback. See p. 62, "Stopping Emergency Playback." for the method to stop R.E.M. playback by way of the Emergency stop control input.
- R.E.M. playback can be made using the sound source of the Line input instead of that of Mic input. When both the Microphone input and Line input enter at the same time, use the EV-700 Setting software to set which input takes precedence.



## 16.2. Operation and Setting at the Time of Emergency Broadcast

- When the emergency broadcast is initiated, the program playback in operation is stopped, allowing the emergency broadcast to take precedence.
- The EV-700 returns to the Lock mode after the emergency broadcast is stopped.
- Emergency broadcast is disabled while the Maintenance indicator is lighting. (Except when making emergency playback manually)

[Emergency broadcast setting contents list]

	Emergency playback		R.E.M. playback	
	Setting range	Factory-preset setting	Setting range	Factory-preset setting
Repeat count	0 to 127 times, infinite	Infinite	0 to 127 times, infinite	Infinite
Repeat time	5 to 120 minutes (in 5-minute units), infinite	Infinite	5 to 120 minutes (in 5-minute units), infinite	Infinite
Repeat interval	0 to 50 seconds (in 10-second units), 1 to 99 minutes (in 1-minute units)	0 second	0 to 50 seconds (in 10-second units), 1 to 99 minutes (in 1-minute units)	0 second
Busy output during interval	ON/OFF	ON	ON/OFF	ON
Priority level	1	1	1	1
Emergency playback busy output destination	Contact control output terminals 1 – 8	Contact control output terminals 1, 2	Contact control output terminals 1 – 8	Contact control output terminals 1, 2
R.E.M. busy output destination (See p. 86.)	–	–	Contact control output 1 – 8	None
Output destination	Line output 1, Line output 2	Line output 1, Line output 2	Line output 1, Line output 2	Line output 1, Line output 2
Program sound volume	0 – 10	10	0 – 10	10
AGC	ON/OFF	ON	ON/OFF	ON

## 17. PLAYBACK SYSTEMS

Playback system refers to the broadcasting way of phrases and programs.

Settings for the repeat playback of program or the phrase playback at regular intervals can be performed by selecting playback system.

Select the playback system from Program playback, Step playback, All phrases playback, or Chime playback for each program.

### Program playback

Stops after playing the phrases registered in a program in the order of the Step numbers.

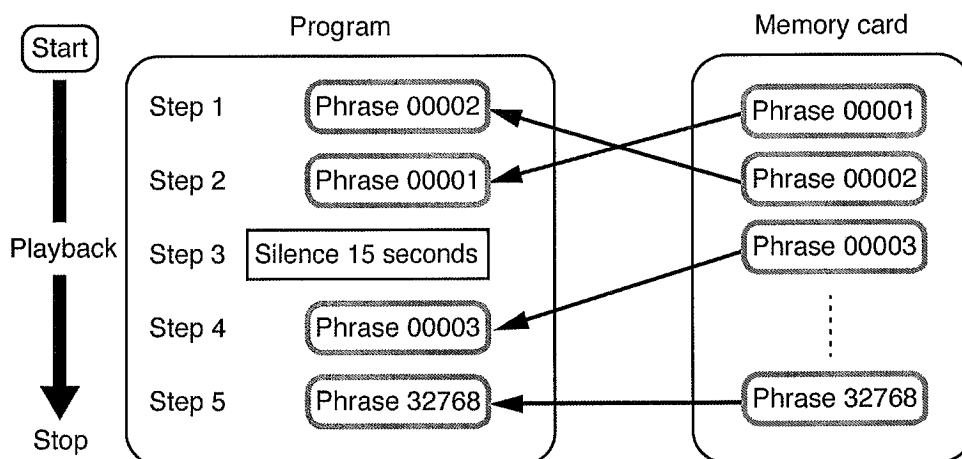

It can also repeat playbacks by setting the items shown below.

Setting item	Setting content
Repeat count <sup>*1</sup>	0 <sup>*2</sup> to 127 times, ∞
Repeat interval <sup>*3</sup>	0 to 99 minutes <sup>*4</sup>

<sup>\*1</sup> Playback stops after it is repeated by the set number of times.

<sup>\*2</sup> When repeat count is set to "0," playback is made only once, then stops. (Playback is not repeated.)

<sup>\*3</sup> A period of time from when the last step playback in a program ends until the first step playback resumes. Also, Busy output ON/OFF setting during repeat interval can be set.

<sup>\*4</sup> Intervals can be set in unit of time as follows.

Less than 1 minute: In 10-second units

1 minute or more: In 1-minute units

[Operation when playback is repeated]

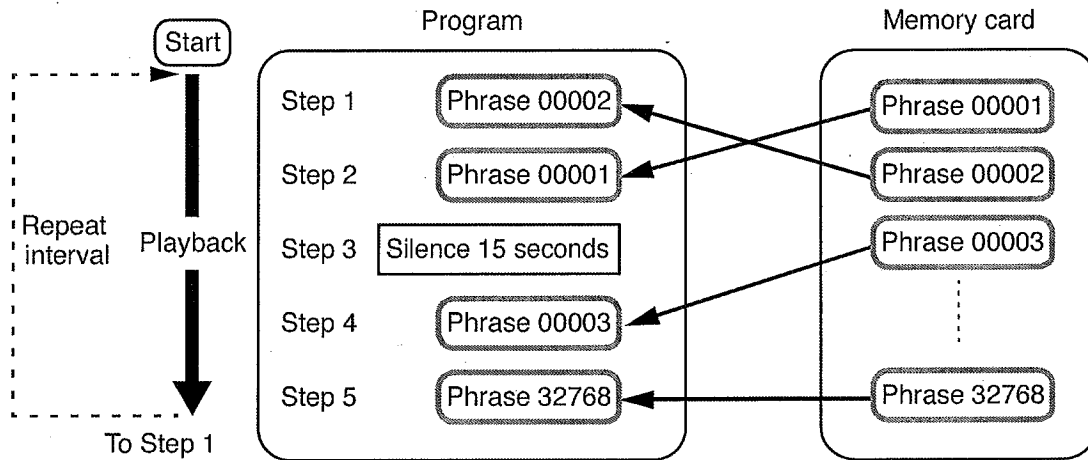

**Note:** Plays according to the set repeat count and repeat interval.

- Tips**
- Prerecorded audio files are factory-preset as follows: Repeat count is "0" (No repeat) and repeat interval "0."
  - To stop playback partway, perform any of the following operations: Pressing the Start/Stop key (See p. 21.), Closing the Stop control input terminals (See p. 33.), and Using the EV-700 Setting software. (See the EV-700 Setting software instruction manual.)

## Step playback

Plays the phrases entered into the program one by one in the order of Steps by each activation. Once you set the interval (phrase interval), phrases will be played at a fixed interval by one-time activation. Operation differs depending on whether Interval is set to OFF or in the range of 10 seconds to 99 minutes.

### [When the Interval is set to "OFF"]

- Playback stops after a single phrase playback is complete, and resumes from the phrase of the next step when the activation is triggered again.
- When playback of the last phrase is complete, playback starts from the first step of the program by the next activation.
- When stopping the playback by any of the following operations, it starts from the next step if the next activation is triggered: Pressing the Start/Stop key (See p. 21.), Closing the Stop control input terminals (See p. 33.), and Using the EV-700 Setting software. (See the EV-700 Setting software instruction manual.)
- Playback will start from the first step in the following cases even if it is played partway through a program.
  - When the first program is activated again while the second program activated during first program playback is being played
  - When the original program is activated again after power has been turned off during playback and on
- Monitor playback of the current Step will start when the Monitor key is pressed. Step proceeds to the next one when monitor playback of that step is complete.

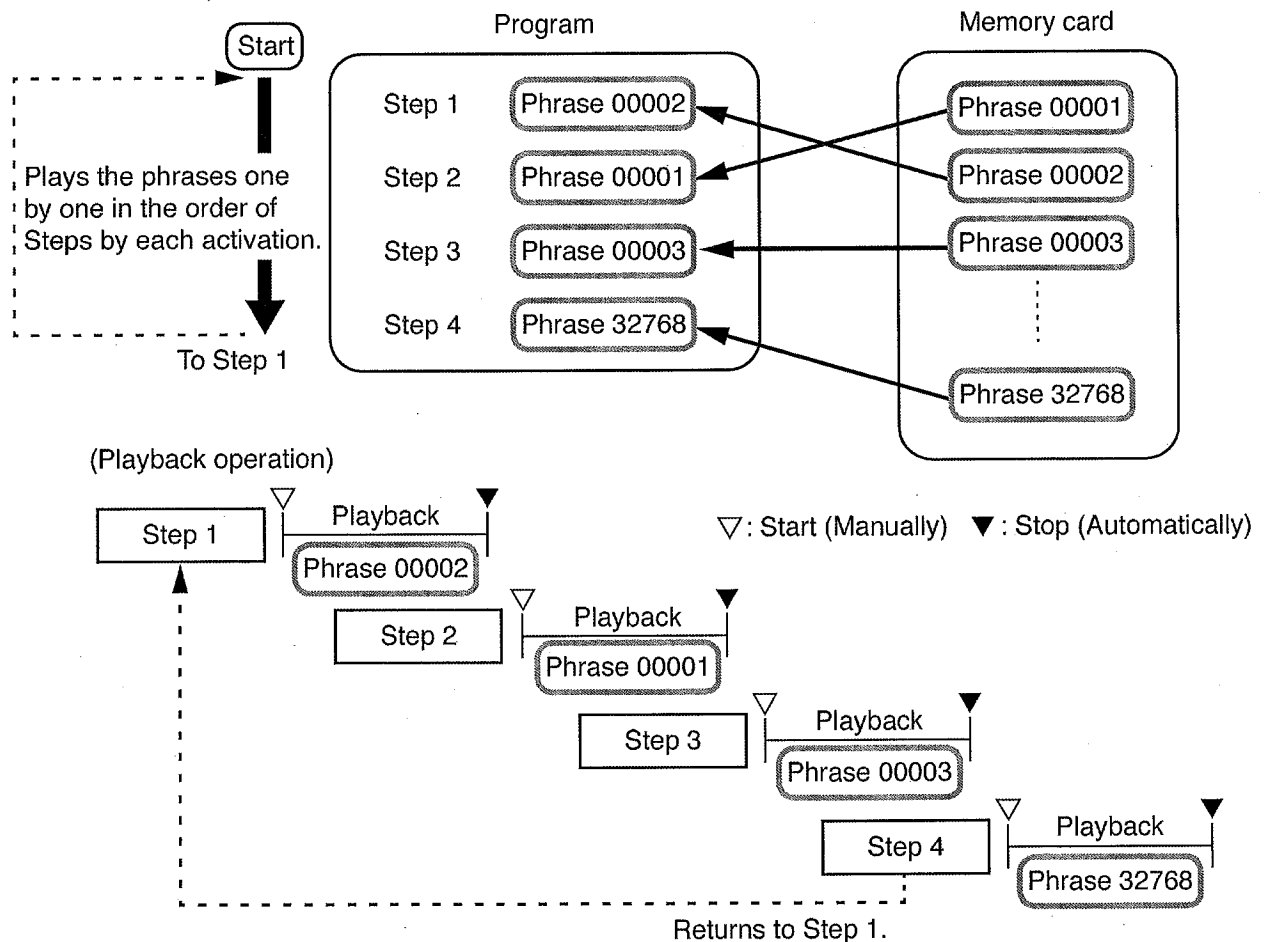

**[When Interval is set in the range of 10 seconds to 99 minutes]**

- When a program is activated, the phrase of the first Step will be played. When playback is complete, the next Step phrase will be played after the set interval. By repeating this process, playback stops when all Steps are played.
- Interval can be set in the range of 10 to 50 seconds (in 10-second units) and 1 to 99 minutes (in 1-minute units). Default setting is "OFF."
- Busy output ON/OFF during interval can be set using the EV-700 Setting software.
- Monitor playback of all Steps will start when the Monitor key is pressed.

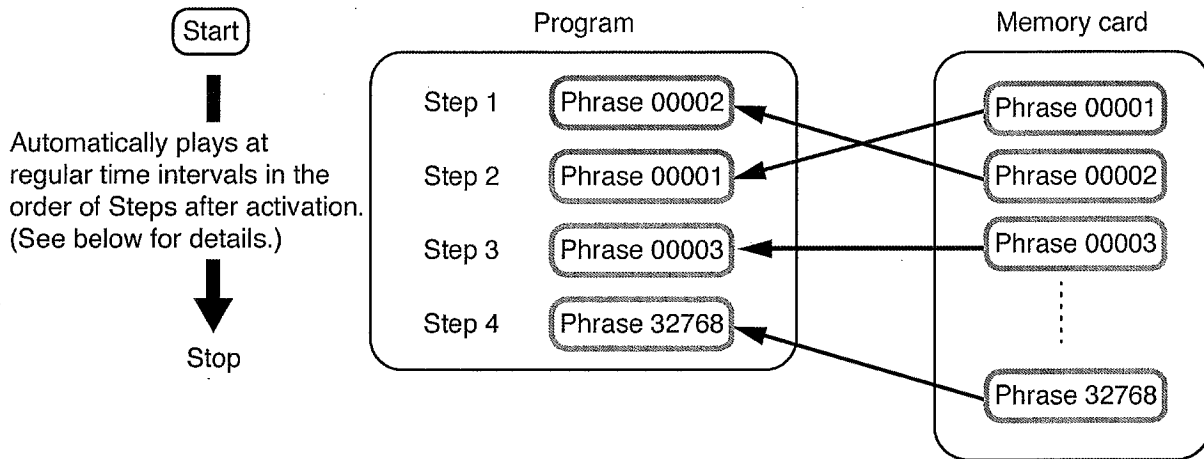

(Playback operation)

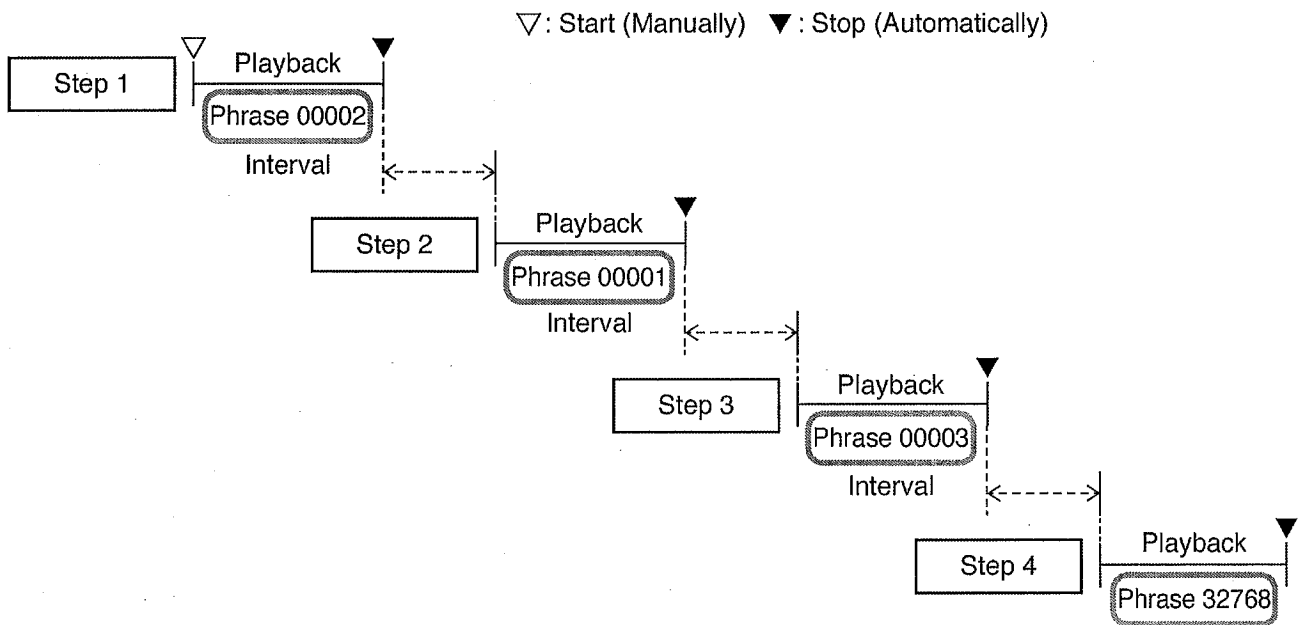

## All phrases playback

Repeatedly plays phrases contained in a memory card in the order of phrase numbers. This playback system is suited for the broadcasts repeated all day such as BGM and fixed announcements.

- After the last phrase is played, playback returns to the first phrase and continues thereafter.
- Interval between phrases can be set in the range of 0 to 5 seconds (1-second units).
- Busy output ON/OFF during interval can be set.
- To stop playback, perform any of the following operations: Pressing the Start/Stop key (See p. 21.), Closing the Stop control input terminals (See p. 33.), and Using the EV-700 Setting software. (See the EV-700 Setting software instruction manual.)
- The first phrase to be played can be designated.
- Playback starts from the initial phrase when it has been stopped halfway and activated again.
- Playback starts from the initial phrase when the program of the original All phrases playback is activated again while another program activated during original program playback is being played.

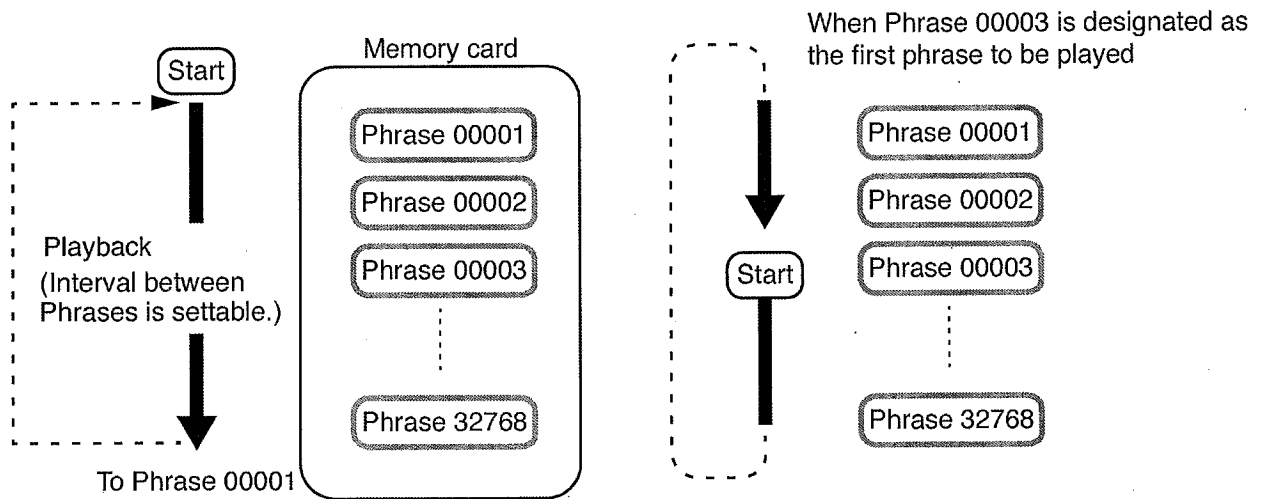

## Chime playback

This playback system is suited when the EV-700 is used as chime audio source of the remote microphone.

- Delay time is fixed at "0" second regardless of the unit setting.
- Busy output is not active regardless of the unit setting.
- Only 1 step is played.

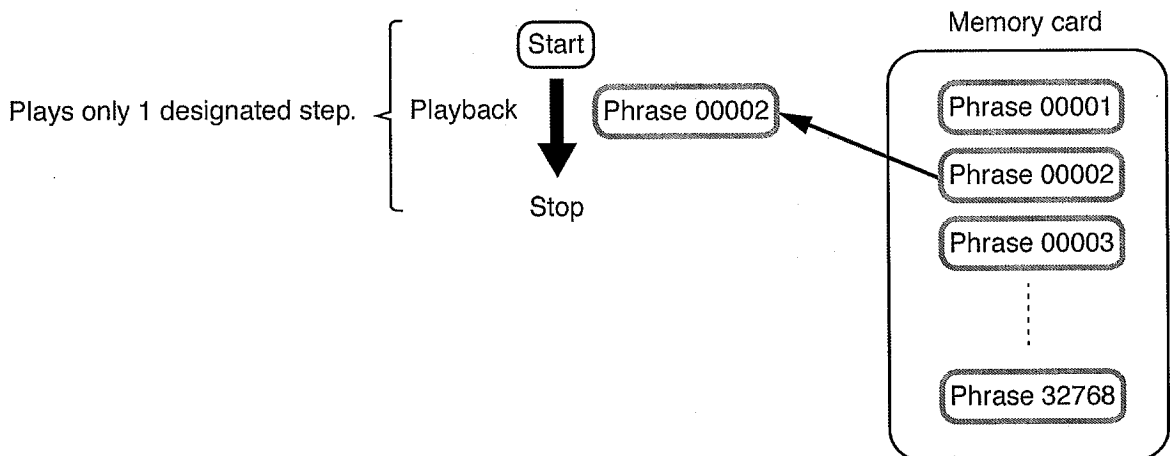

(Example of playback operation)

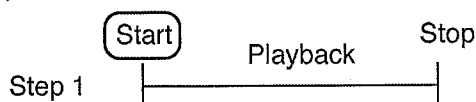

## 18. MAINTENANCE FUNCTION

When any one of the switches of the DIP switch for Maintenance located inside the unit's front-mounted cover is set to the ON position, the unit is placed in Maintenance mode, enabling the memory card backup and the maintenance such as initialization of the unit settings.

The Maintenance indicator will light when the unit is placed in Maintenance mode.

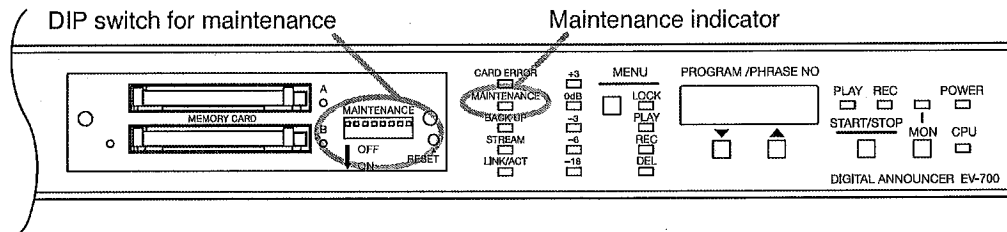

### Notes

- When in Maintenance mode, operation by way of contact activation and using the EV-700 Setting software cannot be made. When maintenance is complete, be sure to return all the switches of the DIP switch for maintenance to the OFF position.
- Using the EV-700 Setting software, it is also possible to place the unit in Maintenance mode to perform maintenance. In this case, the unit's maintenance indicator will light. No operation is allowed at the unit while this indicator is lighting.

### [Function of the DIP switch for maintenance]

The table below shows functions of each DIP switch for maintenance.

If a corresponding switch is set to the ON position, the unit is placed in Maintenance mode.

When you finish work in Maintenance mode, return the DIP switch to the OFF position.

If any one of the switches is set to the ON position, broadcast by way of contact control or using the EV-700 Setting software cannot be made.

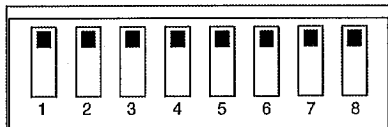

Switch	Function	Indication on the Status display	Ref. page
1	Used to play all programs and also adjust whole sound volume.	PGVoL	p. 72
2	Used to play, record, or delete Emergency playback audio source.	EMER	p. 52
3	Used to upload or download the setting files between the unit and memory card and also return the network setting to the default values* temporarily.	Download : SEtdL Upload : SEtdL	p. 74
4	Used to copy files on the memory card A to the memory card B.	CFCPy	p. 75
5	When set to the ON position along with Switch 8, the firmware recorded on the memory card is updated.	Displays the current firmware version number.	p. 76
6	When set to the ON position along with Switch 8, the unit setting is initialized.	Displays the target to initialize. Settings other than the network: unit Only network setting: nEt All settings: ALL	p. 77
7	Not used. Always keep this switch to the OFF position.	-	-
8	Use this switch in conjunction with Switch 5 or 6.	-	p. 76, 77

Setting item		Default value	Setting item	Default value
IP address		192.168.14.1	User ID	EV700
Subnet mask		255.255.255.0	Password	guest
Default gateway		0.0.0.0	Device name	EV-700
Port number	HTTP	8080	System name	EV-700
	FTP control port	21		
	FTP data port	20		
	Device control	60007		

## 18.1. Performing All-program Playback (Use Switch 1.)

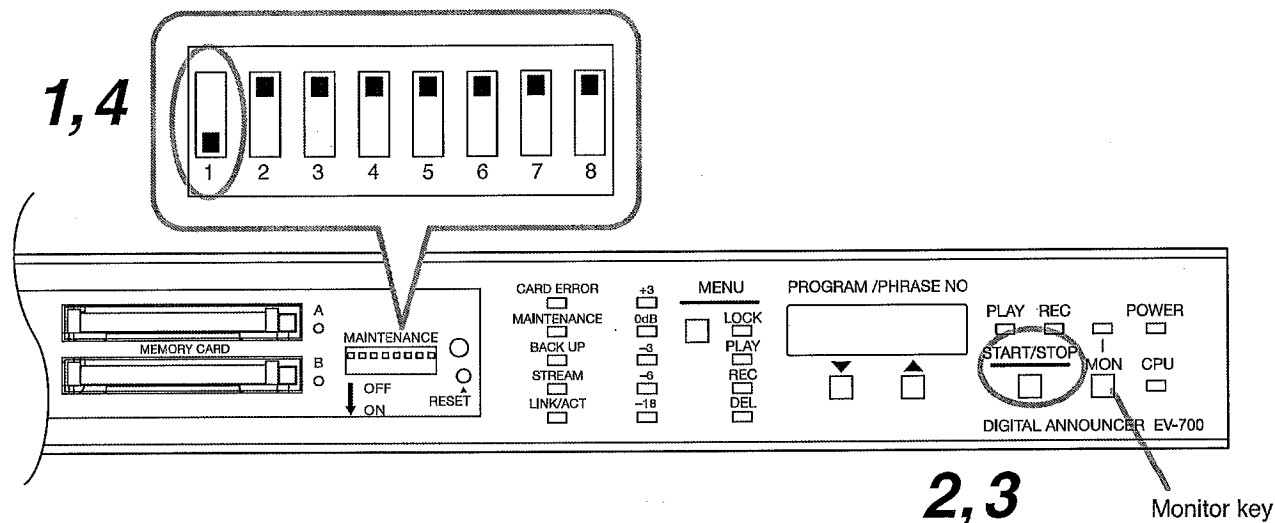

**Step 1.** Set Switch 1 to the ON position.  
The "PGVoL" indication appears on the Status indicator display.

### Tip

In this event, if the Monitor key is pressed, all programs are played for monitoring and the playback is output only to the headphones.  
Monitor playback stops if the Monitor key is pressed again during All-program playback.

**Step 2.** Press the Start/Stop key.  
All-program playback starts.  
When playback of all programs has finished, all-program playback is repeatedly played from the initial program.

**Step 3.** To stop playback, press the Start/Stop key.  
Playback stops.

**Step 4.** After All-program playback stops, return Switch 1 to the OFF position.

### Tips

- Interval and busy work according to the programmed settings during All-program playback.
- When the program playback system is set to Program playback, program is played once without repeating playback.
- Program of All phrases playback is not played.



## 18.2. Adjusting the Whole Sound Volume (Use Switch 1.)

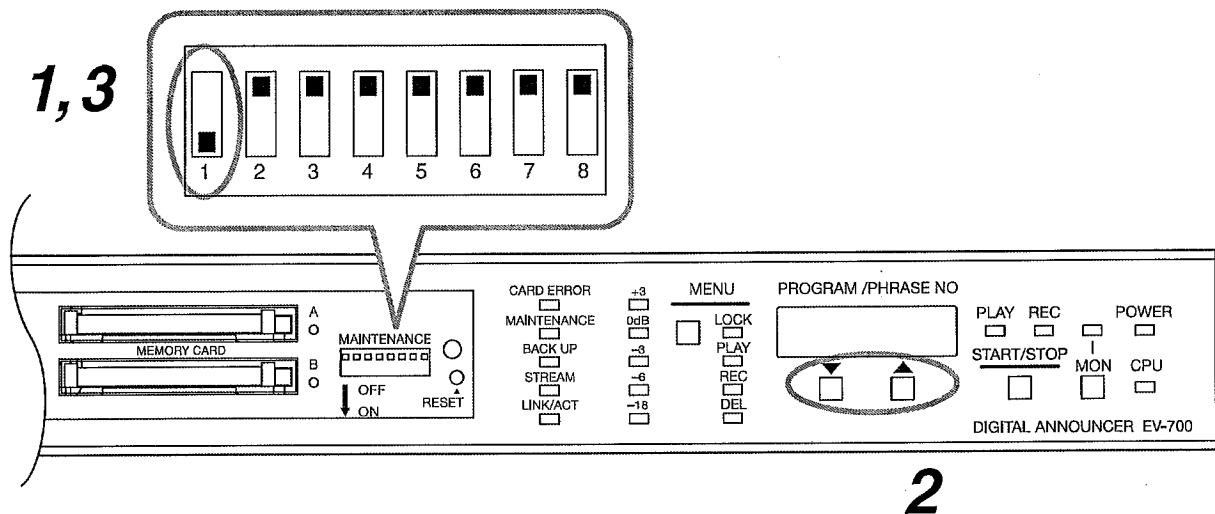

**Step 1.** Set Switch 1 to the ON position.  
The "PGVoL" indication appears on the Status display.

**Step 2.** Press the Up and Down keys to adjust the whole sound volume of program.  
The volume increases by 1 dB each time the Up key is pressed.  
It decreases by 1 dB each time the Down key is pressed.

**Step 3.** When you finish work, return Switch 1 to the OFF position.

### Tip

The whole sound volume set through this work does not affect the microphone input volume and the line input volume.

## 18.3. Playing, Recording, or Deleting Emergency Playback Audio Source (Use Switch 2.)

For details of operation, see p. 52, "EMERGENCY PLAYBACK (FRONT KEY OPERATION)."

## 18.4. Uploading/Downloading Unit Setting File (Use Switch 3.)

Insert the memory card into a PC after downloading the unit setting file from the EV-700 to the memory card, and you can confirm the setting file on the EV-700 Setting software.

Also, write the unit setting file to the memory card using the EV-700 Setting software in advance, then upload the setting file from the memory card to the EV-700 after inserting the card into the EV-700, and you can change the EV-700's settings.

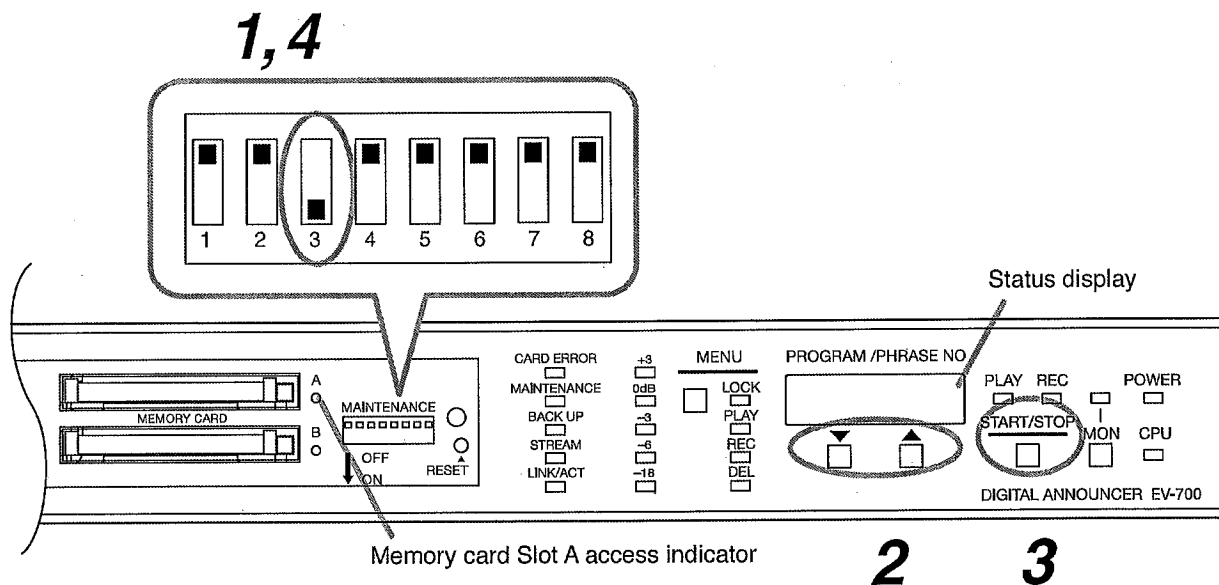

### [Downloading the unit setting file to the memory card]

**Step 1.** Set Switch 3 to the ON position.

**Step 2.** Press either the Up or Down key to select the "SEtDL" indication on the Status display.

**Step 3.** Press the Start/Stop key.  
Unit setting file is downloaded to the Memory card A.  
The Memory card slot A access indicator flashes during download.

**Step 4.** When the Memory card slot A access indicator stops flashing, return Switch 3 to the OFF position.

### [Uploading the unit setting file from the memory card]

**Step 1.** Set Switch 3 to the ON position.

**Step 2.** Press either the Up or Down key to select the "SEtUL" indication on the Status display.

**Step 3.** Press the Start/Stop key.  
Unit setting file is uploaded from the Memory card A to the EV-700.  
The Memory card slot A access indicator flashes during upload.

**Step 4.** When the Memory card slot A access indicator stops flashing, return Switch 3 to the OFF position.

## 18.5. Returning the Network Setting to the Default Value Temporarily (Use Switch 3.)

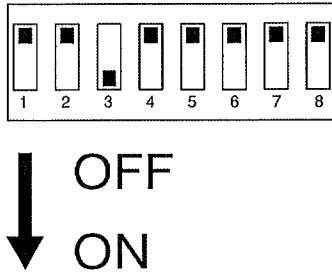

You can return the network setting to the default value only while Switch 3 is set to the ON position. Even when the network setting is unknown, use this function to return the network setting to the default value, and you can confirm and edit the setting using the EV-700 Setting software by connecting the PC to the EV-700 via a network.

## 18.6. Copying the Memory Card (Use Switch 4.)

You can copy data on the Memory card A to the Memory card B.

- All files on the Card A can be copied to the Card B.
- Files existing on the Card B but not on the Card A are left on the Card B.
- If the files are stored at the same location with the same file name on both the Cards A and B, the files on the Card A are overwritten to those on the Card B.

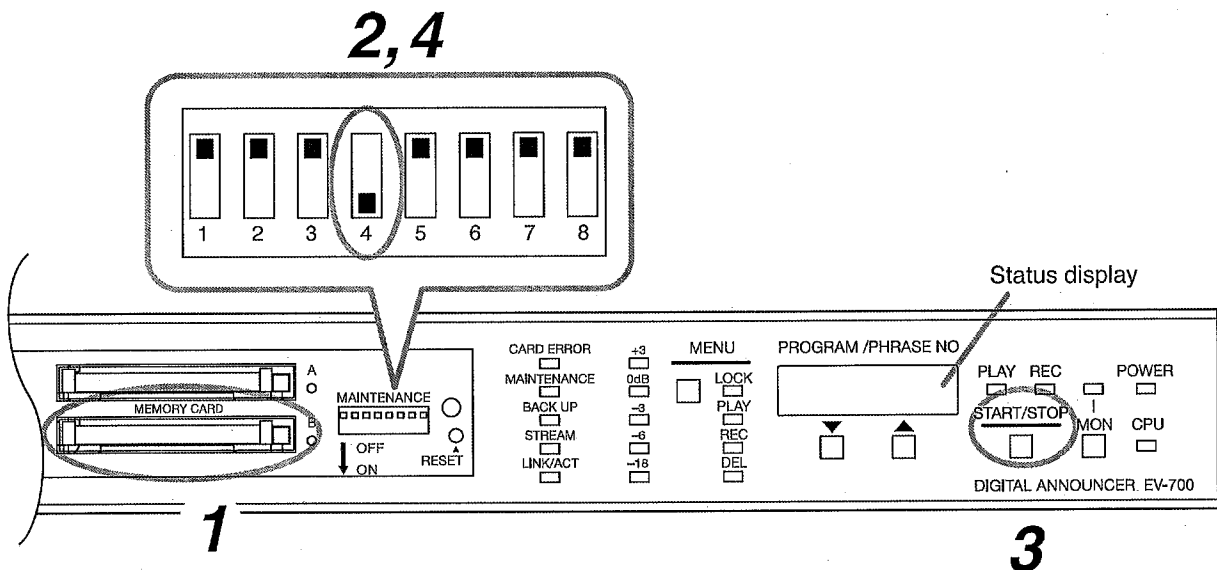

**Step 1.** Insert a memory card for backup into the Memory card slot B.

**Step 2.** Set Switch 4 to the ON position.  
The "CFCPy" indication appears on the Status display.

**Step 3.** Press the Start/Stop key.  
The files in the Memory card A are copied to the Memory card B.  
While the files are copied, figures from "0" to "9" are displayed repeatedly on the Status display.  
The "CFCPy" indication appears on the Status display when copy is completed.

**Step 4.** Return Switch 4 to the OFF position.

### Note

Once copying is started, it cannot be cancelled.  
Once Step 3 is started, the copy operation continues even if Switch 4 is returned to the OFF position before copy is complete, and the Maintenance mode still continues until copy is complete.

## 18.7. Updating the Firmware (Use Switches 5 and 8.)

You can update the firmware using the memory card on which the latest firmware is recorded.

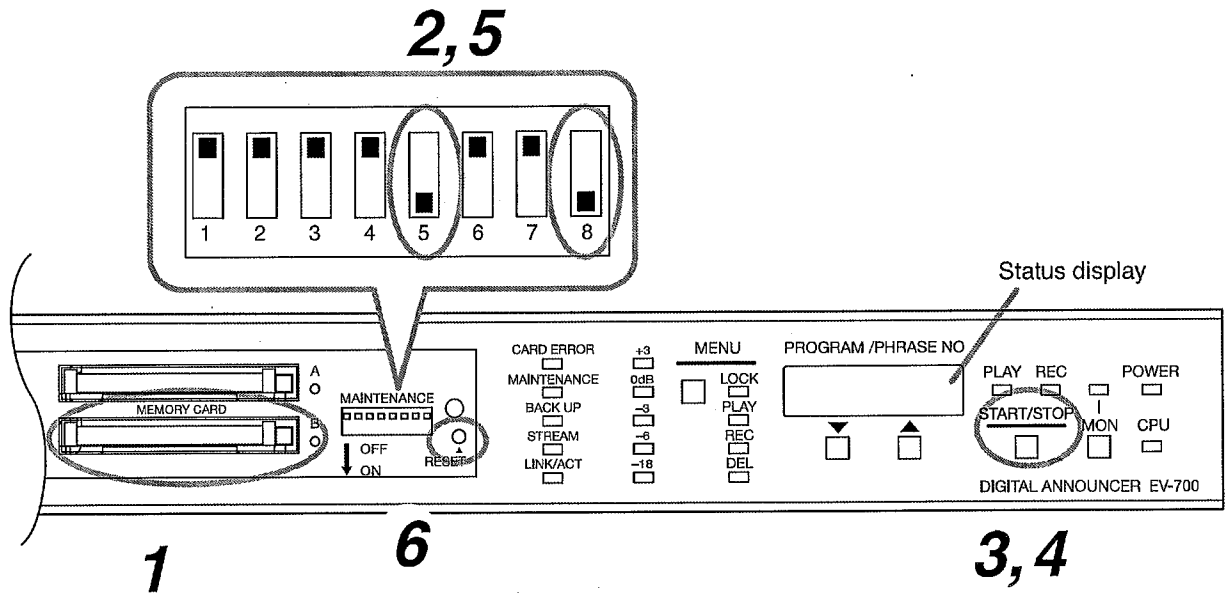

**Step 1.** Insert the memory card on which the latest firmware is recorded into the Memory card slot B.

**Step 2.** Set Switches 5 and 8 to the ON position.  
The current firmware version appears on the Status display.

**Step 3.** Press the Start/Stop key.  
The "rEAdy." indication appears on the Status display.

**Step 4.** Press the Start/Stop key.  
Firmware update begins. The countdown number appears on the Status display during update.  
The "uP.End" appears on the Status display when firmware update is complete.

**Step 5.** Return Switches 5 and 8 to the OFF position.

**Step 6.** Hold down the Reset switch for 2 seconds or more, or unplug the power supply cord on the rear panel, then plug it again.  
The unit restarts and the updated firmware is reflected to the unit.

## 18.8. Initializing the Unit Settings (Use Switches 6 and 8.)

You can initialize the unit's settings, returning them to the factory default.

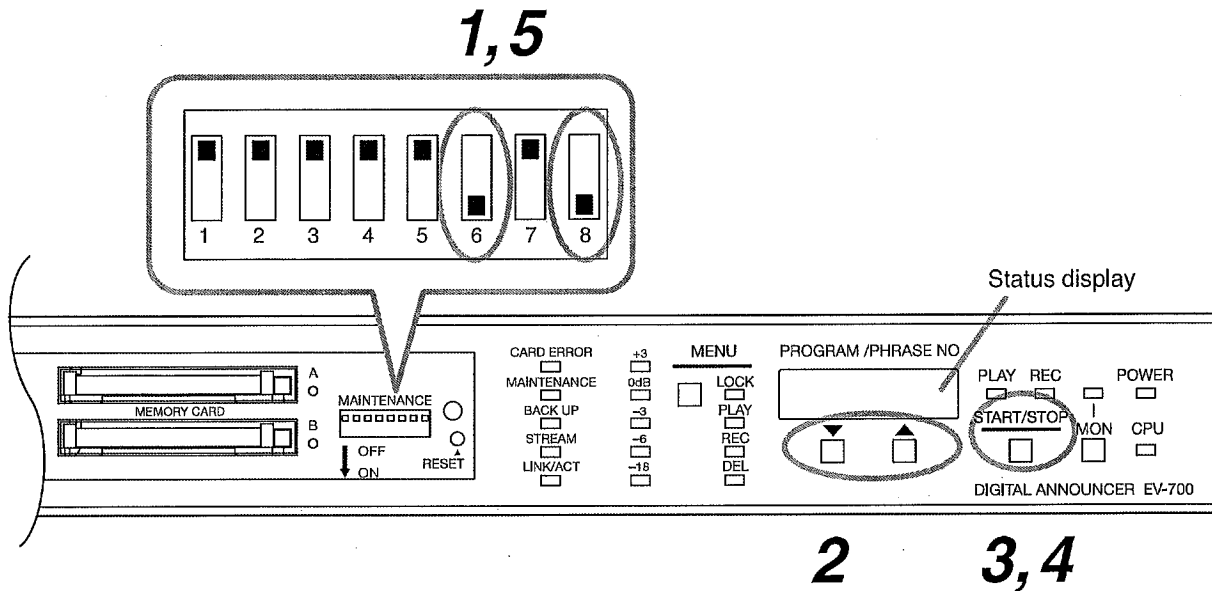

**Step 1.** Set Switches 6 and 8 to the ON position.

The target to initialize appears on the Status display.

Displayed indications represent the following contents.

"Unit": Unit settings other than the network setting

"nEt": Only network setting

"ALL": All settings recorded in the unit including the network setting

**Step 2.** Press either the Up or Down key to select the target to initialize.

**Step 3.** Press the Start/Stop key.

The "rEAdy." indication appears on the Status display.

**Step 4.** Press the Start/Stop key.

Initialization begins.

When initialization is complete, the "done" indication appears for about 1 second on the Status display, then the display returns to the indication in Step 1.

**Step 5.** Return Switches 6 and 8 to the OFF position.

## 19. CONFIRMING THE FIRMWARE VERSION

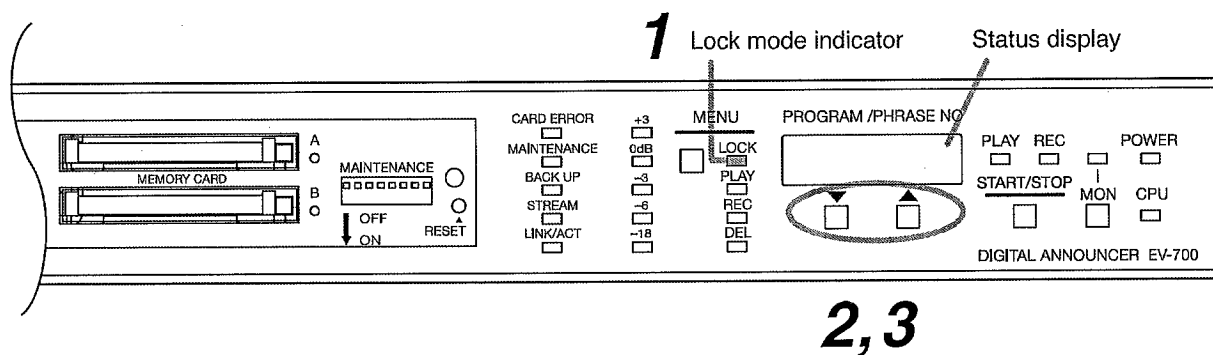

**Step 1.** Check that the Lock mode indicator is lighting.

**Step 2.** Press the Up and Down keys simultaneously.  
Firmware version appears on the Status display as long as the keys are held down.

**Step 3.** Release the keys.  
Indication disappears.

### Tip

Even during operation of the unit, the firmware version can be checked when the Lock mode indicator is lighting.

## 20. ACQUIRING OPERATION LOG

You can download the operation log recorded in the unit to the Memory card B.

### Note

You cannot download the log file to the Memory card B when the backup function is enabled.

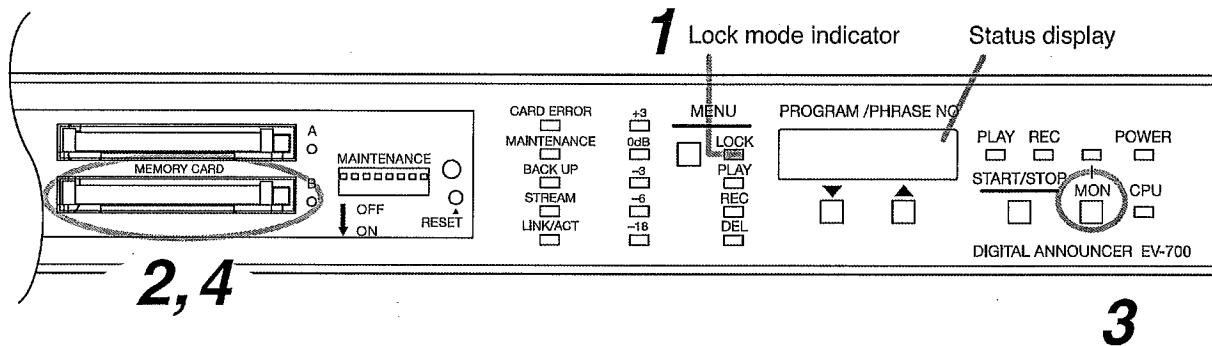

**Step 1.** Confirm that the Lock mode indicator is lighting when the unit is standby for operation.

**Step 2.** Insert a memory card (option) into the Memory card slot B.

**Step 3.** Hold down the Monitor key for 3 seconds or more.

The "Log" indication flashes on the Status display, and the operation log will be downloaded to the memory card B.

When the download is completed, the indication "done" appears on the Status display for about 1 second.

**Step 4.** Remove the Memory card B from the EV-700.

**Step 5.** Insert the Memory card B into a PC, then check the log using the EV-700 Setting software.

## 21. PRIORITY LEVEL SETTINGS

It is possible to assign Priority level so that the important contents can be preferentially played and broadcast. There are 2 priority levels, Broadcast priority level and Program priority level.

Set Broadcast priority levels among normal broadcast (broadcast of memory card audio sources), microphone announcement, and line input broadcast considering which broadcast takes precedence over which broadcast. (See p. 81, "Broadcast Priority Level.")

Program priority level can be set for each program and to any one of levels between "2" (high priority level) and "8" (low priority level).

Emergency playback and R.E.M. playback are fixed to Priority level 1 (the highest priority), which cannot be changed.

### Note

See the EV-700 Setting software instruction manual for details.

### Tip

Though Broadcast priority level takes precedence over Program priority level, Emergency playback and R.E.M. playback, both having Priority level 1, are played with the highest priority.

When the priority levels are set as in the table below, broadcasts operate as shown in the chart below.

### [Setting example]

Broadcast priority level	Program priority level
Microphone announcement: Broadcast priority level 1	P001: Program priority level 2
Normal broadcast: Broadcast priority level 2	Emergency playback: Program priority level 1 (fixed)

### [Operation]

- Microphone announcement is made when receiving a microphone input during program P001 playback.
- Emergency playback continues even when receiving a microphone input during Emergency playback broadcast.

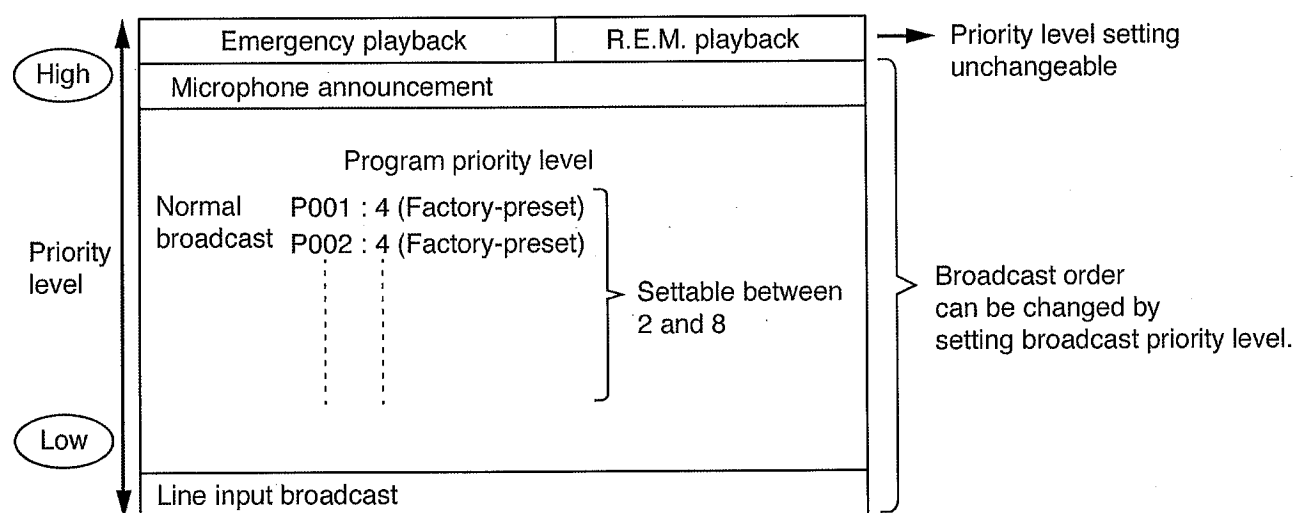



## 22. EXTERNAL INPUT BROADCAST

### 22.1. Outline

Besides the audio sources recorded on the memory card, audio signals entered to the front-mounted microphone input and those entered to the front-mounted and rear-mounted line inputs can be broadcast from the Line outputs 1 and 2.

One of the memory card audio source, microphone input signal, or line input signal can be broadcast depending on the preset priority level.

### 22.2. Broadcast Priority Level

#### Notes

- Broadcast priority level differs from the priority level that can be set for each program. (See p. 80, "PRIORITY LEVEL SETTINGS.")
- To make the microphone broadcast or line input broadcast, change the menu mode to Lock mode. If the EV-700 is placed in a mode other than Lock mode, the normal broadcast takes precedence regardless of the setting contents.

Broadcast priority level can be set among the normal broadcast, microphone broadcast, and line input broadcast. (For the setting procedures, read the EV-700 Setting software instruction manual.)

Priority level can be selected from "1," "2," "3," or "OFF" with "1" being the highest priority while "3" the lowest priority. If set to OFF, such broadcast is not output.

It is not possible to assign the same priority level.

The table below shows the factory default settings.

Type of broadcast	Broadcast priority level
Microphone broadcast	1
Normal broadcast	2
Line input broadcast	3

[Operation by the factory default setting]

- When there is a microphone input during normal broadcast  
Normal broadcast is interrupted and the microphone broadcast takes precedence.  
The memory card audio sources continue being played while the microphone broadcast is being made.  
The normal broadcast will resume if the playback of memory card audio sources still continues when the microphone broadcast ends.\*1

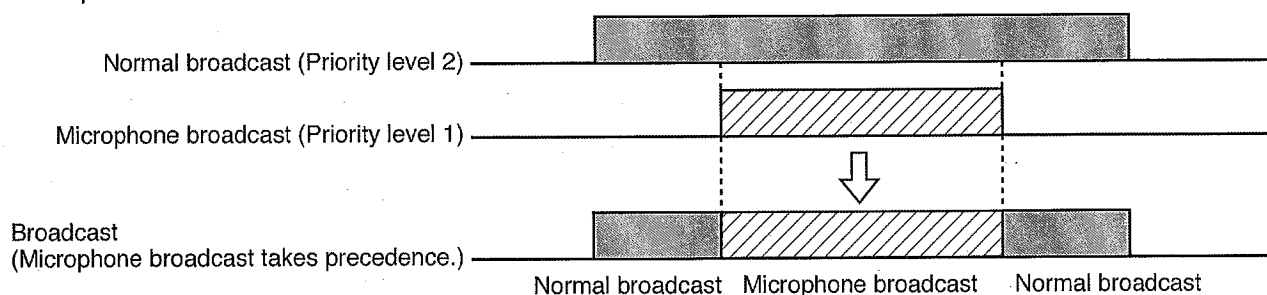

- When there is a line input during normal broadcast  
Line input signals are not output and the normal broadcast continues.  
Line input broadcast will be made if line input still continues when the normal broadcast ends.\*2

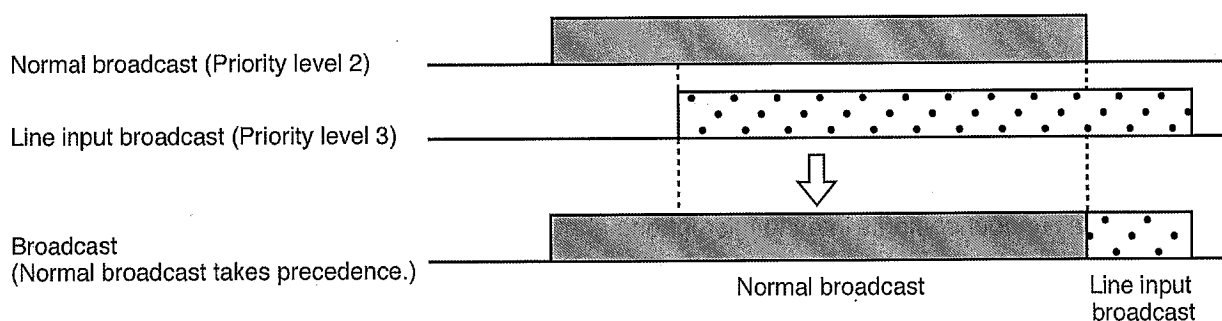

\*1 Normal broadcast will resume about 2 seconds after the microphone broadcast ends.

\*2 Line input broadcast will resume about 0.1 second after the normal broadcast ends.

## 22.3. Making External Input Broadcast

### Notes

- Adjust the output level of the microphone input or line input before broadcasting. When signals enter the microphone input or line input, it is judged that there are input signals if those levels are high enough to make the level meter flash.
- During recording, audio signals are output only from the headphone output terminal but not from the Line output 1 nor Line output 2.

### Tips

- Adjust the sound volume of the microphone input and line input with each corresponding input volume control only.
- Signals entered to the front-mounted and rear-mounted Line input terminals are internally mixed and output.

### 22.3.1. Making the microphone broadcast

Separately prepare a dynamic microphone with ON/OFF switch meeting the following EV-700's input specifications.

Microphone input specifications:  $-55$  dB ( $0$  dB =  $1$  V),  $600$   $\Omega$ , unbalanced, phone jack

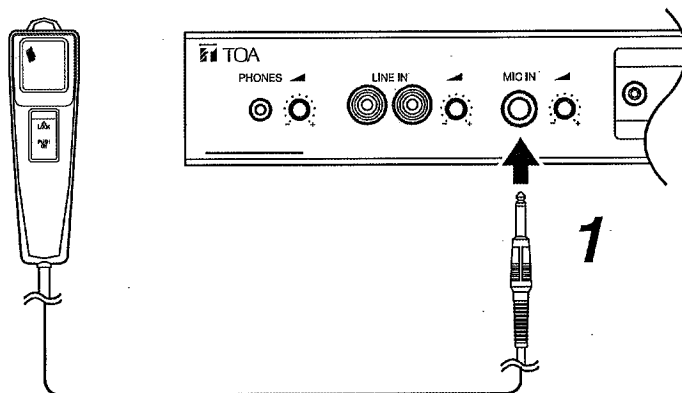

**Step 1.** Connect a microphone to the front-mounted microphone input jack.  
Before connecting a microphone, set the microphone switch to OFF and rotate the microphone input volume control fully counterclockwise.  
For the method to make the microphone ON/OFF setting, read the instruction manual attached to the microphone.

**Step 2.** Set the microphone switch to ON, then adjust the microphone input volume while speaking into the microphone.  
Adjust the microphone input volume with the Microphone input volume control while watching the level meter.  
Take care so that "+3" LED of the level meter is not constantly lighting.

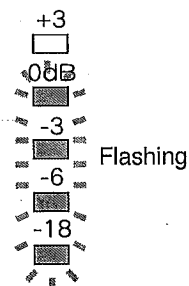

**Step 3.** Set the microphone switch to OFF after adjustment is complete.  
Preparation for the microphone broadcast has been completed.

**Step 4.** Speak announcements into the microphone after setting the microphone switch to ON when needed.

### 22.3.2. Making the Line input broadcast

For an external audio player connected to the line input, separately prepare the one meeting the following EV-700's input specifications.

Line input specifications:  $-20\text{ dB}$  ( $0\text{ dB} = 1\text{ V}$ ),  $10\text{ k}\Omega$ , RCA jack (front-mounted line input)/Removable terminal block (rear-mounted line input)

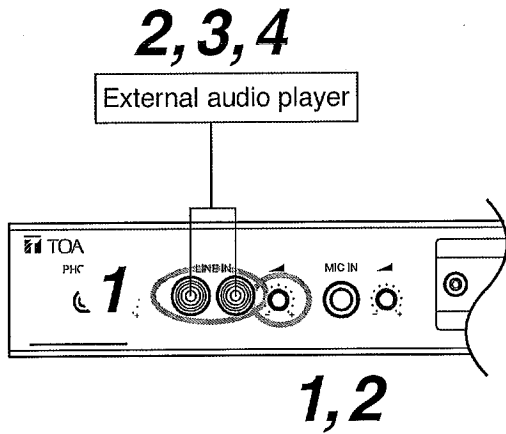

When connecting an external audio player to the unit's rear-mounted terminals

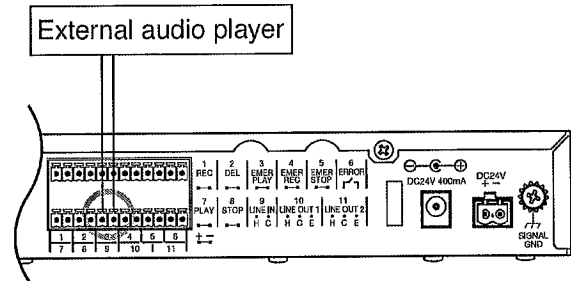

**Step 1.** Connect an external audio player to the Line input terminal.  
Before connecting an external audio player, rotate the Line input volume control fully counterclockwise.

**Step 2.** Start the external audio player, then adjust the line input volume.  
Adjust the line input volume with the Line input volume control while watching the level meter.  
Take care so that "+3" LED of the level meter is not constantly lighting.

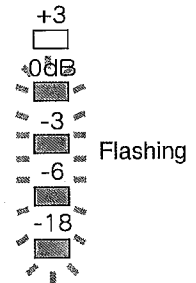

**Step 3.** Stop the external audio player.  
Preparation for the Line input broadcast has been completed.

**Step 4.** Play the audio sources using the external audio player when needed.

#### Note

Depending on the priority level setting, the line input broadcast may be interrupted if the higher-priority broadcast is initiated during broadcast.

In this case, check the broadcast priority level setting. (See the EV-700 Setting software instruction manual.)

#### Tips

- Stereo input signals, if entered, are converted into monaural signals after the left and right channel signals are internally mixed.
- Signals entered to the Line input terminal and those entered to the Line input terminals in the rear-mounted block terminal are internally mixed.

## 23. BROADCAST SOUND VOLUME

### 23.1. Sound Volume of Normal Broadcast and Emergency Broadcast

Sound volume of the normal broadcast and the emergency broadcast is determined by the program sound volume, whole sound volume, and Automatic gain control (AGC).

Use the EV-700 Setting software to perform the program sound volume setting, whole sound volume setting, and ON/OFF setting of the Automatic gain control (AGC).

For each setting method, see the EV-700 Setting software instruction manual.

#### 23.1.1. Program sound volume

Program sound volume is the sound volume that can be set to each program, the emergency playback, and the R.E.M. playback. It can be set in 11 increments. Its initial setting is "8."

Setting value	0	1	2	3	4	5	6	7	8 (Initial value)	9	10
Program sound volume	-60 dB	-30 dB	-24 dB	-18 dB	-12 dB	-9 dB	-6 dB	-3 dB	0 dB	+3 dB	+6 dB

**Tip:** Each dB value represents the ratio given with reference to the sound volume of the audio source data.

#### 23.1.2. Whole sound volume

Whole sound volume is the overall sound volume for each program, the emergency playback, and the R.E.M. playback. It can be set in 1-dB units in the range of -60 to 0 dB. Its initial setting is "-6 dB."

##### Tip

Whole sound volume can also be set through operation at the EV-700. (See p. 73, "Adjusting the Whole Sound Volume (Use Switch 1).")

#### 23.1.3. Total sound volume (refers to the sum of the program sound volume and the whole sound volume)

If the program sound volume and the whole sound volume have been set, the total sound volume is determined in the range of -60 to 0 dB based on them, and broadcast is made with this total sound volume.

- If the sum of the program sound volume and the whole sound volume is between -60 and 0 dB, such value is the total sound volume.
- If the sum of the program sound volume and the whole sound volume is less than -60 dB, "-60 dB" is the total sound volume.
- If the sum of the program sound volume and the whole sound volume exceeds 0 dB, "0 dB" is the total sound volume.

##### Tip

When the total sound volume is -6 dB, a signal of 0 dB\* is output from the line output.

\* 0 dB = 1 V

#### 23.1.4. Automatic gain control (AGC)

Automatic gain control (AGC) functions to adjust the sound volume at playback as close to the set value (reference level) as possible.

Broadcasts can be made by suppressing the variation in the reproduced sound volume from a small level to a large level.

ON/OFF setting can be made individually for all programs including the emergency playback and the R.E.M. playback.

##### Tips

- The reference level for the Automatic gain control (AGC) is determined by the total sound volume (the sum of the program sound volume and the whole sound volume).  
Playback sound volume becomes large when it is smaller than the reference level, and becomes small when it is larger than the reference level.
- When the program sound volume or the whole sound volume is changed, the reference level of the Automatic gain control (AGC) changes, thereby varying the broadcast volume level.
- When using the Automatic gain control (AGS), it is recommended that total sound volume level be set in the range of -30 to 0 dB.

## 23.2. Sound Volume of the Microphone Broadcast and the Line Input Broadcast

Adjust the recording volume and broadcast volume of the Microphone broadcast and Line input broadcast with each corresponding input volume control. (See p. 22, "Recording to Phrase." and p. 82, "Making External Input Broadcast.")

### Tip

Sound volume of the Microphone broadcast and the Line input broadcast are not affected by the Program sound volume, whole sound volume, and AGC.

## 24. DELAY TIME

Set the delay time when it takes too long time to start up an amplifier or external device, causing the head cutting of the playback content.

The delay time from the program playback startup until audio signal playback actually begins can be set in the range of 0 to 99 seconds in 1-second units.

For the setting procedures, read the EV-700 Setting software instruction manual.

### Tips

- The program playback busy signal is output even during delay time.
- Delay time setting applies to all programs including the emergency playback and the R.E.M. playback except the case that the playback system is set for Chime playback.

## 25. CONTROL OUTPUT (BUSY SIGNAL)

### 25.1. What is Busy Signal?

A make contact control output (busy signal) can be output from the Contact control output terminal during operation of the unit such as program playback in progress.

Using the EV-700 Setting software, it is possible to set what type of busy signal is output from which channel of the contact control output terminals 1 to 8 when the device performs the following operations.

For the details, read the EV-700 Setting software instruction manual.

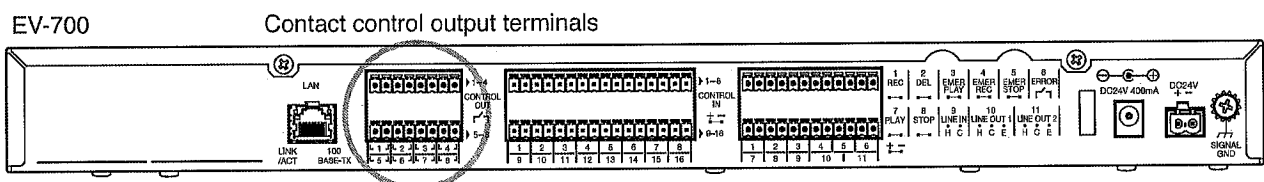

## 25.2. Setting a Busy Signal

### 25.2.1. Setting

To set the busy signal, use the EV-700 Setting software.

Busy signal name	Content	Default setting
Line output busy	The busy signal is output during audio signal output from the Line outputs 1 and 2.	1-8: OFF
Program playback busy	The busy signal is output during program playback or during emergency audio source playback in the maintenance mode. You can set the channel of the contact control output terminal that outputs the busy signal for each program.	1-8: ON
Microphone broadcast busy	The busy signal is output during microphone broadcast.	1, 2: ON, 3-8: OFF
Line input broadcast busy	The busy signal is output during line input broadcast.	1-8: OFF
Recording busy	The busy signal is output during recording or during emergency audio source recording.	1-8: OFF
Delete busy	The busy signal is output during deletion or during emergency audio source deletion.	1-8: OFF
Emergency playback busy	The busy signal is output during emergency playback or during R.E.M. playback broadcast.	1, 2: ON, 3-8: OFF
R.E.M. busy	The busy signal is output during R.E.M. playback recording.	1-8: OFF
Maintenance busy	The busy signal is output while the unit is in Maintenance mode.	1-8: OFF

See the EV-700 Setting software instruction manual for details.

### 25.2.2. Operation of the busy signal

A make signal is output from the Contact control output terminals 1 through 8 set for the operation type as a busy signal during operation.

The output operation of the busy signal shown below is an example of the busy signal output set for the "Program playback busy" on the setting screen above.

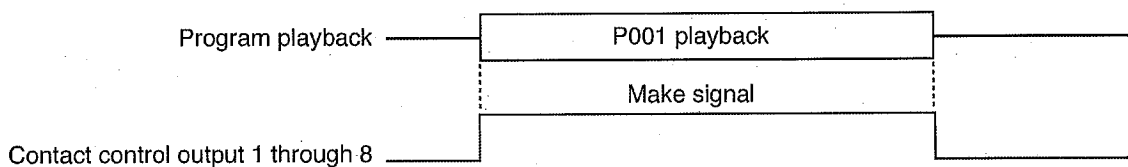

**Note:** For the busy setting that can be set for each program such as the busy input during repeat interval, read the EV-700 Setting software instruction manual.

## 26. ERROR OUTPUT

A Make contact is output at the Error output terminals when the unit is placed in the state below.

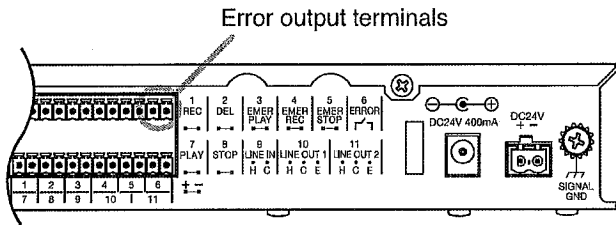

- When the unit is operating using the Memory card B
- When an unusable memory card is inserted
- When a card error occurs
- When the unit malfunctions (In this case, an error code will appear on the Status display. See p. 98, "Error List.")
- When the unit's power is off

## 27. BACKUP FUNCTION

Backup function allows the unit's operation to be maintained without interruption by switching the operating Memory card A to the backup Memory card B if the Memory card A fails due to an error like read error. Backup function ON/OFF setting can be made using the EV-700 Setting software.

The unit operates using the Memory card A only when the backup function is set to OFF. When the backup function is set to ON, note that a memory card on which all the Memory card A data are recorded needs be inserted into the Memory card slot B.

Therefore, be sure to make a backup copy of the Memory card A to the Memory card B in advance when wishing to use this function. (See p. 75.)

By comparing both data on the Memory cards A and B using the EV-700 Setting software, you can check whether they are identical or not.

See the EV-700 Setting software instruction manual for details.

### Note

Even if an error occurs on the Memory card B during operation using the Memory card B, the unit's operation will not automatically switch back to the operation using Memory card A. After removing the cause of the error on the Memory card A, be sure to switch to the operation by hand.

### 27.1. Enabling the Backup function

**Step 1.** Insert the memory card (accessory) containing audio data into the Memory card Slot A.

**Step 2.** Insert another memory card (option) into the Memory card Slot B.

**Step 3.** Make a backup copy of the Memory card A to the Memory card B.

Use Switch 4 of the DIP switch for maintenance for this operation. (See p. 75, "Copying the Memory Card (Use Switch 4).")

### Tip

You can also make a card copy using the EV-700 Setting software. (See the EV-700 Setting software manual.)

**Step 4.** Enable the Backup function using the EV-700 Setting software, then transfer the Setting file to the EV-700 unit.

(See the EV-700 Setting software manual.)

**Step 5.** Confirm that the Backup indicator is lighting.

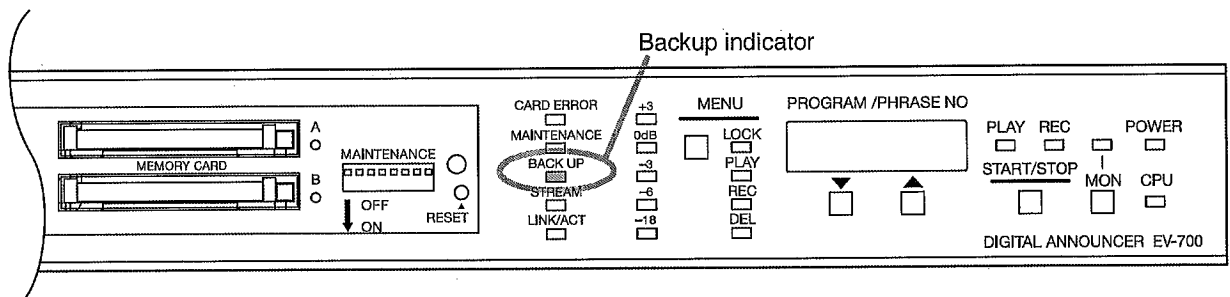



## 27.2. Operation of the Unit When the Backup Function Is Enabled

[When the Backup function is enabled]

- The Backup indicator lights.
- When rewriting data by the operation like recording or deletion with the Backup function enabled, both data on the Memory cards A and B are rewritten at the same time.

[When the backup function is activated if an error has occurred on the Memory card A]

- If data reading on the Memory card A fails when playback start is triggered, data is read immediately from the Memory card B, allowing the playback to start. Operation is maintained thereafter using the Memory card B.
- If data reading on the Memory card A fails during playback, data is read immediately from the Memory card B, allowing the playback to start from the beginning of the phrase that was being played. Operation is maintained thereafter using the Memory card B.
- The Memory card B in-use indicator flashes and an error signal is output when the Memory card B takes over the operation by the Backup function.

### Note

Noise may be produced when switched to the operation by the Memory card B.

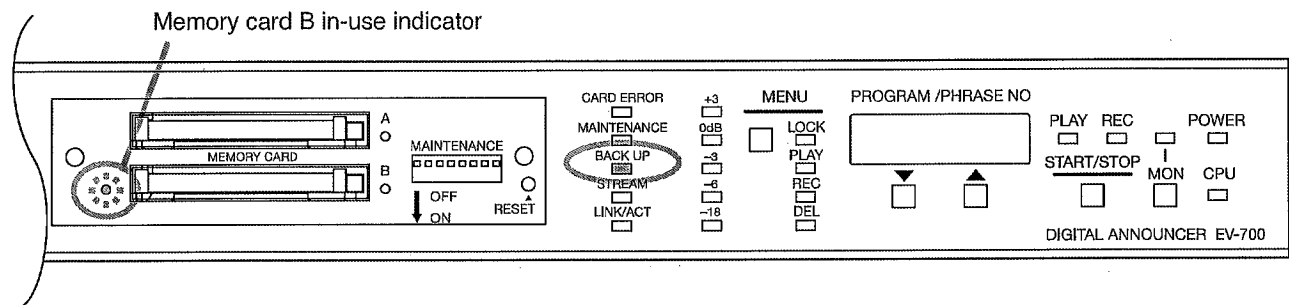

- Operation by the Memory card B is the same as that by the Memory card A.
- No playback is performed if data reading on the Memory card B fails when playback start is triggered during operation using the Memory card B.

## 27.3. Returning the Operation Using the Memory card B to That Using the Memory card A

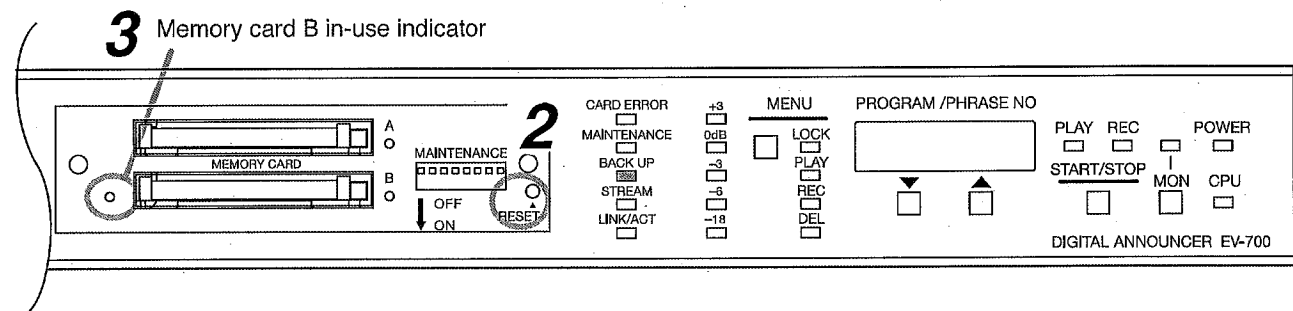

**Step 1.** Correct the data on the Memory card A.

**Step 2.** Press the Reset switch for 2 seconds or more, or disconnect the AC adapter plug on the rear panel, then connect it again.

### Tip

Operation can also be switched to that handled by the Memory card A using the EV-700 Setting software.

(See the EV-700 Setting software instruction manual.)

**Step 3.** Confirm that the Memory card B in-use indicator is unlit.

## 28. INSTALLATION

### 28.1. Mounting the Unit in an Equipment Rack

When mounting the unit in an equipment rack, use the optional MB-15B Rack mounting bracket.

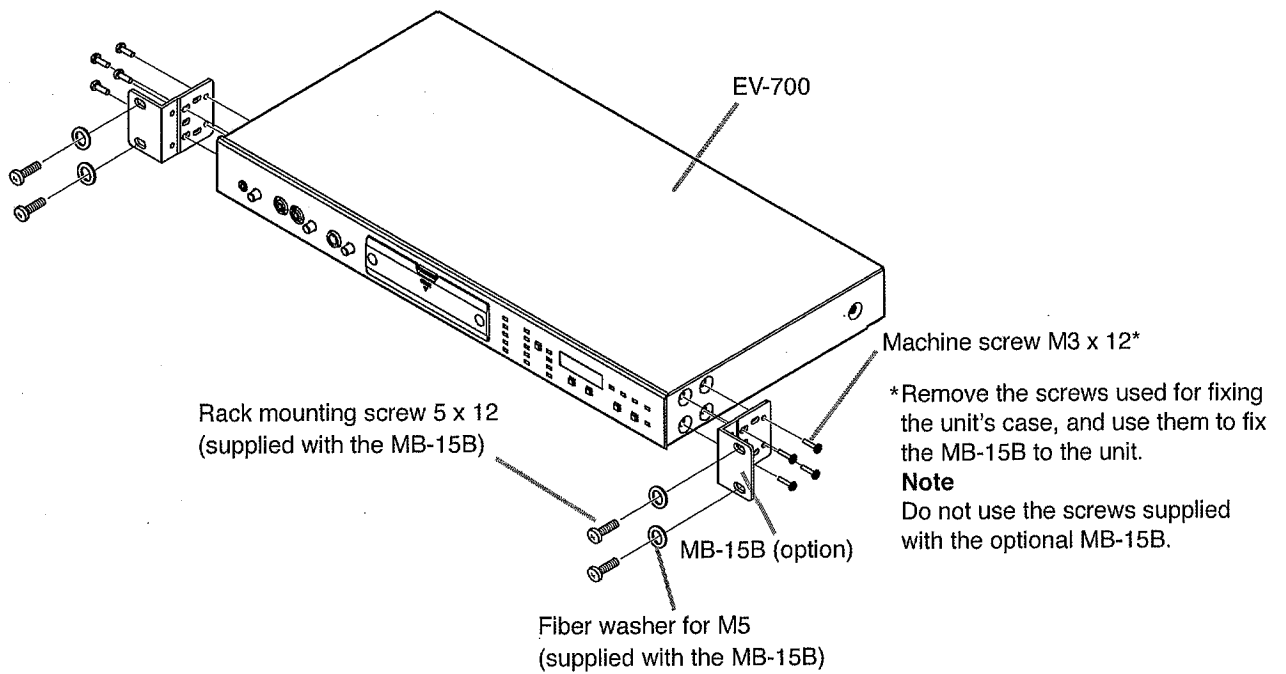

### 28.2. Installing the Unit on the Desk

When installing the unit on the desk, attach the supplied rubber feet to the unit's bottom surface.

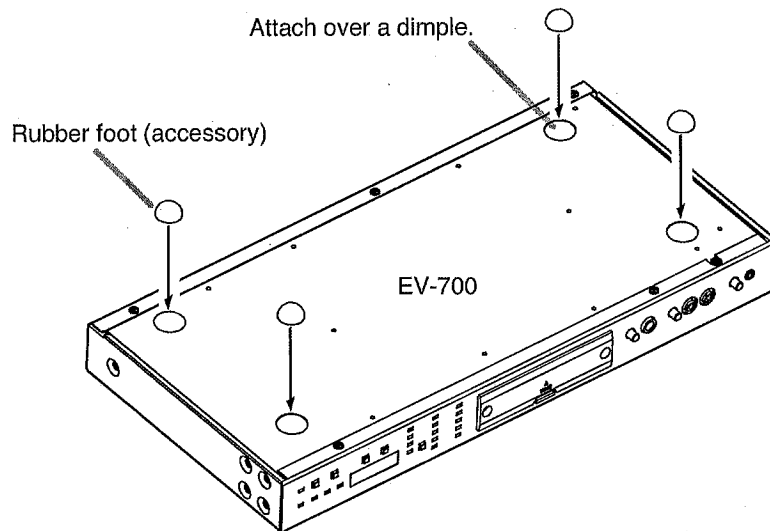

## 29. CONNECTIONS

### Note

When connecting the power source to the EV-700 or when connecting the EV-700 to the external audio player or amplifier, be sure to switch off the power of all devices.

### 29.1. Front Panel Connections

[Connection example]

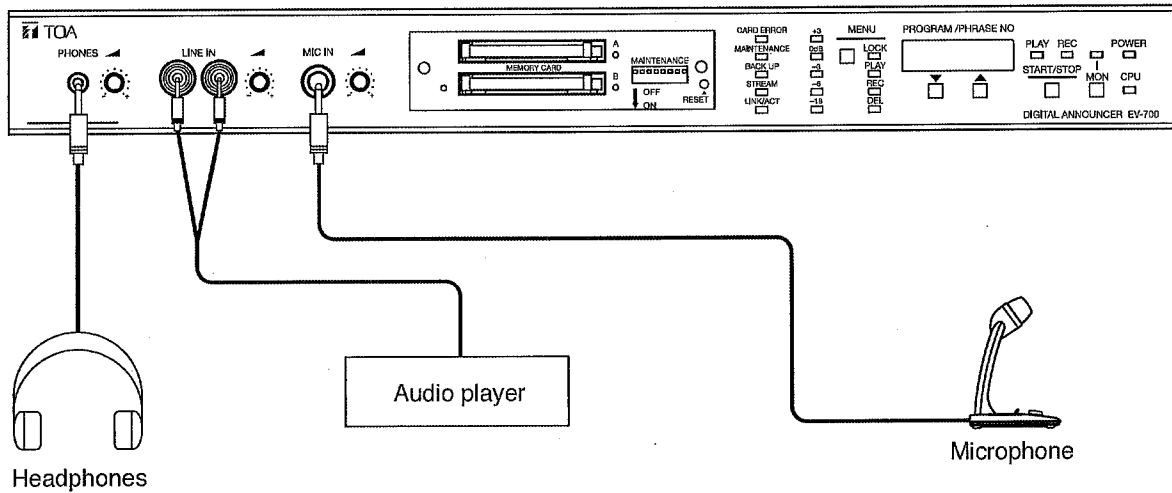

- Audio sources connected to the front-mounted Line input jacks and those connected to the rear-mounted Line input terminals are internally mixed.
- When an audio source is connected to the front-mounted Line input terminals, the sound volume of the audio source of the Line input becomes larger compared to when the audio source is connected to the rear-mounted Line input terminals only.
- Stereo input signals, if entered, are converted into monaural signals after the left and right channel signals are internally mixed.
- During recording, microphone input signals and line input signals are not output from the Line output terminals 1 and 2. To confirm the recorded contents (to monitor), use the headphone output. (See p. 27, "Confirming the Recorded Contents on Memory Card.")
- Audio signals from the Line output terminals 1 and 2 are not muted even if you connect headphones to the headphone jack during playback.

## 29.2. Rear Panel Connections

For the operations and functions of each terminal, see p. 12, "Rear" of "NOMENCLATURE AND FUNCTIONS."

### [Connection example]

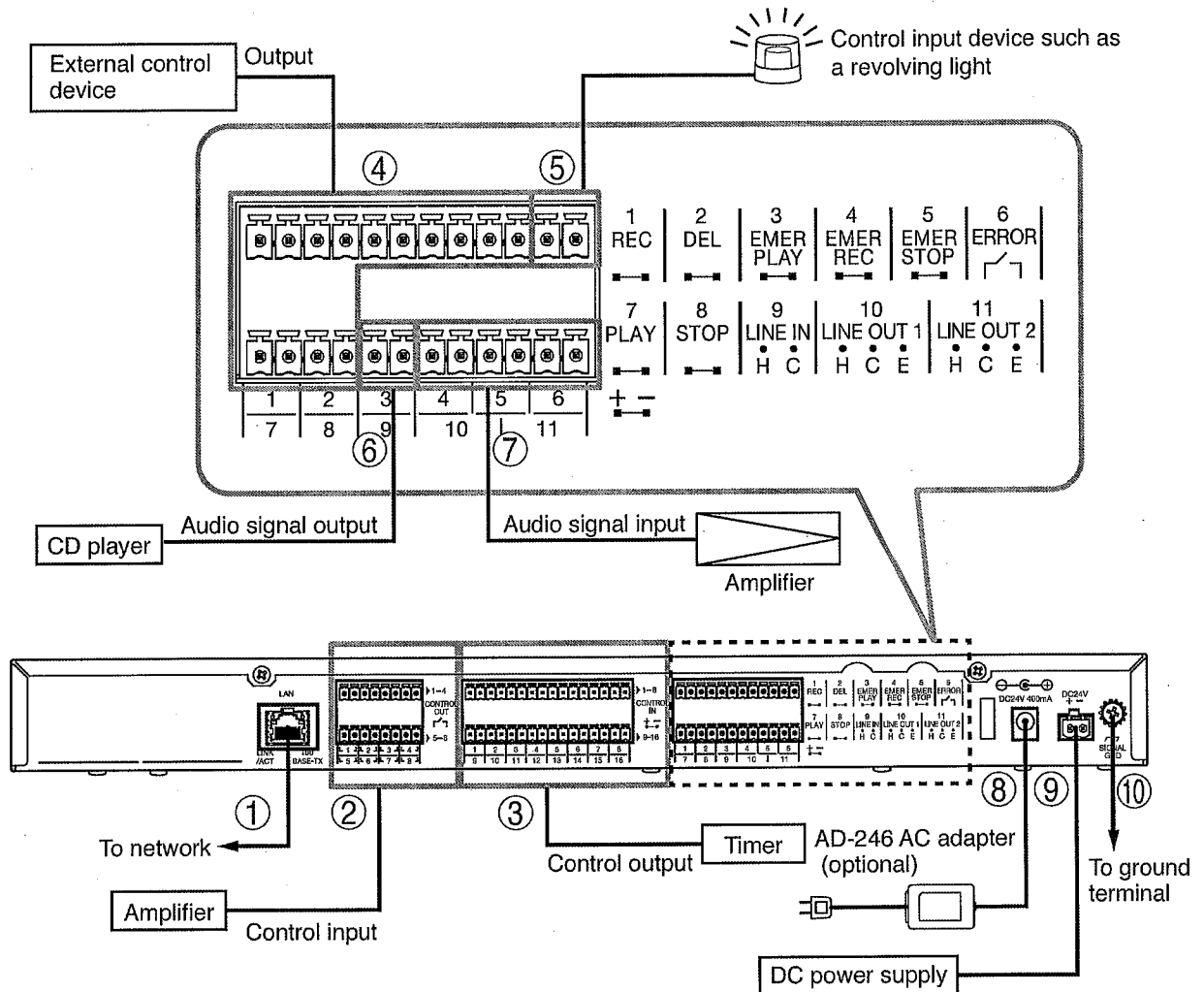

Use the supplied removable terminal plugs for connection to (2) through (7) and (9). (See p. 94, "Removable Terminal Plug Connection.")

The number of each plug's poles is as follows.

(2) 8P, (3) 16P, (4) through (7) 12P, (9) 2P

#### 1. LAN terminal

Connect to a 100BASE-TX-compatible network.

Use an Ethernet RJ45 jack for connection.

#### 2. Contact control output terminal

No-voltage make contact, 30 V DC, 500 mA

Connect to the control input terminal such as amplifier's power control input terminal that will work with a make contact.

##### Note

When directly controlling the amplifier's power source, make connection via a relay having enough contact capacity.

#### 3. Contact-activated input terminal

No-voltage make contact, open voltage: 30 V DC, short-circuit current: 10 mA, short-circuit duration: 50 ms or more

Connect to the external control device such as a timer that outputs a make contact.

#### 4. Various control input terminals

No-voltage make contact, open voltage: 30 V DC, short-circuit current: 10 mA, short-circuit duration: 50 ms or more

Connect the switches to remotely activate operations such as recording and playback, or the external control devices that output make contact. (See p. 28, "ACTIVATING OPERATION BY WAY OF EXTERNAL CONTROL.")

#### 5. Error output terminal

No-voltage make contact, 30 V DC, 500 mA

Normally open, and closed when a device error or memory card error occurs. (See p. 87, "ERROR OUTPUT.")

#### 6. Line input terminal

-20 dB\*, 10 k $\Omega$ , unbalanced

Connect an external audio player for recording and broadcasting to this terminal.

Figure below shows the connections.

(Single core shielded cable)

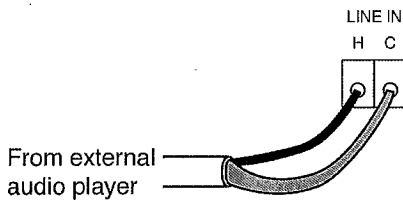

(2-core shielded cable)

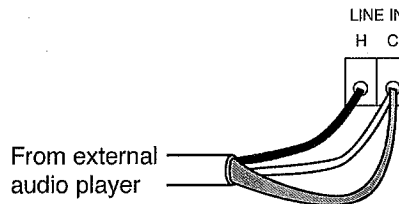

#### 7. Line output terminals 1 and 2

0 dB\*, 600  $\Omega$ , balanced

Connect to the amplifier's audio input terminal.

Figure below shows the connections.

(Single core shielded cable)

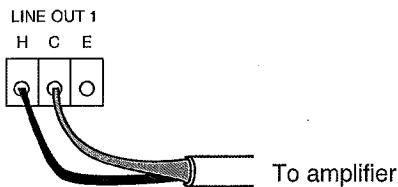

(2-core shielded cable)

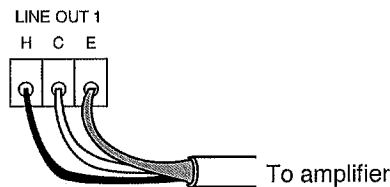

#### 8. AC adapter input terminal

Connect an optional AD-246 AC adapter to this terminal.

When connected, secure the cable through the cable clamp as shown at right to prevent the AC adapter's plug from accidentally coming off from the input terminal.

##### Tip

When applying power to this terminal and the DC power input terminal (9) simultaneously, the higher side voltage is supplied to the EV-700.

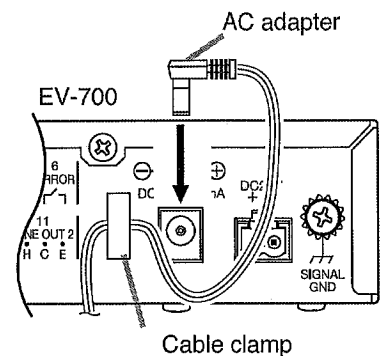

#### 9. DC power input terminal

Connect 24 V DC power to this terminal.

#### 10. Functional ground terminal

Connect to the ground terminal or chassis ground.

##### Note

This terminal is not for protective ground.

## 29.3. Removable Terminal Plug Connection

### Notes

- Use the slotted screwdriver when connecting the removable terminal connector.
- Avoid soldering stranded or shielded cable, as contact resistance may increase when the cable is tightened and the solder is crushed, possibly resulting in an excessive rise in joint temperatures.
- Applicable cable size

	For DC power input terminal	For other terminals
Conductor cross-section area	0.2 – 2.5 mm <sup>2</sup>	0.14 – 1.5 mm <sup>2</sup>
AWG	AWG 24 – 12 or equivalent	AWG 28 – 16 or equivalent

- When connecting 2 cables or a shielded cable to a single terminal, use a ferrule terminal with an insulation sleeve to crimp the cables because such cable conductors could become loose.

Recommended ferrule terminals for signal cables

(made by Phoenix Contact)

Unit: mm (in)

	Model Number	a	b	l <sub>1</sub>	l <sub>2</sub>
①	AI 0,34-8 TQ	2 (0.08)	0.8 (0.03)	12.5 (0.49)	8 (0.31)
②	AI 0,5-8 WH	2.5 (0.1)	1.1 (0.04)	14 (0.55)	8 (0.31)

Recommended ferrule terminals for DC power supply cables

(made by Phoenix Contact)

Unit: mm (in)

	Model Number	a	a <sub>1</sub>	a <sub>2</sub>	b	l <sub>1</sub>	l <sub>2</sub>
③	AI 1,5-8 BK	3.4 (0.31)	—	—	1.8 (0.07)	14 (0.55)	8 (0.31)
④	AI-TWIN 2 x 1,5-8 BK	—	6.6 (0.26)	3.6 (0.14)	2.3 (0.09)	16 (0.63)	8 (0.31)

Crimping tool: CRIMPFOX 10S (made by Phoenix Contact)

### [Cable sheath to trim]

Solid cable and stranded cable

Shielded cable

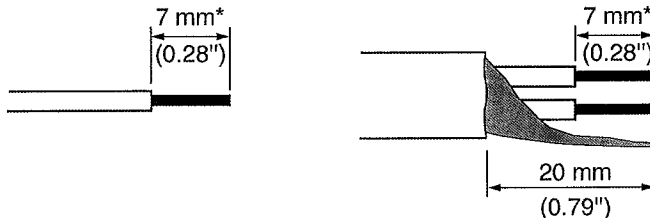

\* Expose 8 mm (0.31") or more when using the above ferrule terminal, and cut off an extra conductor protruding from the sleeve.

### [Wiring procedures]

#### Step 1. Wiring the supplied removable terminal plug.

- 1-1. Loosen the terminal screws to insert the wire.
- 1-2. Tighten the terminal screws.  
Ensure that the wire does not break free when pulled. If the wire does pull free, repeat the connection procedure from the start.

#### Step 2. Insert the wired terminal plug into the corresponding terminal block in the unit's rear panel.

### Notes

- Do not reverse **Steps 1** and **2** above. Poor contact may result if force is applied to the unit's internal circuit board pins while the terminal screws are being tightened.
- When detaching the terminal plug, pull it straight out. Pulling it out at an angle may cause the terminal plug or terminal block to break.

[Recommended type of screwdriver with the following blade width]

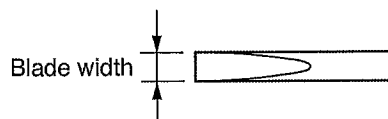

For DC power input terminal: About 3.5 mm (0.14") wide blade  
For other terminals: About 2.5 mm (0.1") wide blade

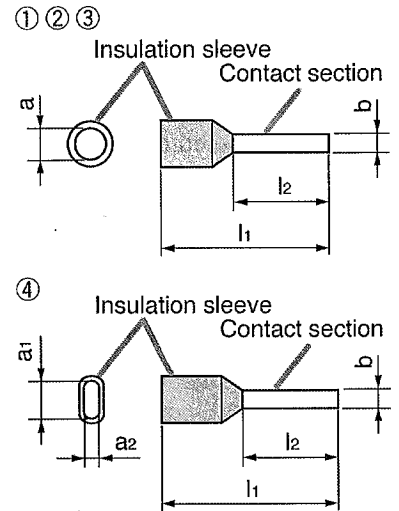

## 30. IF YOU HAVE ANY PROBLEMS

### 30.1. Troubleshooting

Symptom	Possible cause	Remedy
Power indicator not light. Power is not turned on.	Power is not supplied.	Supply power to the unit's AC adapter input terminal or DC power input terminal. <b>Note:</b> The unit is not equipped with a power switch.
Cannot play.	Memory card not inserted into the Memory card Slot A. (The Card error indicator is lit.)	Securely insert the memory card into the Memory card Slot A.
	The unit is placed in Maintenance mode. (The Maintenance indicator is lit.)	Quit the setting on the EV-700 Setting software or return all the switches of the DIP switch used for Maintenance to the OFF position.
	An error has occurred at the unit. ("Errxx" error code indication appears on the Status display.)	Refer to the Error list (See p. 98.), then follow the instructions.
	Unusable memory card is inserted.	Use the supplied memory card or the optional card which can be bought from your nearest TOA dealer.
	Line output terminals are not correctly connected.	Connect the Line output terminals correctly.
	Whole sound volume or program sound volume is set too low.	Adjust the whole sound volume and program sound volume for an appropriate volume level.
No sound output even when playback is started.	Line output terminals are not correctly connected.	Connect the line output terminals correctly.
	Whole sound volume or program sound volume is set too low.	Adjust the whole volume or program sound volume for an appropriate volume level.
	Output destinations are not correctly set.	Check the Program setting's output destinations. (See the EV-700 Setting software instruction manual.)
	Broadcast is set to OFF in the Broadcast priority level setting.	Check the Broadcast priority level setting. (See the EV-700 Setting software instruction manual.)
Playback not start even if you close the Contact-activated input terminal.	Contact-activated input terminal is not correctly connected.	Check connection of the Contact-activated input terminal. (See p. 28, "ACTIVATING OPERATION BY WAY OF EXTERNAL CONTROL.")
	No phrase is registered to the program corresponding to the closed Contact-activated input terminal number.	Record an audio source to the phrase registered in the program or register the phrase using the EV-700 Setting software.
	Control function "Direct" or "Binary" is not correctly set as intended.	Check which function has been set on the EV-700 Setting software. (When set to Binary control function, activate playback by way of make contacts in combination with the Contact-activated input terminal and Contact control input terminal.) (See p. 30, EV-700 Setting software instruction manual.)

Symptom	Possible cause	Remedy
Cannot start recording.	The audio source has already been registered to the phrase to which you want to record.	Delete the audio source registered to the phrase to which you want to record, then start recording. (See p. 25.)
	Memory card is full.	Delete unnecessary audio sources, then start recording.
Volume level is too small or no sound is heard even if recorded sound playback is started.	Microphone is not correctly connected to the microphone input jack or external audio player to the line input terminal at the time of recording.	Correctly connect the microphone to the microphone input jack or external audio player to the line input terminal, then start recording.
	Input level from the external audio player to the unit is too small at the time of recording.	Adjust sound volume of the external audio player for an appropriate volume level. (See p. 22, "Recording to Phrase.")
	Audio signals are entered to the input not intended for recording.	Stop audio signals from entering such input. Also, set the volume knob of such input to the minimum position.
	Program sound volume is decreased.	Check the program sound volume using the EV-700 Setting software. Or, turn on the AGC using the EV-700 Setting software and the sound volume is automatically adjusted. (See the EV-700 Setting software instruction manual.)
Volume level is too small when playing the audio signals transferred by the EV-700 Setting software.	Sound volume of wav file is decreased.	Adjust the sound volume of wav file first, then transfer the file to the unit. Or, turn on the AGC using the EV-700 Setting software and the playback sound volume is automatically adjusted. (See the EV-700 Setting software instruction manual.)
	Program sound volume is decreased.	Check the program sound volume using the EV-700 Setting software. Or, turn on the AGC using the EV-700 Setting software and the playback sound volume is automatically adjusted. (See the EV-700 Setting software instruction manual.)
Cannot make external input broadcasts.	Higher-priority broadcast is currently being made.	Check the broadcast priority level. (See the EV-700 Setting software instruction manual.) Higher-priority broadcast of the Microphone broadcast, Line input broadcast, and Normal broadcast is made preferentially. Lower-priority broadcast is not made while higher-priority broadcast is being made.
	Microphone is not correctly connected to the Microphone input jack or external audio player to the Line input terminal.	Correctly connect the microphone to the Microphone input jack or external audio player to the Line input terminal.
	Input level from the external audio player to the unit is decreased.	Adjust the sound level of the external audio player for an appropriate level. (See p. 83, "Making the Line input broadcast.") Adjust the input volume control while monitoring the level meter.



Symptom	Possible cause	Remedy
Busy signal not output.	Contact control output terminals are not correctly connected.	Connect the Contact control output terminals correctly.
	Control output and program playback busy output are not correctly set.	Set the control output and program playback busy output using the EV-700 Setting software. (See the EV-700 Setting software instruction manual.)
Hiss noise is broadcast.	Microphone input volume control or Line input volume control is turned fully clockwise.	Turn the volume controls fully counterclockwise when these input terminals are not used.
	The priority level set to Microphone input broadcast or Line input broadcast is higher than that set to Normal broadcast.	Set the lower-priority level to Microphone input broadcast or Line input broadcast than Normal broadcast.
Buzzing noise is broadcast.	Functional earth terminal is not grounded.	Ground the Functional earth terminal.
EV-700 and a PC not placed online even when connecting between the two and activating the EV-700 Setting software.	LAN cable is not correctly connected.	Check if LAN cable is correctly connected. The LINK/ACT indicator lights or flashes when the cable is correctly connected. In the case of communication via the network, check if cables connected to the switching hub are appropriate ones and they are connected to the correct port. (See p. 92.)
	Network setting is not performed correctly.	See the EV-700 Setting software instruction manual. Or, consult your network administrator.
The "Errxx" indication appears on the Status display.	An error has occurred.	Confirm the remedy in the Error list. (See p. 98.)

### 30.2. Error List

When an error occurs in the EV-700, the error code as shown below appears on the Status display.

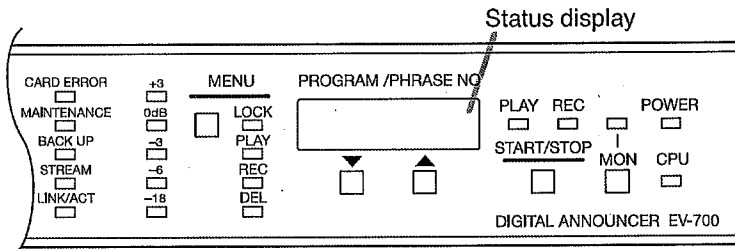

Error cord	Error description	Remedy
Err01	A different command is received during command processing at the unit. Or an instruction command or contact activation command is executed under the condition that it is not accepted because other function is operating, such as when playback is started during recording.	<ul style="list-style-type: none"> <li>• Check if there is an error in operation such that the device operation is executed from the EV-700 Setting software while the unit is not in executable state. Check the condition of the unit, then retry.</li> <li>• Check if contact activation is made rightly from the external control device.</li> </ul>
Err02	An instruction command or contact activation command is executed in inexecutable mode such as when playback is started in Maintenance mode.	
Err03	Command or contact activation executable only in the Emergency broadcast mode is executed. Or, command or contact activation not executable in the Emergency broadcast mode is executed.	
Err04	In other cases stated above, an instruction command or contact activation command is executed in the inexecutable state. (Example) Stop instruction is executed by the Playback stop command during program playback made by Level signal input activation at the contact terminal.	
Err10	Memory card is not inserted.	Insert a memory card.
Err11	Memory card B is not inserted.	Insert a memory card into the slot B.
Err12	Insufficient free space on the memory card	Check the memory card, then erase the unnecessary files.
Err13	Memory card is not formatted (initialized) with FAT16/FAT32.	Reformat the memory card. The memory card format is FAT16 or FAT32.
Err14	Device setting file does not exist on the Memory card A or failed to open the device setting file.	Check if the device setting file is stored on the memory card inserted into the slot A.
Err15	Firmware file does not exist on the Memory card B or failed to open the firmware file.	Check if the firmware file for update is stored on the memory card inserted into the slot B.
Err16	For the channel not to output program playback busy, setting is made to output busy signal during program playback according to the program playback busy information of the project* file.	Confirm that there is no difference between the program playback busy channels set at the device setting and that set to each program of the project*.
Err17	An error not corresponding to other errors related to memory card is detected.	Memory card error may occur. Check the memory card error with the PC. If the error still remains, it may be eliminated by reformatting the memory card. But note that all saved data is erased once the card is reformatted.
Err20	Error occurred when opening the table file.	<ul style="list-style-type: none"> <li>• There may be abnormalities in the project* configuration. Check the contents using the EV-700 Setting software in the case of the project* created using the EV-700 Setting software. Consult the TOA dealer if the error occurred in the project* on the memory card supplied with the unit.</li> <li>• Memory card error may occur. Check the memory card error with the PC. If the error still remains, it may be eliminated by reformatting the memory card. But note that all saved data is erased once the card is reformatted.</li> </ul>

\* A collection of files necessary for the EV-700 to broadcast. For the details, read the EV-700 Setting software instruction manual.

Error cord	Error description	Remedy
Err21	Error occurred when reading the table file.	Memory card error may occur. Check the memory card error with the PC. If the error still remains, it may be eliminated by reformatting the memory card. But note that all saved data is erased once the card is reformatted.
Err22	Number assigned to the table is out of range. (Except the setting value of the program)	There may be abnormalities in the project* setting. Check the setting contents using the EV-700 Setting software in the case of the project* created using the EV-700 Setting software. Consult the TOA dealer if the error occurred in the project* on the memory card supplied with the unit.
Err23	Setting value of the program table is out of range.	
Err24	There is a table file in the format not available with the unit.	
Err25	Error occurred when opening the audio file.	<ul style="list-style-type: none"> <li>• There may be abnormalities in the project* configuration. Check the contents using the EV-700 Setting software in the case of the project* created using the EV-700 Setting software. Consult the TOA dealer if the error occurred in the project* on the memory card supplied with the unit.</li> <li>• Memory card error may occur. Check the memory card error with the PC.</li> </ul> If the error still remains, it may be eliminated by reformatting the memory card. But note that all saved data is erased once the card is reformatted.
Err26	Error occurred when reading the audio file.	Memory card error may occur. Check the memory card error with the PC. If the error still remains, it may be eliminated by reformatting the memory card. But note that all saved data is erased once the card is reformatted.
Err27	There is an audio file in the format not usable at the unit. There is an audio file of which sampling frequency is different from that of the project*.	<ul style="list-style-type: none"> <li>• There may be abnormalities in the project* configuration. Check the contents using the EV-700 Setting software in the case of the project* created using the EV-700 Setting software. Consult the TOA dealer if the error occurred in the project* on the memory card supplied with the unit.</li> <li>• Memory card error may occur. Check the memory card error with the PC.</li> </ul> If the error still remains, it may be eliminated by reformatting the memory card. But note that all saved data is erased once the card is reformatted.
Err28	Error occurred in deletion process.	Memory card error may occur. Check the memory card error with the PC. If the error still remains, it may be eliminated by reformatting the memory card. But note that all saved data is erased once the card is reformatted.
Err29	Error occurred in recording process.	Memory card error may occur. Check the memory card error with the PC. If the error still remains, it may be eliminated by reformatting the memory card. But note that all saved data is erased once the card is reformatted.
Err30	There is a discrepancy in the contents between the memory cards A and B.	Check the contents on the memory cards A and B.
Err31	There is a discrepancy in the tables between the memory cards A and B.	
Err32	Session is timed out when comparing the card data.	
Err33	All deletion of files on the memory card is failed.	Memory card error may occur. Check the memory card error with the PC. If the error still remains, it may be eliminated by reformatting the memory card. But note that all saved data is erased once the card is reformatted.
Err34	Failed to read firmware file.	
Err35	Failed to update firmware.	Consult the TOA dealer where the unit was purchased if this error occurred.

\* A collection of files necessary for the EV-700 to broadcast. For the details, read the EV-700 Setting software instruction manual.

Error cord	Error description	Remedy
Err36	Firmware file is invalid.	<ul style="list-style-type: none"> <li>There may be abnormalities in the firmware file in use. Consult the TOA dealer where the unit was purchased.</li> <li>Memory card error may occur. Check the memory card error with the PC.</li> </ul> <p>If the error still remains, it may be eliminated by reformatting the memory card. But note that all saved data is erased once the card is reformatted.</p>
Err37	History file open error.	<p>Memory card error may occur. Check the memory card error with the PC.</p> <p>If the error still remains, it may be eliminated by reformatting the memory card. But note that all saved data is erased once the card is reformatted.</p>
Err38	Failed to open the History file.	
Err40	Received command is invalid.	<p>Invalid control data may be transmitted to the unit from the EV-700 Setting software. When an error frequently occurs, consult the TOA dealer where the unit was purchased.</p>
Err41	Program of the designated number does not exist.	
Err42	Out-of-range value is designated.	
Err43	Attempted to execute the 17th sequential storage.	
Err44	Abnormality is detected in the priority level designation.	
Err45	Attempted to set abnormal setting values. Abnormal setting value is confirmed by the Flash, setting file, or setting value.	
Err46	Time-out occurs during the middle of command reception.	<p>Control data may be transmitted to the unit from the EV-700 Setting software at an unintended timing. When an error frequently occurs, consult the TOA dealer where the unit was purchased.</p>
Err47	Other command is received before responding to the received command. Other command (except the Command control start command and the Command control end command) is received before receiving the Command control start command.	
Err50	RAM error is detected.	<p>The unit's failure may occur. Consult the TOA dealer where the unit was purchased.</p>
Err51	FRAM error is detected.	
Err52	Flash error is detected.	
Err53	RTC is reset.	<p>The unit's clock is reset. Reset the clock with the EV-700 Setting software.</p> <p>When an error frequently occurs, consult the TOA dealer where the unit was purchased.</p>
Err60	Attempted to make recording to the phrase number where a phrase is registered. Attempted to make recording in the state that a file with serial No. 99999 exists.	<p>Make recording by selecting an unregistered phrase number or after a registered phrase has been deleted. Recording is not possible when the serial number of the recorded Audio file reaches 99999. (As the serial number is automatically assigned to the phrase at the time of recording on a day-to-day basis, this error occurs only when the number of recording per day becomes 100000 or more.)</p>
Err61	Attempted to delete the phrase number to which no phrase is registered.	<p>To delete the phrase, select the desired phrase number to which phrase is registered.</p>
Err62	Recording files reached the upper limit of the WAV file in time.	<p>Perform recording by reducing the recording time. (The maximum recording time for a single phrase is 2 hours.)</p>
Err70	Instruction value used inside the unit's firmware is abnormal.	<p>The unit's firmware may be malfunctioning. Consult the TOA dealer where the unit was purchased.</p>

## 31. ABOUT THE EV-700'S STATE AND INPUT/OUTPUT

Following 3 points are set for the EV-700 as shown in the table below depending on the EV-700's state (Mode and operation type).

- (1) Audio source that can be output
- (2) Output destination
- (3) Display content in the level meter

EV-700's state		Audio source that can be output*1			Output destination terminal		Display content in the level meter
Mode	Operation type	Memory card audio source	Microphone input	Line inputs (Front/Rear)	Line outputs 1 and 2	Headphones	
Lock	Standby	-	✓	✓	✓	✓	Input level*2 of Microphone input or Line input
	Playback*3	✓	✓	✓	✓	✓	Output level of memory card audio sources Input level*2, 4 of the Microphone input or Line input
	Recording	-	✓	✓	-	✓	Input level of the Microphone input or Line input
	Deletion	-	-	-	-	-	No indication
Playback	Standby	-	-	-	-	-	No indication
	Playback	✓	-	-	✓	✓	Output level of memory card audio sources Input level*2, 4 of the Microphone input or Line input
	Monitor playback	✓	-	-	-	✓	Output level of memory card audio sources
Recording	Standby	-	✓	✓	-	✓	Input level of the Microphone input or Line input
	Recording check Count down During recording	-	✓*5	✓*5	-	✓	Input level of the Microphone input or Line input
	Monitor playback	✓	-	-	-	✓	Output level of memory card audio sources
Deletion	Standby	-	-	-	-	-	No indication
	Deletion check During deletion	-	-	-	-	-	No indication
	Monitor playback	✓	-	-	-	✓	Output level of memory card audio sources
Emergency	Emergency playback	✓	-	-	✓	✓	Output level of memory card audio sources
	R.E.M. playback (during recording)	-	✓*5	✓*5	-	✓	Input level of the Microphone input or Line input
	R.E.M. playback (during playback)	✓	-	-	✓	✓	Output level of memory card audio sources

\*1 You can broadcast any one of the memory card audio source, Microphone input, and Line input preferentially if you set the broadcast priority level. Mixed audio sources cannot be broadcast.

\*2 Output level and input level are the same.

\*3 "Playback in Lock mode" will be made when playback start is triggered by the contact or command in Lock mode.

\*4 Displays the audio source level being broadcast.

\*5 The microphone input or the line input is recorded.

When the microphone and line inputs are simultaneously input, one with the higher broadcast priority assigned is recorded.

## 32. PRERECORDED AUDIO FILE LIST

Prerecorded audio files are contained in the root folder "WORDSAMPLE" of the supplied memory card. As they are classified into the following storage folders according to purpose of use, use them according to the intended purpose.

### Notes

- Never use the prerecorded audio files with other products than the EV-700. They can only be used with the EV-700.
- Duplication or diversion of the prerecorded audio files is prohibited without permission of the right holder, except for making backup copies.

Storage folder name	Description	File name	Contents	Time (Sec)	Factory-preset program No.
melody	Melodies used for time signals	M01_original.wav	Original Ambient Music	57	-
		M02_jeji.wav	Dvořák Symphony No.9 "From The New World" 2nd Movement	172	-
		M03_nobara.wav	Schubert Wild Rose (Heidenröslein)	51	-
		M04_yuyakekoyake.wav	When The Sun Begins To Fall	58	-
		M05_hotarunohikari.wav	Auld Lang Syne	194	-
		M06_gohannouta.wav	I've Been Working On The Railroad	61	-
		M07_schubert_lullaby.wav	Schubert Lullaby	70	-
		M08_nanatsunoko.wav	Seven little babies	169	-
		M09_furusato.wav	My country home	59	-
		M10_omoido.wav	Memory	28	-
chime	Chime tones used for time signals and for catching-attention before and after announcements	C01_westminster_normal.wav	Westminster chime (normal)	35	-
		C02_westminster_fast.wav	Westminster chime (fast)	27	-
		C03_westminster_slow.wav	Westminster chime (slow)	43	-
		C04_4note_up.wav	Ascending 4-tone chime	5	P008
		C05_4note_down.wav	Descending 4-tone chime	5	P002
		C06_first_bell.wav	First bell	15	-
		C07_2note.wav	2-tone chime	4	P001
		C08_gong.wav	Gong	4	P003
		C09_4note_up_nx.wav	Ascending 4-tone chime (normal)	4	-
		C10_4note_up_slow_nx.wav	Ascending 4-tone chime (slow)	7	-
		C11_4note_down_nx.wav	Descending 4-tone chime (normal)	4	-
		C12_4note_down_slow_nx.wav	Descending 4-tone chime (slow)	7	-
		C13_buzzer.wav	Buzzer	21	-
emergency	Alarm tones used to alert people to emergency situations	E01_keihou1.wav	Alarm #1	31	-
		E02_keihou2.wav	Alarm #2	31	-
		E04_motor_siren.wav	Motor siren	21	-
		E06_yelp.wav	Yelp	31	P004
test	Test sound sources at equipment installation	T01_1khz_0dB.wav	Test sound source #1 (1 kHz, 0 dB)	60	-
		T02_1kHz_-20dB.wav	Test sound source #2 (1 kHz, -20 dB)	60	-
		T03_2kHz_0dB.wav	Test sound source #3 (2 kHz, 0 dB)	60	-
		T04_pinknoise.wav	Test sound source #4 (pink noise)	60	-
		T05_silent.wav	Test sound source #5 (silence)	60	-
announce (fire)	Announcements to be made when a fire occurs	A_fire01.wav	Attention please. The fire alarm is indicating a fire. We're now investigating the cause. Please wait for a further information.	11	P005
		A_fire02.wav	There is a fire. Please evacuate as quickly as possible.	5	P006
		A_fire03.wav	Attention please. A few minutes ago, we announced there may be a fire. However, this was a false alarm. Once again, there is no fire.	12	P007

### 33. SPECIFICATIONS

Power Source	Supplied from an external 24 V DC (21.6 – 26.4 V)/400 mA power supply, Removable terminal block (2 pins) or from an optional AD-246 AC adapter
Power Consumption	10 W
Wave Format	44.1 kHz/32 kHz sampling rate, 16 bit PCM method, WAV file (monaural)
Sound Source Rewriting Method	LAN data transfer/Analog recording/ Direct write to memory card using the EV-700 setting software
Audio Input	MIC: –55 dB*1 (microphone input volume control in maximum position), 600 Ω, unbalanced, ϕ6.3 phone jack (2P) LINE (rear): –20 dB*1 (line input volume control in maximum position), 10 kΩ, unbalanced, Removable terminal block (12 pins) LINE (front): –29 dB*1 (line input volume control in maximum position), 10 kΩ, unbalanced, RCA pin jack
Audio Output	LINE 1, 2: 0 dB*1, 600 Ω, unbalanced, Removable terminal block (12 pins) Headphones: 0 dB*1, 100 Ω, monaural, ϕ3.5 mini jack (3P)
Frequency Response	20 Hz – 20 kHz ±3 dB (1 kHz) 50 Hz – 14 kHz ±3 dB (IT-450 mounted, 1 kHz)
Distortion	0.3 % or less (1 kHz, rated output)
Storage Media	Compatible with CompactFlash™ specification Memory card
Number of Mountable Memory cards	2 (1 Memory card containing preset sound sources is supplied.) Backup operation available when 2 cards are mounted.
Number of Recordable Phrases	32768
Maximum Recording Time	About 3 hours (at 44.1 kHz sampling rate) or about 4 hours (at 32 kHz sampling rate)
Audio Output Method	Single channel monaural
Number of Playback Program	Direct mode: 16 programs Binary mode: 256 programs 1 emergency message takes precedence over the above programs and is played back. R.E.M. (Recording Endless Message) playback*2 can be performed.
Control Input	Activations 1 – 16, playback, pause, recording, delete/clear, emergency playback, emergency recording, emergency pause No-voltage make contact input, pulse make length: 50 ms or more, open voltage: 30 V DC, short-circuit current: 10 mA, Removable terminal block (16 pins)
Control Output	Shorting outputs 1 – 8 (busy), Error: contact capacity: 30 V DC, 0.5 A, Removable terminal block (8 pins)
<b>Network</b>	
Network I/F	100BASE-TX
Network protocol	TCP/IP, UDP, HTTP, FTP
Connector	RJ45 connector
Operating Display	7-segment LED, 5 digits
Operating Temperature	0 to 40 °C (32 to 122 °F)
Operating Humidity	90 %RH or less (no condensation)
Finish	Panel: Aluminum, black, 30 % gloss, paint Case: Pre-coated steel plate, black, 30 % gloss
Dimensions	420 (w) x 44 (h) x 222 (d) mm (16.54" x 4.06" x 8.74")
Weight	2.4 kg (5.29 lb)

\*1 0 dB = 1 V

\*2 An emergency broadcast function that repeatedly plays the sound source recorded on the spot with the highest priority in case of an emergency situation.

#### Notes

- Line output can be converted to balanced type using an optical IT-450 transformer. For the converting method, consult your nearest TOA dealer.
- The design and specifications are subject to change without notice for improvement.

• **Accessories**

Memory card (Containing prerecorded audio files) .....	1
Removable terminal plug (2 pins) .....	1
Removable terminal plug (8 pins) .....	2
Removable terminal plug (16 pins) .....	2
Removable terminal plug (12 pins) .....	2
Rubber foot .....	4
Machine screw M3 x 12 (for fixing the front cover) .....	2
CD .....	1

• **Optional products**

AC adapter:	AD-246
Rack mounting bracket:	MB-15B