



PA AMPLIFIERS

OPERATING INSTRUCTIONS

A-2060 CU

A-2120 CU

A-2240 CU

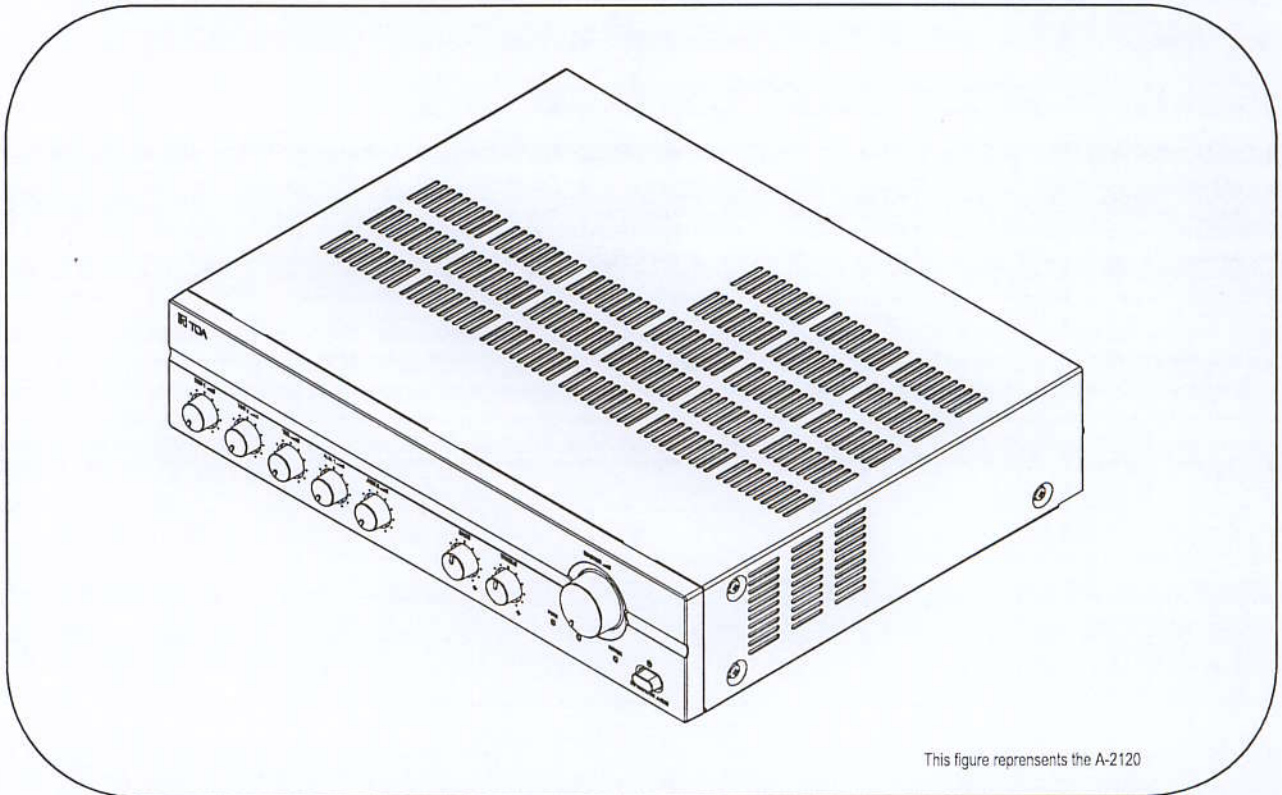

This figure represents the A-2120

Please follow the instructions in this manual to obtain the optimum results from this unit.
We also recommend that you keep this manual handy for future reference.

TOA Corporation

TABLE OF CONTENTS

1. IMPORTANT SAFETY INSTRUCTIONS.....	3
2. SAFETY PRECAUTIONS	3
3. GENERAL DESCRIPTION	5
4. FEATURES.....	5
5. NOMENCLATURE AND FUNCTIONS	
5.1 Front	6
5.2 Rear	6
6. CONNECTIONS	
6.1. Input Connections	7
6.2. Output Connections	8
6.3. Example of External Equipment Connections	9
7. MUTING FUNCTION	9
8. INSTALLATION	10
9. VOLUME CONTROL SETTINGS	10
10. BLOCK LEVEL DIAGRAM	10
11. DIMENSIONAL DIAGRAM	11
12. SPECIFICATIONS	12

1. IMPORTANT SAFETY INSTRUCTIONS

- Read these instructions.
- Keep these instructions.
- Heed all warnings.
- Follow all instructions.
- Do not use this apparatus near water.
- Clean only with dry cloth.
- Do not block any ventilation openings. Install in accordance with the manufacture's instructions.
- Do not install near any heat sources such as radiators, heat registers, stoves, or other apparatus (including amplifiers) that produce heat.
- Do not defeat the safety purpose of the polarized or grounding-type plug. A polarized plug has two blades with one wider than the other. A grounding type plug has two blades and a third grounding prong. The wide blade or the third prongs are provided for your safety. If the provided plug does not fit into your outlet, consult an electrician for replacement of the obsolete outlet.
- Protect the power cord from being walked on or pinched particularly at plugs, convenience receptacles, and the point where they exit from the apparatus.
- Only use attachments/accessories specified by the manufacturer.
- Use only with the cart, stand, tripod, bracket, or table specified by the manufacturer, or sold with the apparatus.
- When a earth is used, use caution when moving the cart/apparatus combination to avoid injury from tip-over.
- Unplug this apparatus during lightning storms or when unused for long periods of time.
- Refer all servicing to qualified service personnel. Servicing is required when the apparatus has been damaged in any way, such as power-supply cord or plug is damaged, Liquid has been spilled or objects have fallen into the apparatus, the apparatus has been exposed to rain or moisture, does not operate normally, or has been dropped.



2. SAFETY PRECAUTIONS

- Before installation or use, be sure to carefully read all the instructions in this section for correct and safe operation.
- Be sure to follow all the precautionary instructions in this section, which contain important warnings and/or cautions regarding safety.
- After reading, keep this manual handy for future reference.

Safety Symbol and Message Conventions

Safety symbols and messages described below are used in this manual to prevent bodily injury and property damage which could result from mishandling.

Before operating your product, read this manual first and understand the safety symbols and messages so you are thoroughly aware of the potential safety hazards.



The exclamation point within an equilateral triangle is intended to alert the user to the presence of important operation and maintenance (servicing) instruction in the literature accompanying the appliance.



WARNING

Indicates a potentially hazardous situation which, if mishandled, could result in death or serious personal injury.

When Installing the Unit

- **WARNING:** Do not expose the unit to rain or an environment where it may be splashed by water or other liquids, as doing so may result in fire or electric shock.
- Use the unit only with the voltage specified on the unit. Using a voltage higher than that which is specified may result in fire or electric shock.
- Do not cut, kink, otherwise damage nor modify the power supply cord. In addition, avoid using the power cord in close proximity to heaters, and never place heavy objects -- including the unit itself -- on the power cord, as doing so may result in fire or electric shock.
- Avoid installing or mounting the unit in unstable locations, such as on a rickety table or a slanted surface. Doing so may result in the unit falling down and causing personal injury and/or property damage.
- The terminals marked with the symbol  are hazardous live. The external wiring to these terminals requires installation by an instructed person.
- The apparatus shall be connected to a mains socket outlet with a protective earthing connection.
- The socket-outlet shall be installed near the equipment and the plug shall be easily accessible.

When the Unit is in Use

- Should the following irregularity be found during use, immediately switch off the power, disconnect the power supply plug from the AC outlet and contact your nearest TOA dealer. Make no further attempt to operate the unit in this condition as this may cause fire or electric shock.
 - If you detect smoke or a strange smell coming from the unit.
 - If water or any metallic object gets into the unit.
 - If the unit falls, or the unit case breaks.
 - If the power supply cord is damaged (exposure of the core, disconnection, etc.)
 - If it is malfunctioning (no tone sounds.)
- To prevent a fire or electric shock, never open no remove the unit case as there are high voltage components inside the unit. Refer all servicing to you nearest TOA dealer.
- Do not place cups, bowls, or other containers of liquid or metallic objects on top of the unit. If they accidentally spill into the unit, this may cause a fire or electric shock.



CAUTION

Indicates a potentially hazardous situation which, if mishandled, could result in moderate or minor personal injury, and/or property damage.

When Installing the Unit

- Never plug in nor remove the power supply plug with wet hands, as doing so may cause electric shock.
- When unplugging the power supply cord, be sure to grasp the power supply plug; never pull on the cord itself. Operating the unit with a damaged power supply cord may cause a fire or electric shock.
- Do not block the ventilation slots in the unit's cover. Doing so may cause heat to build up inside the unit and result in fire.
- Avoid installing the unit in humid or dusty locations, in locations exposed to the direct sunlight, near the heaters, or in locations generating sooty smoke or steam as doing otherwise may result in fire or electric shock.
- To avoid electric shocks, be sure to unplug the unit's power supply cord when connecting speakers.
- Be sure to follow the instructions below when rack-mounting the unit. Failure to do so may cause a fire or personal injury.
- Install the equipment rack on a stable, hard floor. Fix it with anchor bolts or take other arrangements to prevent it from falling down.

- When connecting the unit's power cord to an AC outlet, use the AC outlet with current capacity allowable to the unit.
- No rack-mounting screws are supplied with the unit. Separately prepare the appropriate screws for the rack.
- Keep the 2000 series amplifiers over 10 cm away from objects that may obstruct air flow to prevent the unit's internal temperature rise.

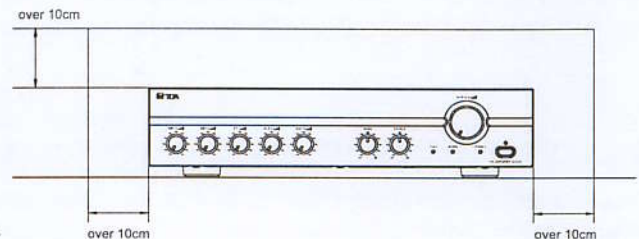

When the Unit is in Use

- Do not operate the unit for an extended period of time with the sound distorting. This is an indication of a malfunction, which in turn can cause heat to generate and result in a fire.
- Switch off the power, and unplug the power supply plug from the AC outlet for safety purposes when cleaning or leaving the unit unused for 10 days or more. Doing otherwise may cause a fire or electric shock.

An all-pole mains switch with a contact separation of at least 3 mm in each pole shall be incorporated in the electrical installation of the building.



The lighting flash with arrowhead symbol, within an equilateral triangle, is intended to alert the user to the presence of uninsulated "dangerous voltage" within the product's enclosure that may be of sufficient magnitude to constitute a risk of electric shock to persons.



ATTENTION

- L'appareil ne doit pas être exposé aux éclaboussures ou écoulements et tous objets remplis de liquide, tels que vases, ne doivent pas être sur l'appareil.

3. GENERAL DESCRIPTION

TOA's Basic Amplifiers A-2060, A-2120 and A-2240 are high performance mixer power amplifiers suited for broadcasting paging or background music in schools, offices, shops, factories, mosques, churches and large rooms.

4. FEATURES

- High durability, high reliability, and high performance.
- Two microphone inputs, one TEL input, two AUX inputs, and one recording output.
- Muting function with fixed mute depth (-30dB) and adjustable sensitivity.
- MIC 1 with phantom power switch for condenser microphones.
- TEL input is transformer balanced.
- Speaker output of constant voltage distribution system (25V or 70V) and low impedance (4Ω).
- Independent input volume controls and master volume control.
- Independent tone controls of boost and cut type for both high and low frequencies.
- Current limiter circuitry protects transistors, and the thermal protection circuitry prevents a failure due to overheat.
- All MIC inputs are electronically-balanced input.

5. NOMENCLATURES AND FUNCTIONS

5.1. Front

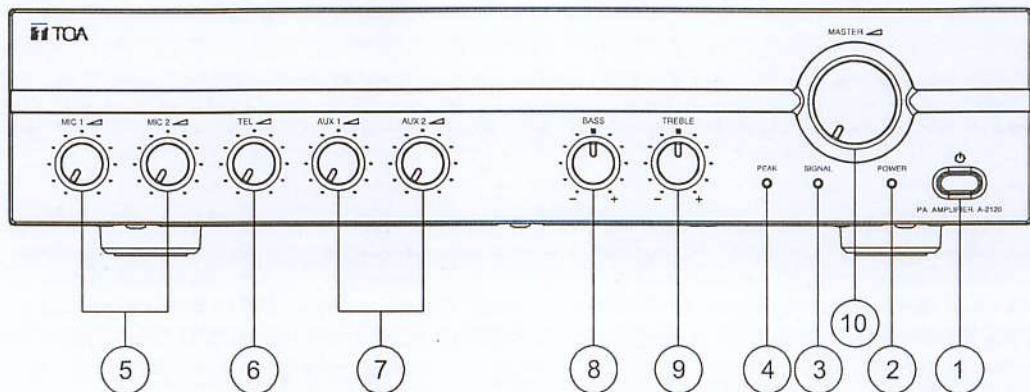

5.2. Rear

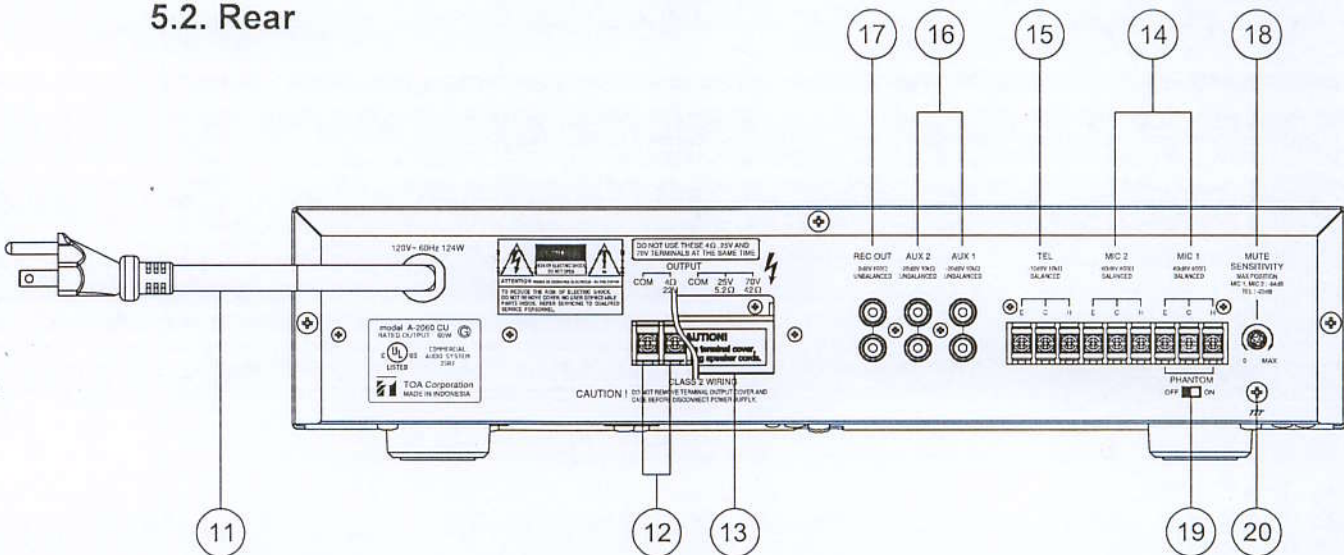

1. **Power Switch**
Press to turn ON the power.
Press again to turn the power STANDBY.
Disconnect the AC mains plug to shut the power OFF completely.
2. **Power Indicator**
Lights green when power is switched ON.
3. **Signal Indicator**
Lights green when power is switched ON, and indicates an output signal.
4. **Peak Indicator**
Lights red to indicate the output signal reaches the peak level, this indicates that sound is distorted. In such a case, adjust each volume control to reduce output level.
5. **Microphone Volume Control**
Adjusts the microphone level.
6. **TEL Volume Control**
Adjusts the TEL level.
7. **AUX Volume Control**
Adjusts the AUX level.
8. **Bass Control**
Adjusts bass response. Rotate clockwise to increase bass output, and counterclockwise to reduce it. The center position provides flat characteristics.
9. **Treble Control**
Adjusts treble response. Rotate clockwise to increase treble output, and counterclockwise to reduce it. The center position provides flat characteristics.

10. Master Volume Control

Adjusts the overall signal level.

11. AC Power Cord

Connects to an AC power source.

12. Output Terminals

Connect to speakers. When connecting speakers use only one of the speaker output terminals, low or high impedance.

13. Terminal Cover

To avoid electric shock by high voltage from output terminal, put back the terminal cover after connecting speaker cords.

14. MIC 1 and MIC 2 Inputs

• (Mic 1 : Screw Terminals)

-60 dB (1mV), 600 Ω, electronically balanced. Not only a dynamic microphone but also phantom powered microphone can connect with only this MIC 1 input.

• When it connects Dynamic Microphone, please set phantom switch in OFF by all means.

• (Mic 2 : Screw Terminals)

-60 dB (1mV), 600 Ω, electronically balanced.

15. TEL Input

• (Screw Terminals)

-10 dB (300mV), 10 kΩ, transformer isolated. Connect to LINE level audio output from TEL system or Paging interface adapter.

16. AUX 1 and AUX 2 Input Terminals

-20dB (100mV), 10kΩ, unbalanced. Monaural RCA pin jacks. Accept external equipment output signal.

17. Recording Output (REC OUT)

0dB (1V), 600Ω, unbalanced. Outputs all input signals before the master volume control. Connect to a cassette deck, etc when recording the broadcast contents.

18. Muting Sensitivity Control

The background music level is automatically reduced by 30 dB when priority function is operated. Adjusts the input threshold level of Mic1 and Mic2: 0 ~ -64dB, TEL: 0 ~ -23dB to control the mute function.

19. Phantom Switch

Selecting to ON position supplies power for condenser microphones from Mic 1. This phantom power is 21V DC.

Caution:

Be sure to select OFF position when using the microphone that can not be operated on phantom power. The sound will be distorted.

20. Ground Terminal

Connect to ground (earth) to avoid electric shock.

6. CONNECTIONS

6.1. Input Connections

- Mic 1 Connection (Screw Terminals).

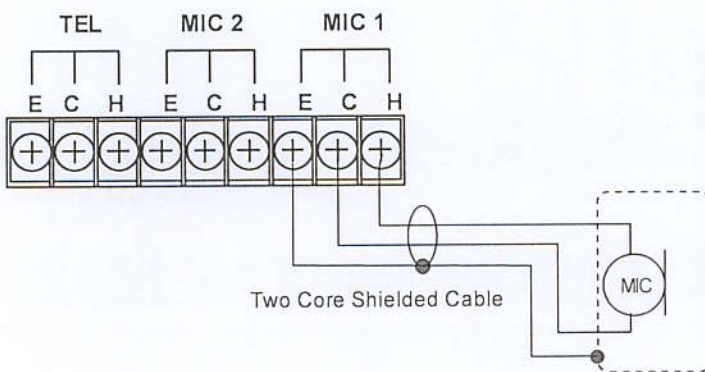

Phantom Switch Position

- In the case of Dynamic Microphone

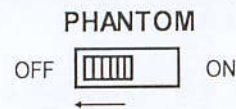

- In the case of Phantom Power Microphone

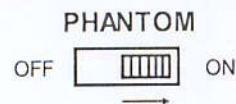

- Mic 2 & TEL Connections (Screw Terminals)

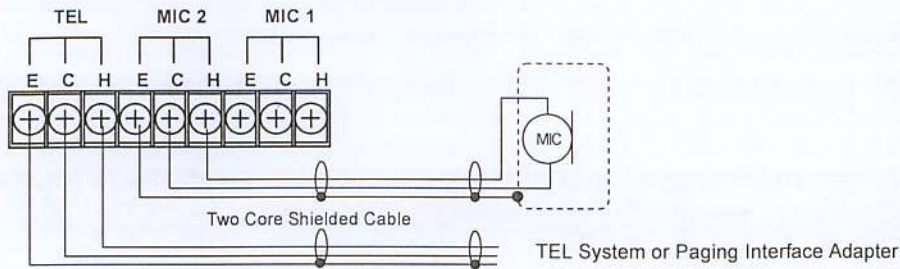

- AUX input Connections (RCA pin jack)

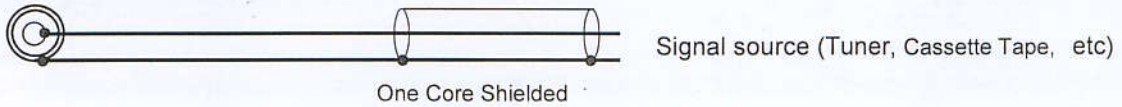

6.2. Output Connections

- Low Impedance Speaker

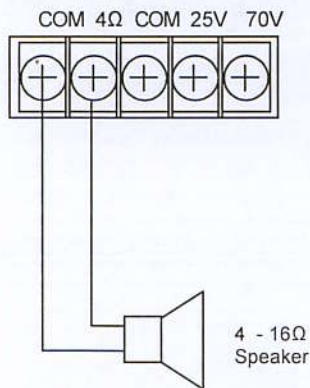

- 25V Line Speaker

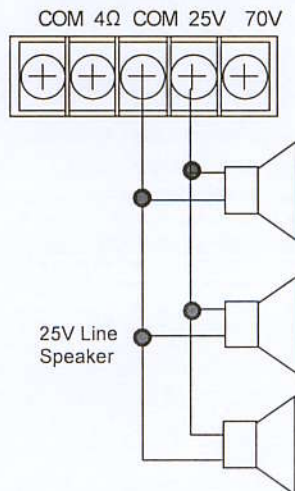

- 70V Line Speaker

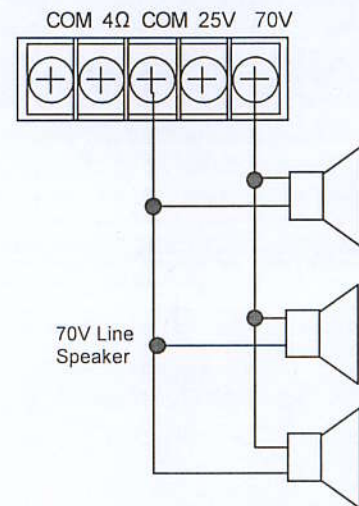

CAUTION!

- Tripartite the 4Ω, 25V and 70V terminals cannot be used at the same time.
- Impedances indicated at the terminal represent the total speaker system (load) impedances.

Total impedances of 70V line:

- 83Ω (A-2060)
- 42Ω (A-2120)
- 21Ω (A-2240)

Total impedances of 25V line:

- 10Ω (A-2060)
- 5.2Ω (A-2120)
- 2.6Ω (A-2240)



CAUTION

Be sure to attach the supplied terminal cover after connection completion.
Because high voltage is applied to the speaker terminals, never touch these terminals to avoid electric shock.

6.3. Example of External Equipment Connections

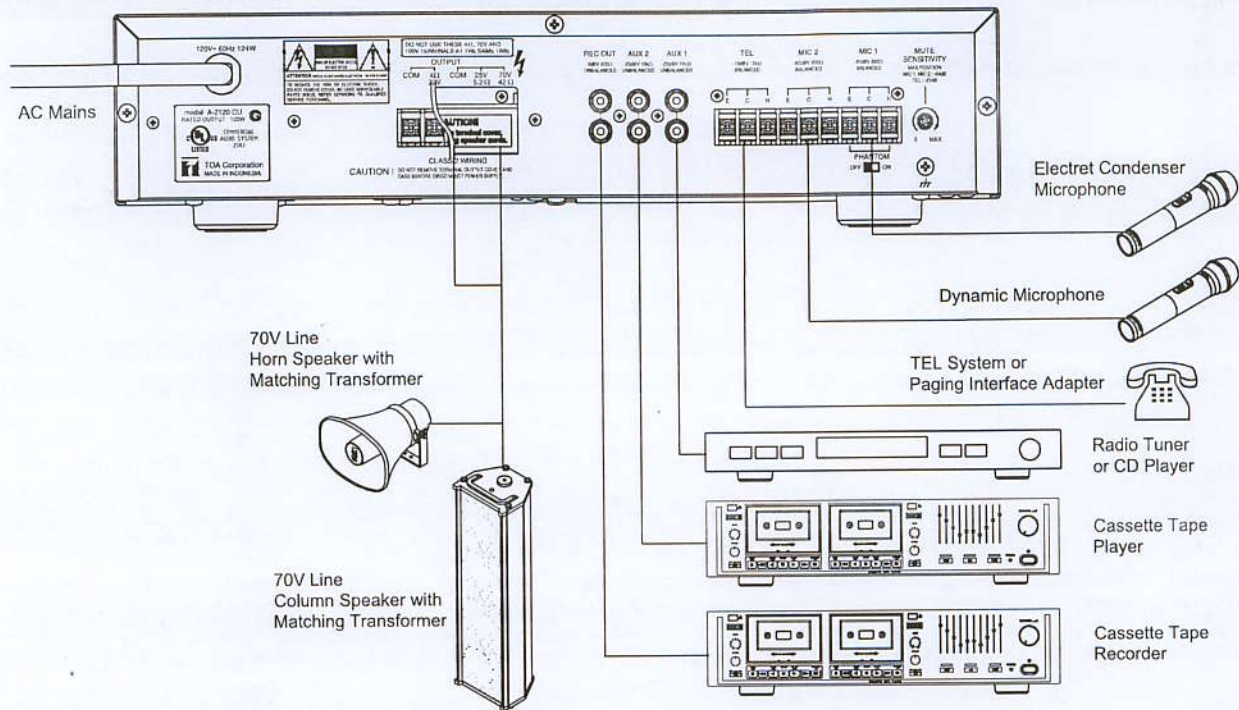

7. MUTING FUNCTION

Mic 1, Mic 2 and TEL inputs have a priority function and each mutes other inputs by the same priority level. When Mic 1 or Mic 2 or TEL input is used, it takes precedence and automatically reduces. The attenuation level is 30dB fixed at the factory. The sensitivity input level to operate the muting function is adjustable 0 to -64dB for Mic1 and Mic2 or 0 to -23dB for TEL, with the MUTE SENSITIVITY on the rear panel. If set to 0, the muting function is turned OFF.

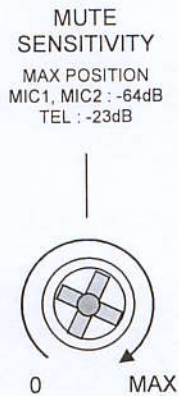

Remark: About Mute function.

- When signal is in Mic1, Mic2 or TEL, the mute circuit works immediately.
- When all the Mic1, Mic2, or TEL it disappears, it return to an old state about 3 seconds later.

8. INSTALLATION

Keep the unit's all sides over 10 cm (3.94 inches) away from object that may obstruct air flow to prevent the unit's internal temperature rise.

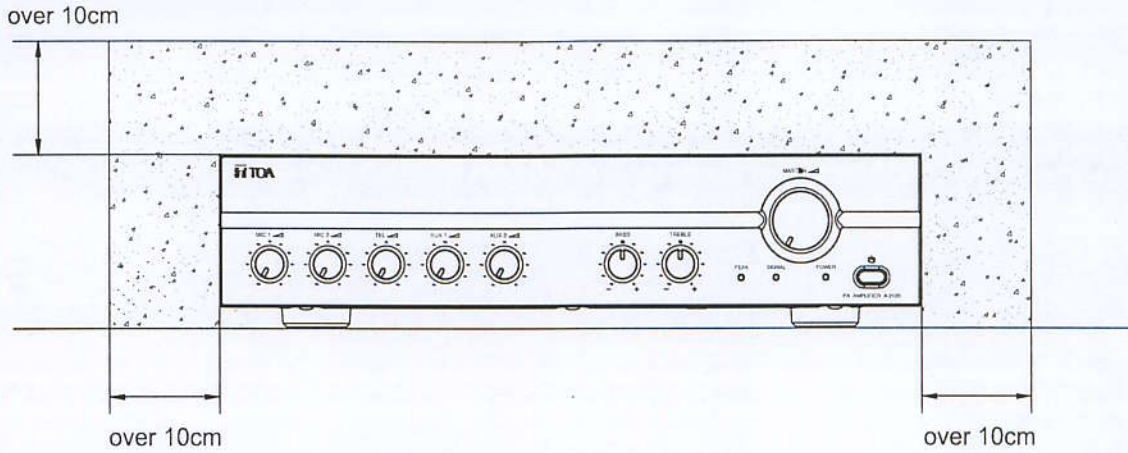

9. VOLUME CONTROL SETTINGS

Output levels are adjustable with individual volume controls. For music play or announcement, adjust the corresponding volume control so that the red peak indicator lights intermittently.

Note that the sound quality is downgraded when the peak indicator remains lit.

10. BLOCK & LEVEL DIAGRAM

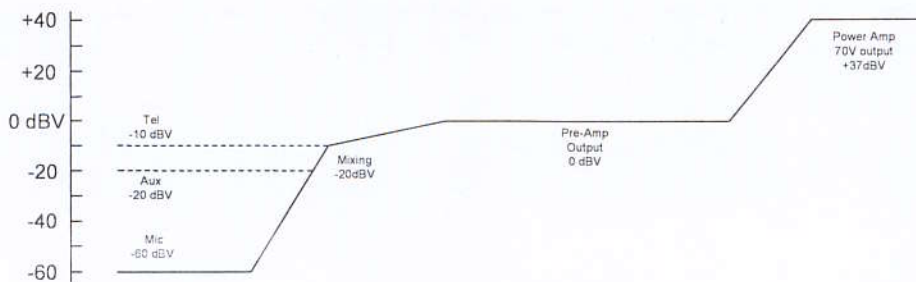
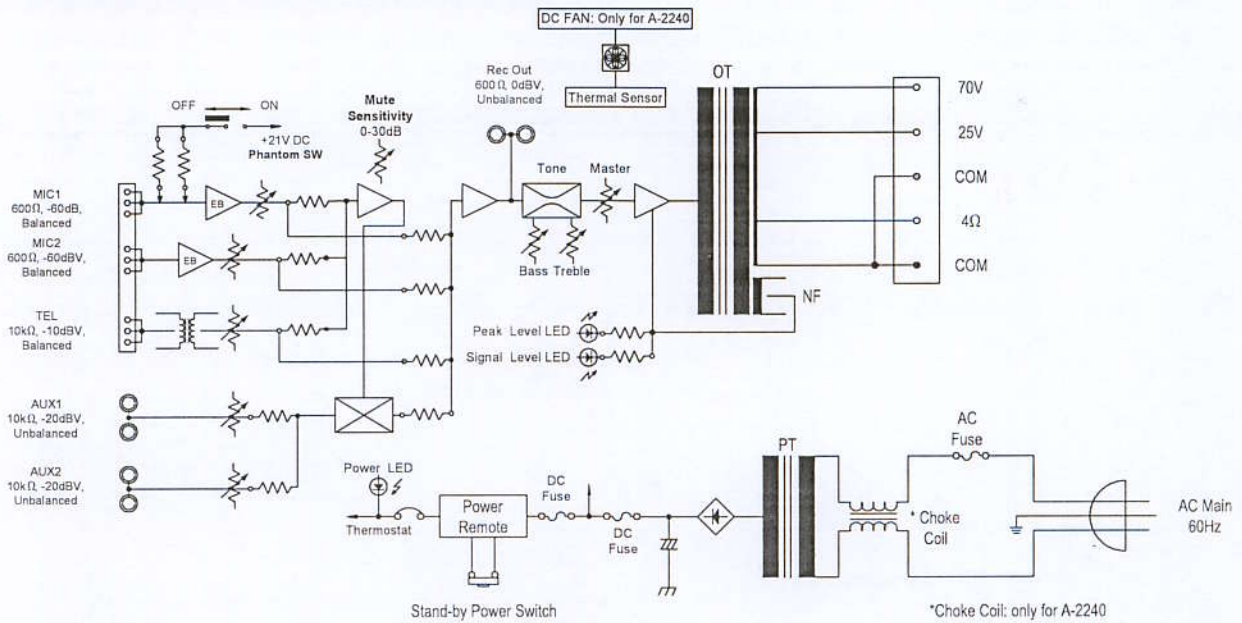

11. DIMENSIONAL DIAGRAM

- A-2060 CU

units: mm(inches)

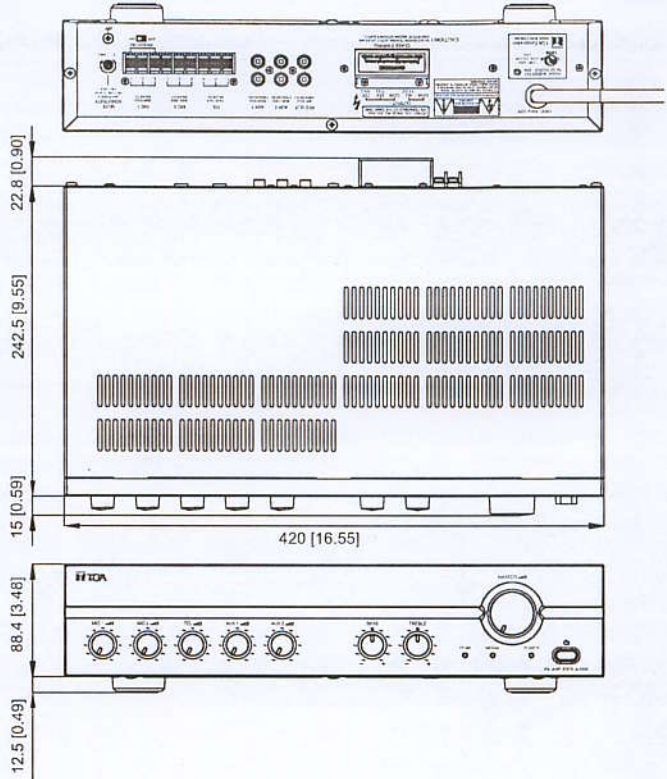
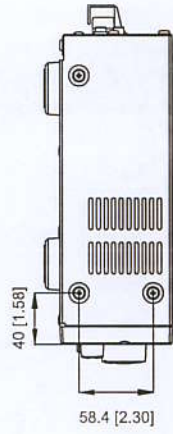

- A-2120 CU

- A-2240 CU

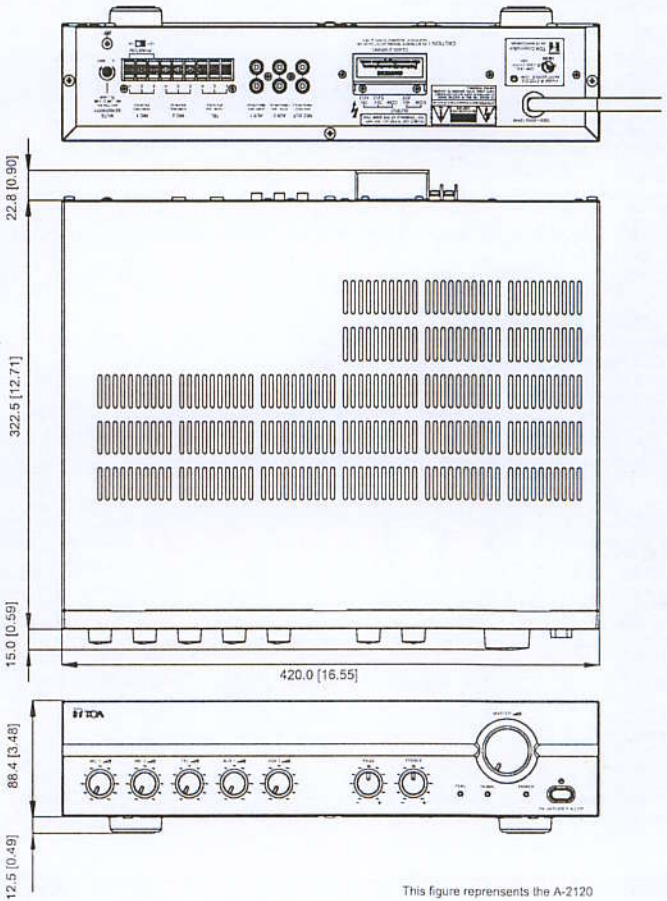
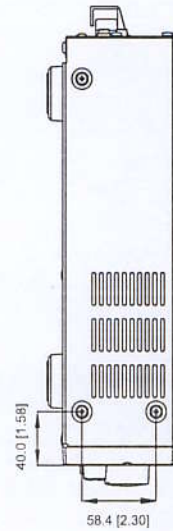

This figure represents the A-2120

12. SPECIFICATIONS

Model No.		A-2060 CU	A-2120 CU	A-2240 CU
Power Source		120 V AC, 60Hz		
Rated Output		60 W	120 W	240 W
Power Consumption (IEC60065)		72 W	124 W	238 W
Frequency Response		50 - 20,000 Hz, ± 3 dB		
Distortion		Less Than 1% at 1kHz, 1/3 Rated Power		
Inputs	MIC 1	-60 dBV (1.0 mV), 600 Ω , Balanced, Screw Terminal		
	MIC 2	-60 dBV (1.0 mV), 600 Ω , Balanced, Screw Terminal		
	TEL	-10 dBV (300 mV), 10 k Ω , Transformer Isolated Balanced, Screw Terminal		
	AUX 1	-20 dBV (100 mV), 10 k Ω , Unbalanced, RCA Pin Jack		
	AUX 2	-20 dBV (100 mV), 10 k Ω , Unbalanced, RCA Pin Jack		
Outputs	Speaker Out	All Speaker Outputs are Floating Balanced		
	70 V	83 Ω	42 Ω	21 Ω
	25 V	10 Ω	5.2 Ω	2.6 Ω
	4 Ω	15.5 V	22 V	31 V
	Rec Out	0 dBV (1.0 V), 600 Ω , Unbalanced, RCA Pin Jack		
Phantom Power		DC +21 V (MIC1)		
S/N Ratio		Over 60 dB		
Tone Controls		Bass: ± 10 dB at 100Hz Treble: ± 10 dB at 10kHz		
Muting		MIC1, MIC2 and TEL overrides other input signals with 30 dB attenuation by voice switch of MIC1, MIC2 or TEL input level. (MIC1, MIC2 and TEL same priority level) Sensitivity Input Level adjustable for Mic1, Mic2: 0 to -64dB, TEL: 0 to -23dB		
Ventilation		-----		Cooling Fan
Indicators		Power LED, Signal LED, Peak LED		
Finish		Panel: ABS Resin, Black Case: Steel Plate, Black		
Dimensions		420(W) x 101(H) x 280(D) mm 16.5(W) x 4.0(H) x 11.0(D) inches	420(W) x 101(H) x 360(D) mm 16.5(W) x 4.0(H) x 14.2(D) inches	
Weight		7.0 kg 15.43 lb	10.8 kg 23.81 lb	13.2 kg 29.10 lb

*) 0 dBV = 1.0 V

**) Specifications are measured on 120V AC for all models.

Note: The design and specifications are subject to change without notice for improvement.