

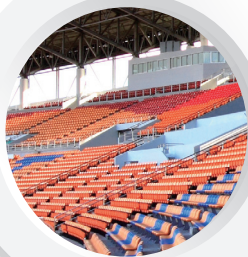

Digital Mixing System

D-2000 Series



Integrating high-performance mixing, matrixing and processing functions to meet a wide scope of sound reinforcement applications

Expandable all-in-one designs ideal offering easy operation, advanced functions and system control capabilities



Expandable to a massive 128 input/output configuration, the D-2000 Series includes various modules and peripherals that can be combined to create the best possible sound in small to medium-size venues of all types, including hotel banquet and function rooms, indoor sports facilities, multipurpose halls and places of worship and many others.

Creating the ideal sound environment

» Auto-mixing advantages

NOM (Number of Open Microphones) - automatically adjusts output level based on the total number of open microphones.
 Ducker function (Auto-Mute function) - automatically works to attenuate outputs of channels with low priority.

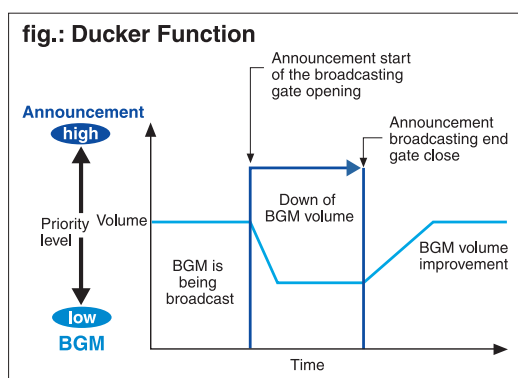

» Highly effective feedback suppression

The D-2000 Series provides feedback elimination for up to 4 channels. In addition, each channel can control 12 problem frequencies. This makes it convenient for feedback suppression in different areas of the same hall.

2 versatile suppression modes Either presettable Auto Mode or realtime Dynamic Mode can be selected to suit the situation and eliminate feedback.

» Essential audio processing

Delay, High-, Low-Pass and Notch Filters, Parametric Equalizers, Compressor/Auto Leveller, Gate, Crossovers and Crosspoint Gain.

User-friendly design facilitates operation by any user

» **32 preset memories for user convenience.**

Up to 32 different routing and parameter configurations can be stored in memory and called up to handle venues such as multi-purpose halls and conference rooms that require frequent changes in staging, seating and speaker arrangements.

» **Intuitive GUI**

The dedicated software's graphic, visually attractive user interface helps streamline settings and adjustments.

» **Mixing console option**

The D-2008SP can be connected via network to the D-2012C mixing console with 12 motorized faders and 8 rotary encoders. This enables simplified mixing operation that suit non-professional users. Using the D-2012C, allows input and output channel signal levels to be monitored, volume changes made as well as recalling preset memory settings, and contact control.

» **VCA control**

D-2000 Series units used in conjunction with the optional D-911 VCA Fader Unit provides more of an analog mixer user interface.

» **RS-232C control**

The RS-232C port allows external control when connected to external devices such as AMX*1 and Crestron*2 control units. This also allows full control over venue lighting and power curtains (blackout) from a central remote location. This feature is particularly suited for AV presentation rooms, conference rooms and hotel banquet rooms.

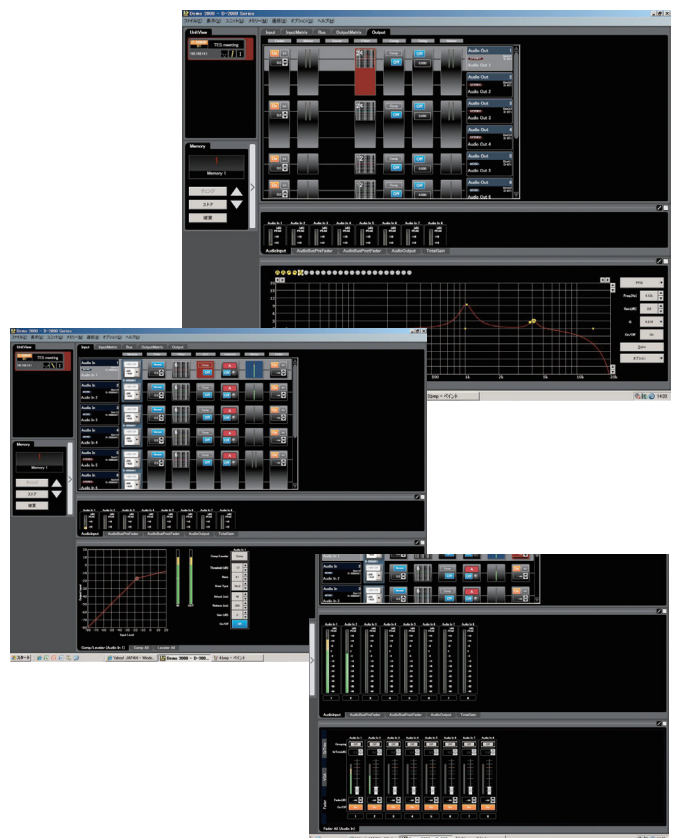

Configuration flexibility and intelligent functions provide solutions for any situation

» **User-specific configurations**

The D-2000 Series fully modular design makes it a simple matter to create a configuration that meets specific user requirements.

» **24-bus matrix**

Totally flexible input-to-output signal routing for zoning or roomcombining as needed.

» **Extending operational use for more advanced applications**

A 128 input/output system can be constructed by connecting four units of the D-2008SP using the CobraNet*3 module. LAN-connected D-2008SP units can be remotely operated from the console or PC software. Up to 4 D-2008SPs and 4 D-2012Cs can be controlled as one system.

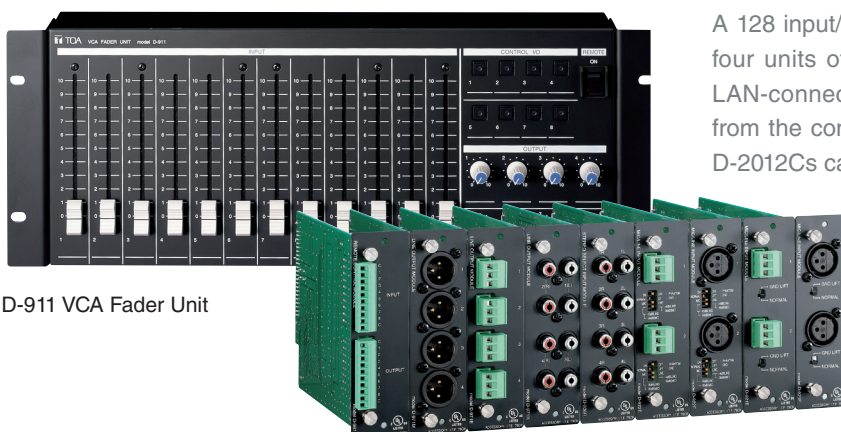

D-911 VCA Fader Unit

*1 AMX is a registered trademark of AMX Corporation.

*2 Crestron is a registered trademark of Crestron Electronics, Inc.

*3 CobraNet is a registered trademark of Cirrus Logic Corporation

Municipal Hall Application

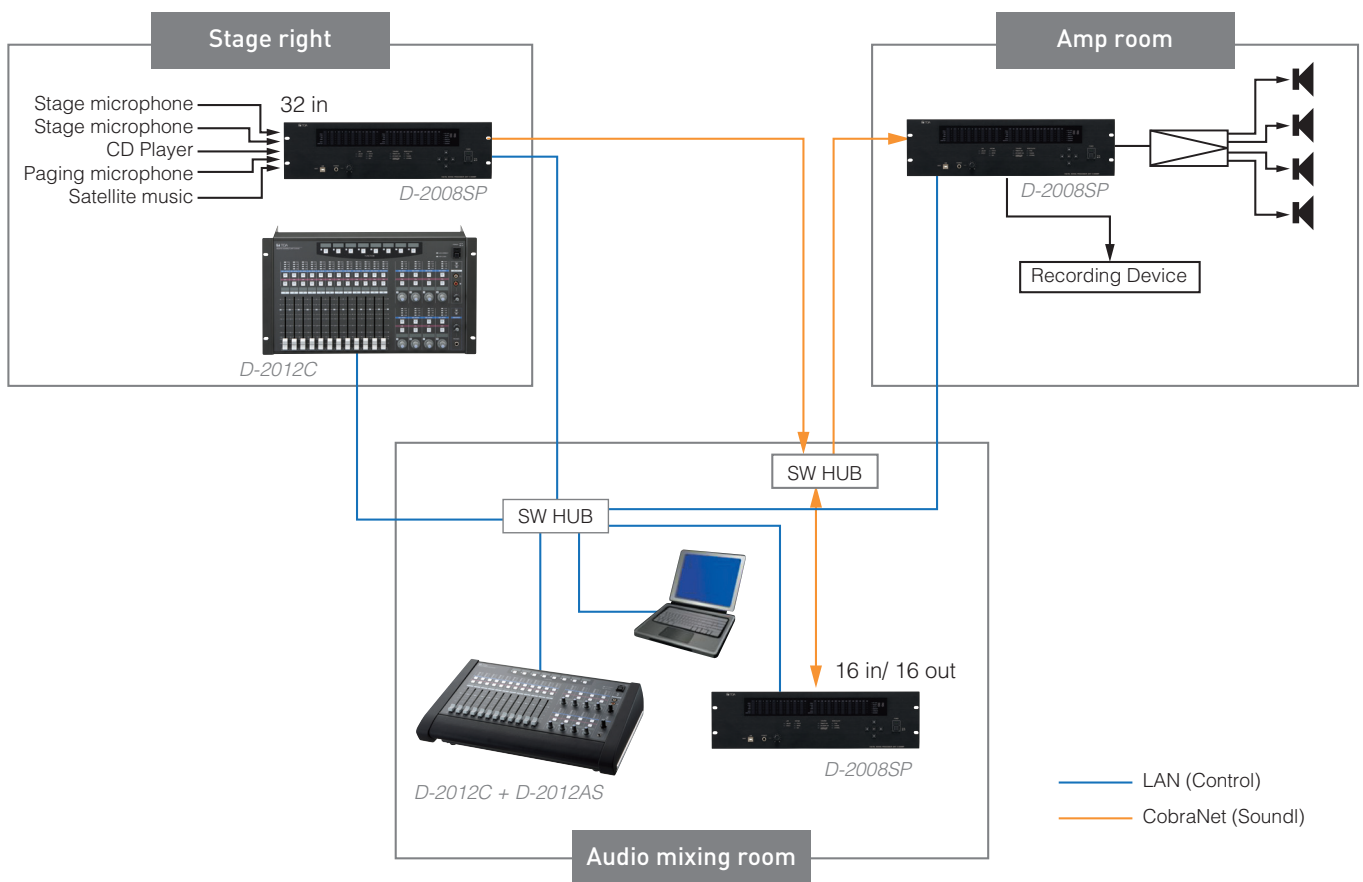
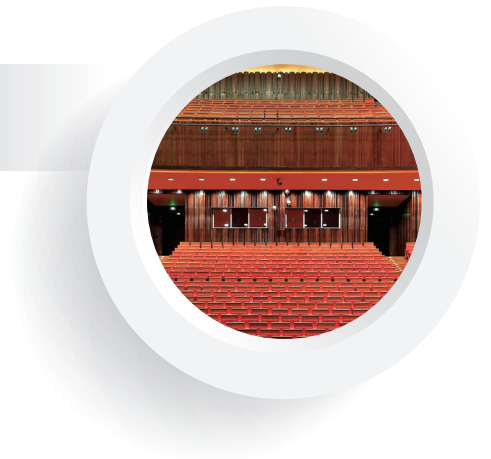

- Decentralized installation of D-2000 Series units via LAN is possible.
- Decentralized mixing system with 16 bus can be configured by CobraNet connection.
- The D-2008SP on the stage right can be controlled remotely by the D-2012C installed in Audio mixing room.
- All connected D-2000 Series components can be monitored and controlled by PC with installed software.

Fitness Club Application

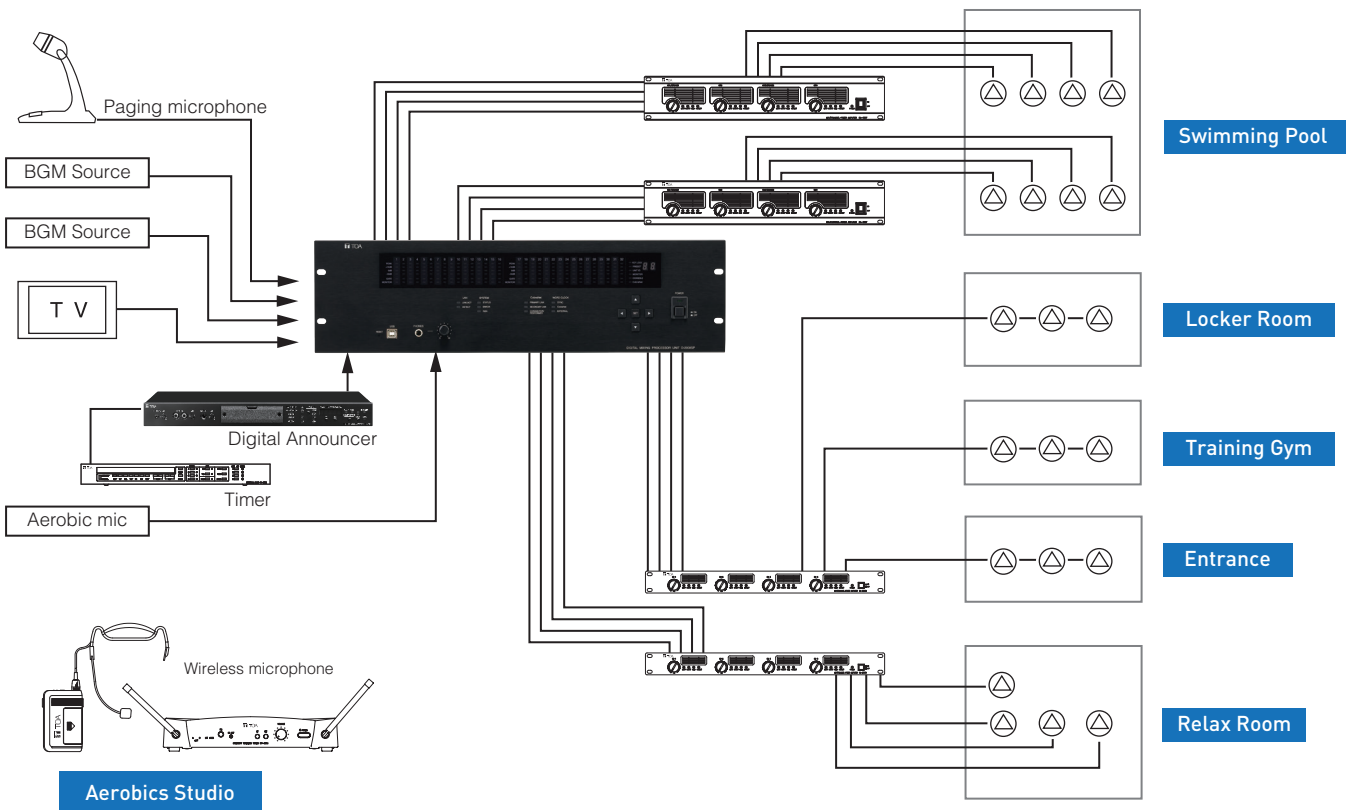

- Users can designate separate zones for broadcast of different audio sources to meet their needs.
- A chime signal can be broadcast in accordance with the schedule of each area.

Applicable Modules

Mic/Line Input Modules (Monaural)



D-2000AD1

- 4-channel, XLR connectors
- A/D converter: 24 bit
- Phantom power supply (48V)
- THD: 0.008% or less

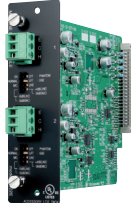

D-921E

- 2-channel, removable terminal block
- A/D converter: 24 bit
- Phantom power supply (15V)
- THD: 0.05% or less



D-921F

- 2-channel, XLR connectors
- A/D converter: 24 bit
- Phantom power supply (15V)
- THD: 0.05% or less

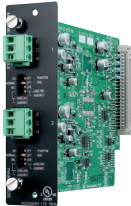

D-922E

- 2-channel, removable terminal block
- A/D converter: 20 bit
- Phantom power supply (15V)
- THD: 0.05% or less



D-922F

- 2-channel, XLR connectors
- A/D converter: 20 bit
- Phantom power supply (15V)
- THD: 0.05% or less

Mic/Line Input Modules (Stereo)



D-936R

- 4-channel, RCA pin jack
- A/D converter: 24 bit
- THD: 0.05% or less



D-923AE

- 2-channel line input
- Applicable format: AES/EBU



D-972AE

- 4-channel line output
- XLR connectors
- Applicable format: AES/EBU

Line Output Modules



D-2000DA1

- 4-channel, XLR connectors
- D/A converter: 24 bit
- THD: 0.008% or less



D-971M

- 4-channel, XLR connectors
- D/A converter: 24 bit
- THD: 0.05% or less



D-971E

- 4-channel, removable terminal block
- D/A converter: 24 bit
- THD: 0.05% or less



D-971R

- 4-channel, RCA pin jack
- D/A converter: 24 bit
- THD: 0.05% or less

VCA Control Module



D-984VC

- Interface to D-911 Remote Controller
- Eight RJ-45 connectors
- Control up to 12 inputs, 8 outputs

D-911 VCA Fader Unit

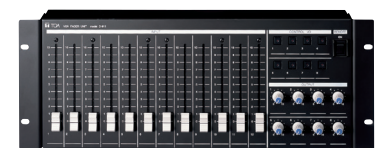

VCA Fader Unit for controlling 12 inputs/8 outputs, channel gains and 8 contact controls when used with the D-984VC.

Remote Control Modules



D-981

- 8 inputs/8 outputs
- Removable terminal block connectors

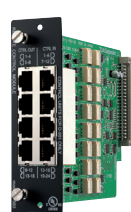

D-983

- 24 inputs/16 outputs
- RJ45 connectors

CobraNet Interface Module



D-2000CB

- Allows audio transmission among D-2008SPs

Appearance



D-2008SP Front



D-2008SP Rear

Specifications

*0 dB = 0.775 V

D-2008SP Digital Mixing Processor Unit	
Power Source	220 - 240 V AC, 50/60 Hz
Power Consumption	76 W
Frequency Response	20 Hz - 20 kHz, ±1 dB (+4 dB* input)
Sampling Frequency	48 kHz
Input and Output	Input: Max. 32 channels, modular construction (modules optional) Output: Max. 32 channels, modular construction (modules optional) Monitor bus: 1 stereo input, 1 stereo output Connector: RJ45 connector Connection cable: Shielded Category 5 or higher twisted pair LAN cable(CAT5-STP) Maximum cable distance: 100 m (between D-2008SP and D-2012C) Headphone: 1 stereo
Signal Processing	
Feedback Suppression Function	12 filters (auto + dynamic), maximum 4 bus channels
Auto-Mixing Function	Ducker (automatic muting), NOM attenuation
Auto-Mixing Group	4 groups
Equalizer/Filter	Parametric equalizer: 20 Hz - 20 kHz, ±15 dB, Q: 0.267-69.249 Filtering: High-pass filter 20 Hz - 20 kHz, 6 dB/oct, 12 dB/oct Low-pass filter 20 Hz - 20 kHz, 6 dB/oct, 12 dB/oct Notch filter 20 Hz - 20 kHz, Q: 8.651 - 69.249 All-pass filter 20 Hz - 20 kHz, Q: 0.267 - 69.249 High shelving filter 6 - 20 kHz, ±15 dB Low shelving filter 20 - 500 Hz, ±15 dB Horn equalizer 20 kHz, 0 to +18 dB (0.5 dB steps) Crossover filter: 20 Hz - 20 kHz, 6 dB/oct, 12 dB/oct, 18 dB/oct, 24 dB/oct
Compressor/Auto-Leveler	(Compressor mode) Threshold: -20 to +20 dB (1 dB steps) Ratio: 1:1, 1.1:1, 1.2:1, 1.3:1, 1.5:1, 1.7:1, 2:1, 2.3:1, 2.6:1, 3:1, 4:1, 5:1, 7:1, 8:1, 10:1, 12:1, 20:1, :1 Attack time: 0.2 ms - 5 s, Release time: 10 ms - 5 s Gain: -∞ to +10 dB Knee type: hard knee, soft knee 1, soft knee 2 (Auto-leveler mode) Target level: -20 to +10 dB (1 dB steps) Maximum gain: 0 to +20 dB (1 dB steps) Attack time: 10 ms - 10 s, Release time: 100 ms - 10 s
Output Delay	Delay time: 0 - 1360 ms (0.021 ms steps)
Bus Delay	Delay time: 0 - 677 ms (0.021 ms steps)
Matrix	Input: Max. 34 (32 + 2) channels x 24 buses, Output: Max. 44 (24 + 4 + 16) buses x 32 channels
CobraNet Matrix	Input: Max. 16 channels x 24 buses, Output: Max. 28 (24 + 4) buses x 16 channels
Crosspoint Gain	-∞ to 0 dB (1 dB steps)
Preset Memory	32
Auxiliary Function	Key Locking function
LAN	Network I/F: 10BASE-T/100BASE-TX (Automatic-Negotiation) Connected via a switching hub Network protocol: TCP/IP Connection cable: Shielded Category 5 or higher twisted pair LAN cable(CAT5-STP) Maximum cable distance: 100m(between D-2008SP and switching hub)
Control	RS-232C: D-sub connector (9 pins) Used for external control Module: Remote control module slot: 2
Operating Temperature	-5 °C to + 40°C (41 °F to 104 °F)
Finish	Panel: Aluminum, hair-line finish, black Case: Surface-treated steel plate
Dimensions (W x H x D)	82 (W) x 132.6 (H) x 343.4 (D) mm (18.98" x 5.22" x 13.52")
Weight	6.3 kg (13.89 lbs.)
Accessory	Power cord (2 m (6.5 ft)) x 1, Rack mounting screw x 4, CD (Set-up software) x 1 Module mounting screw (spare) x 4, Blank panel (preinstalled on the module slot) x 8
Option	Mic/line input module: D-2000AD1, D-921E, D-921F, D-922E, D-922F Stereo select input module: D-936R Digital input module: D-923AE Line output module: D-971E, D-971M, D-971R, D-2000DA1 Digital output module: D-972AE CobraNet interface module: D-2000CB Remote control module: D-981, D-983 VCA control module: D-984VC

D-2012C Remote Console Unit

Power Source	220 - 240 V AC
Power Consumption	18 W
Volume Adjustment	100 mm motorized fader x 12 Rotary encoder x 8
Line Input	1 channel (stereo)
Headphone Output	Stereo 100 mW + 100 mW (32 Ω load)
Monitor Bus	1 stereo input Connector: RJ45 connector Connection cable: Shielded twisted pair (STP) Cat 5 or higher LAN cable (2 pairs of data lines) Maximum cable distance: 100 m (109.36 yd) (between D-2012C and D-2008SP)
LAN	Network I/F: 10BASE-T/100BASE-TX (Automatic-Negotiation) RJ45 connector Network protocol: TCP/IP Connection cable: Shielded twisted pair (STP) Cat 5 or higher LAN cable Maximum cable distance: 100 m (109.36 yd) (between D-2008SP and switching hub)
Control	RS-232C: D-sub connector (9 pins) for maintenance use
Finish	Panel: Surface-treated steel plate Rack mounting bracket: Surface-treated steel plate
Dimensions	482 (W) x 266 (H) x 138 (D) mm (18.98" x 10.47" x 5.43")
Weight	6.6 kg (14.55 lbs)
Accessory	Power cord (2 m (6.5 ft)) x 1 Fader knob (yellow) x 3
Option	Console case: D-2012AS

D-2000AD1 Mic/Line Input Module

Input	4 channels, Mic/Line selectable Mic: -50/-36 dB*, 2.6 kΩ, electronically-balanced Line: -10 dB*, 2.6 kΩ/+4 dB*, 7 kΩ, electronically-balanced Connector: XLR-3-31 equivalent Phantom power supply (48 V DC, can be used when set for the Mic) Ground lift switch
A/D Converter	24 bit
Sampling Frequency	48 kHz
Frequency Response	20 Hz - 20 kHz, ±1 dB (+4 dB* input)
Dynamic Range	104 dB (IHF-A weighted) or more (+4 dB* input)
Total Harmonic Distortion	0.008 % or less (+4 dB* input)
Finish	Panel: Pre-coated steel plate, black, 30 % gloss
Dimensions	35 (W) x 119.5 (H) x 178.4 (D) mm (1.38" x 4.7" x 7.02")
Weight	200 g (0.44 lbs)

D-2000CB CobraNet Interface Module

Network I/F	CobraNet: 100BASE-TX, PRIMARY/SECONDARY 2 system, RJ45 connector, Enables decentralized installation, Audio transmission only Connection cable: Shielded twisted pair (STP) Cat 5 or higher LAN cable To be connected via the specified switching hub Note: This network should be completely independent of other LAN. Number of D-2008SP connection: Max. 4 Switching hub stage: Max. 7 Max extend distance: 100m (328.1 ft) (connected via a switching hub)
Input	16 channels, 20 bit/24 bit
Output	16 channels, 20 bit/24 bit
Sampling Frequency	48 kHz
Finish	Panel: Pre-coated steel plate
Dimensions	25.5 (W) x 82.5 (H) x 144 (D) mm (1" x 3.25" x 5.67") (excluding projection)
Weight	100 g (0.22 lbs)
Accessory	Screw x 1

D-2000DA1 Line Output Module

Output	4 channels, +4 dB*/-10 dB* (changeable), adaptable load of 600 Ω or more, balanced (electronically-balanced)/unbalanced (changeable), XLR-3-32 equivalent
D/A Converter	24 bit
Sampling Frequency	48 kHz
Frequency Response	20 Hz - 20 kHz, ±1 dB
Dynamic Range	104 dB (IHF-A weighted) or more
Total Harmonic Distortion	0.008 % or less
Finish	Panel: Pre-coated steel plate, black, 30 % gloss
Dimensions	35 (W) x 119.5 (H) x 178.4 (D) mm (1.38" x 4.7" x 7.02")
Weight	200 g (0.44 lbs)

D-2012AS Console Case (for desk-top use)

Finish	Side Panel: MDF, black, paint, mat Armrest: MDF, synthetic-leathered, black, mat Decorative panel: Stainless steel, silver
Dimensions	505 (W) x 127.5 (H) x 333.4 (D) mm (19.88" x 5.02" x 13.13")(assembled)
Weight	2.3 kg (5.07 lb) (assembled: 7.5 kg (16.53 lb))
Accessory	Assemble screw...11, Rubber foot...4, Rubber foot mounting screw...4



D-2012C with D-2012AC